



## SWiFT & SWiFT plus Operating Manual



Document ID      MANUAL-68251662-9  
Date:              April 2021

This confidential document was prepared by the staff of Valeport Limited, the Company, and is the property of the Company, which also owns the copyright therein. All rights conferred by the law of the copyright and by virtue of international copyright conventions are reserved to the Company. This document must not be copied, reprinted or reproduced in any material form, either wholly or in part, and the contents of this document, and any method or technique available there from, must not be disclosed to any other person whatsoever without the prior written consent of the Company.

© 2021 Valeport Ltd

Valeport Ltd  
St Peter's Quay  
Totnes TQ9 5EW  
United Kingdom

Phone: +44 1803 869292  
email: [sales@valeportwater.co.uk](mailto:sales@valeportwater.co.uk)  
Web: [www.valeportwater.co.uk](http://www.valeportwater.co.uk)

As part of our policy of continuous development, we reserve the right to alter, without prior notice, all specifications, designs, prices and conditions of supply for all our equipment

# Contents

1	SWiFT Profilers - Introduction.....	1
2	SWiFTplus – Profiler with Optical Sensor .....	2
3	Sensors .....	3
3.1	Sound Velocity Measurement .....	3
3.2	Conductivity .....	3
3.3	Temperature .....	3
3.4	Pressure Sensor.....	3
3.5	Optical Sensors .....	4
3.5.1	Fluorometers .....	4
3.5.2	Turbidity.....	7
3.6	Calculated Parameters.....	7
3.6.1	SWiFT SVP .....	7
3.6.2	SWiFT CTD .....	8
3.7	Operational Battery Life.....	9
4	Physical Characteristics.....	10
4.1	SWiFT and SWiFTplus.....	10
4.2	Dimensions - SWiFT SVP .....	10
4.3	Dimensions - SWiFT SVPplus .....	10
4.4	Dimensions - SWiFT CTD .....	11
5	Rechargeable Battery .....	12
5.1	Charging .....	13
5.1.1	Charging Status.....	13
5.1.2	Charging from a Laptop USB Port .....	14
5.1.3	Battery Life Expectancy .....	14
5.2	Shipping Your SWiFT with Lithium Ion Batteries .....	14
5.2.1	Lithium Ion Battery Certification.....	15
6	Operation.....	16
6.1	Software.....	16
6.1.1	Valeport Ocean Software .....	16
6.2	Interfacing a SWiFT .....	17
6.3	Interfacing to a PC – Valeport Ocean Software.....	17
6.3.1	USB Communications .....	17
6.3.2	Bluetooth Communications.....	17
6.4	Configuration .....	19
6.5	Operational Status:.....	19
6.5.1	GPS Status.....	19
6.5.2	Battery Status.....	20
6.5.3	Bluetooth Status .....	20
6.6	Operational Modes .....	20
6.6.1	Smart Profile Mode.....	20
6.6.2	Continuous Mode .....	24
6.7	Optical Sensor Test- SWiFT plus.....	25
6.8	Tare.....	26
6.9	Do Not Deploy Flag .....	26
6.10	Status Message.....	27
6.11	Data File .....	27
6.11.1	Basic Structure: .....	27
6.12	Data File Translation .....	28
6.13	Real Time Data Format.....	28

7	Power Saving Modes.....	30
7.1	Auto Power Saving Mode:.....	30
7.1.1	Manual setting of Auto Power Mode.....	30
7.2	Bluetooth Sleep Mode in Valeport Ocean.....	31
7.2.1	Bluetooth Sleep Mode Detail – Manual Operation (Post September 2019).....	32
7.2.2	Low Power Mode Detail - Pre September 2019.....	32
8	Care and Maintenance .....	33
8.1.1	Long Term Storage.....	33
9	Upgrading Your SWiFT.....	34
9.1	Valeport SWiFT - Firmware Upgrade.....	34
9.1.1	Step 1 - Download the Required Files.....	34
9.1.2	Step 2 - Update the Firmware.....	35
9.2	Bluetooth Adapter - Re-Program and Pair .....	38
10	Ordering and Part Numbers.....	40
10.1	SWiFT SVP.....	40
10.2	SWiFT CTD .....	41
11	Declarations of Conformity .....	42
11.1	SWiFT and SWiFT plus.....	43
11.1.1	EU Declaration of Conformity .....	43
11.1.2	UK Declaration of Conformity .....	44
11.2	SWiFT Bluetooth Module - Qualifications and Approvals.....	46
11.2.1	European Union Regulatory Compliance .....	46
11.2.2	Safety Compliance .....	46
11.2.3	FCC and IC Compliance.....	46
11.2.4	FCC Statement.....	47
11.2.5	Labelling Requirements for End Product .....	47
11.2.6	FCC and IC IDs .....	48
11.2.7	Bluetooth Qualification Information.....	48
11.2.8	Japan Radio Equipment Compliance .....	49
11.2.9	NCC Taiwan Compliance .....	49
11.2.10	KCC South Korea Compliance .....	49
11.2.11	Anatel Brazil Compliance .....	50
11.2.12	Australia and New Zealand Regulatory Compliance .....	50
11.2.13	South Africa Regulatory Compliance.....	50
11.2.14	Antennas .....	51
11.2.15	Compliance with the RoHS directive .....	51
11.3	PC Bluetooth Module .....	52
11.3.1	EU Declaration of Conformity .....	52
11.3.2	FCC Statement.....	52
11.3.3	Radio Frequency Exposure .....	52
11.3.4	Potentially Explosive Atmospheres.....	52
11.4	World USB Charger – 2.4A .....	53

## Important Information

The SWiFT must only be deployed with the suspension spar securely fitted as shown below

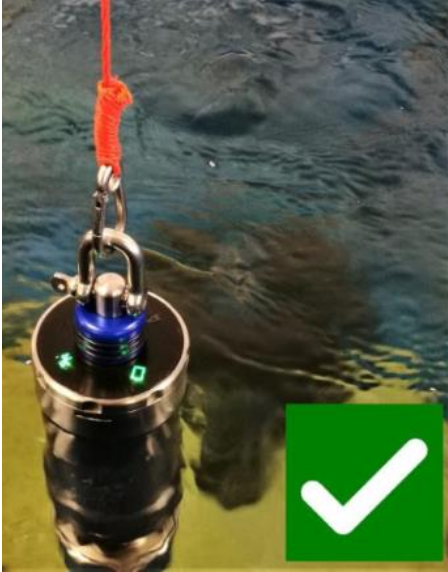

Never deploy the instrument with the USB cable connected



If the equipment is used in a manner not specified by the manufacturer the protection provided by the equipment may be impaired.

The safety of any system incorporating the equipment is the responsibility of the assembler of the system.

In the event that your SWiFT should be required to be disposed of Valeport is WEEE Compliant  
For disposal instructions please contact Valeport.

# 1 SWiFT Profilers - Introduction

The SWiFT profiler is available in two main forms – SVP and CTD. The SVP is fitted with sound velocity, temperature and pressure sensors, the CTD is fitted with conductivity, temperature and pressure sensors. Configuration and data download is via dedicated Valeport Ocean software - PC or mobile device and can be integrated into 3<sup>rd</sup> party software if required.



SWiFT SVP



SWiFT CTD

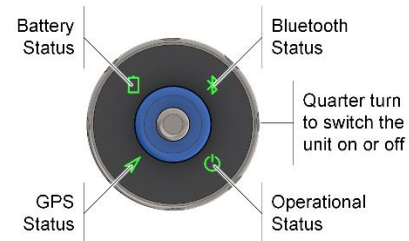

Designed from the outset for a seamless workflow, SWiFT profilers provide survey-grade sensor technology coupled with the convenience of Bluetooth connectivity and rechargeable batteries, an integral GPS module, to geo-locate each profile, completes the package. Data can be easily and quickly downloaded and reviewed wirelessly, via Bluetooth, using the either Valeport's Ocean for PC or mobile for portable devices and instantly shared, in industry standard formats through email and cloud services. Alternatively, use the provided USB data and charging cable to connect to Valeport's Ocean software package.

In addition to the directly measured sound speed, temperature and pressure observations of the SVP version, Conductivity, Salinity and Density are calculated using Valeport's proprietary algorithm developed from extensive laboratory and field work;

For the Swift CTD, sound speed, salinity and density are calculated from the Conductivity, temperature and pressure data.

With a minimum battery life of 5 days continuous use, in profiling mode and the convenience of charging via USB, SWiFT is intended for coastal, harbour and inland hydrographic survey use and offers the highest quality profiles in a compact, robust and portable package.

## Key Features

- Self-contained SVP or CTD profiling system
- Lithium Ion rechargeable battery
- Depth rated to 500m
- LED symbols to identify:
  - Instrument status
  - Battery Status
  - GPS Status
  - Bluetooth Status
- Bluetooth connectivity to PC, iOS and Android App.
- Automatic reacquisition of Bluetooth connection and file download on recovery
- GPS Geo-Location and time
- 2Gb memory  
(> 25,000, 0.1m separated observation profiles)
- Deployment cage that will not interfere with sensor performance and allow extra weight to be attached

## Applications

A shallow water, self-contained profiler.

Possible applications include:

- Coastal, harbour and inland hydrographic survey
- Marine Construction
- Academic and Scientific Survey
- Sound velocity profiling
  - Single Beam echo-sounder
  - Multi-Beam echo-sounder
  - USBL
  - Imaging sonar
- Lake, reservoir and river studies

## 2 SWiFTplus – Profiler with Optical Sensor



Extending the SWiFT SVP's functionality still further the SWiFT SVPplus offers all the operational capability of SWiFT with the addition of an optical sensor.

### Key Features

- Everything a SWiFT can do plus
- An optical sensor:
  - Turbidity
  - Chlorophyll a
  - Fluorescein
  - Sulforhamine B
  - Rhodamine WT
  - Phycocyanin

### Applications

A shallow water, self-contained profiler, possible applications include:

- Physical Oceanography
- Academic/Research studies
- Environmental and ecological surveys
- Lake, reservoir and river studies
- Coastal, harbour and inland hydrographic survey
- Sound velocity profiling (using calculated speed of sound in water)
  - Single Beam echo-sounder
  - Multi-Beam echo-sounder
  - USBL
  - Imaging sonar

## 3 Sensors

### 3.1 Sound Velocity Measurement

Utilising Valeport's latest sound velocity sensor, each measurement is made using a single pulse of sound travelling over a precisely known distance, so is independent of the inherent calculation errors present in CTD calculated data. Valeport's unique digital signal processing technique virtually eliminates signal noise, and gives almost instantaneous response; the digital measurement is also entirely linear, giving predictable performance under all conditions.

Range:	1375 - 1900m/s
Resolution:	0.001m/s
Accuracy:	±0.020m/s
Response:	31.25 ms

### 3.2 Conductivity

The inductive conductivity sensor is optimised for water flow through to allow for minimal disturbance to the water column while rapidly descending to the required depth.

Range:	0 - 80 mS/cm
Resolution:	0.001 mS/cm
Accuracy:	±0.01 mS/cm
Response:	31.25 ms

### 3.3 Temperature

The SWiFT SVP is fitted with PRT temperature sensor.

The SWiFT CTD is fitted with fast response Thermistor temperature sensor.

Type:	PRT   Thermistor
Range:	-5°C to +35°C
Accuracy:	±0.01°C
Resolution:	0.001°C
Response	PRT: 500 ms Thermistor: <100 ms

### 3.4 Pressure Sensor

A 500m rated piezo-resistive pressure transducer:

Type:	Strain Gauge
Accuracy:	±0.01% full range
Resolution:	0.001
Response	31.25 ms

### 3.5 Optical Sensors

An optical sensor must be kept clean to operate correctly. Ensure that the SWiFT plus is powered down before cleaning the sensor.

Use warm soapy water with a soft bristled brush to remove any light fouling.

For heavy fouling use a solvent (e.g Isopropyl alcohol) and a soft bristled brush.

Always rinse thoroughly after every use in clean, fresh water.

#### 3.5.1 Fluorometers

##### 3.5.1.1 Safety Statement

A Valeport Fluorometer is classified as Risk Group 1 under standard 62471. As the type is classified as Risk Group 1 solely due to radiation in the visible band a hazard label is not required. However,

- the LED used is in excess of the Exempt Group and that the viewer-related risk is dependent upon how the user installs and operates the equipment.
- The exposure hazard value (EHV) for a Valeport Fluorometer in terms of distance is 320mm.

Never look directly into the optical aperture

##### 3.5.1.2 Chlorophyll a

	Performance
Excitation:	470 nm
Detection:	696 nm
Dynamic Range:	0 - 800 µg/l
Instrument Detection limit:	0.025 µg/l*
Actual Detection limit:	0.025 µg /l**
Linearity:	0.99 R <sup>2</sup>
Response Time:	0.03 to 2 sec

\* 3x SD in RO water

\*\* calibrated against Chlorophyll a in acetone solution

##### 3.5.1.3 Fluorescein

	Performance
Excitation:	470 nm
Detection:	545 nm
Dynamic Range:	0 - 500 ppb
Instrument Detection limit:	<0.01 ppb*
Actual Detection limit:	0.03 ppb**
Linearity:	0.99 R <sup>2</sup>
Response Time:	0.03 to 2 sec

\* 3x SD in RO water

\*\* Calibrated against Fluorescein solution



### 3.5.1.4 Rhodamine

	Performance
Excitation:	520 nm
Detection:	650 nm
Dynamic Range:	0 - 1000 ppb
Instrument Detection limit:	<0.01 ppb*
Actual Detection limit:	0.06 ppb**
Linearity:	0.99 R <sup>2</sup>
Response Time:	0.03 to 2 s

\* 3x SD in RO water

\*\* Calibrated against Rhodamine WT solution

### 3.5.1.5 Sulforhodamine B

	Performance
Excitation:	520 nm
Detection:	650 nm
Dynamic Range:	0 - 500 ppb
Instrument Detection limit:	<0.01 ppb*
Actual Detection limit:	0.06 ppb**
Linearity:	0.99 R <sup>2</sup>
Response Time:	0.03 to 2 s

\* 3x SD in RO water

\*\* Calibrated against Sulforhodamine B solution

### 3.5.1.6 Phycocyanin

	Performance
Excitation:	590 nm
Detection:	650 nm
Dynamic Range:	0 - 9000 ppb
Instrument Detection limit:	<0.01 ppb*
Actual Detection limit:	2 ppb**
Linearity:	0.99 R <sup>2</sup>
Response Time:	0.03 to 2 s

\* 3x SD in RO water

\*\* Calibrated against Sulforhodamine solution

### 3.5.1.7 Linear Observation Range

The linear range is the concentration range for which the fluorometer signal is directly proportional to the concentration of the fluorophore. The linear range starts at the minimum detection limit (MDL) and extends to the upper limit of the instrument (dependent on fluorophore properties, optical filters, LED power, sample volume and optical path length).

The optical devices manufactured by Valeport have digital outputs only; at higher concentrations, unlike analogue devices which generally flat-line at full-scale deflection (e.g. FSD 5V) the fluorometer will continue to output a signal which increases with concentration (i.e. meaningful data), though which is no longer guaranteed to be linear.

At very high fluorophore concentrations, signal quenching can occur, whereby the instrument output does not increase linearly with fluorophore concentration (roll-off) and may decrease at even higher levels.

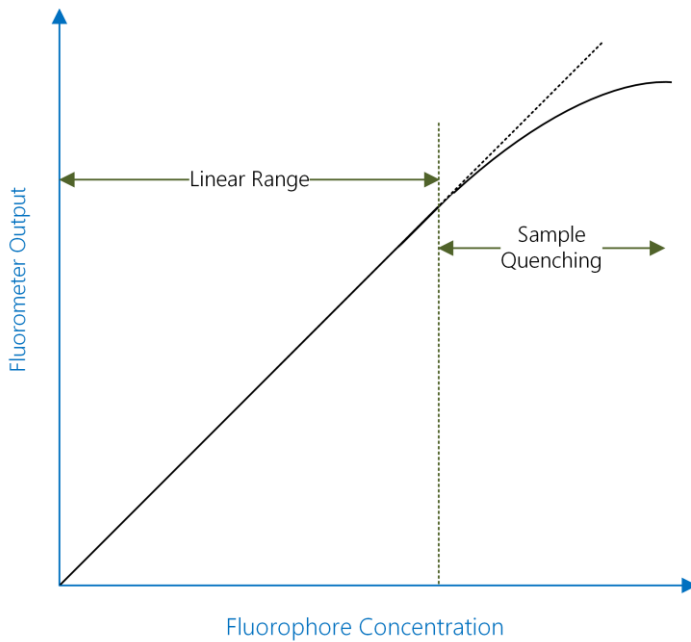

To perform a quick linearity check, dilute a sample of dye 1:1 with RO water. If the reading decreases by 50%, the sample is in the linear range. If the reading decreases by less than 50% or even increases, the sample is above the linear range.

#### 3.5.1.7.1 Quenching

Quenching refers to the reduction in fluorescence of a fluorophore. Several processes can result in quenching:

Chloride is known to quench quinine sulphate and Fluorescein. It is, therefore, advisable to prepare any fluorophore solutions with Reverse Osmosis (RO) or De-Ionised (DI) water.

Temperature quenching - as the temperature of the sample increases, the fluorescence decreases, that is, fluorescence is sensitive to temperature. In order to improve accuracy, measure the sample at different temperatures and derive corrections for changes in temperature.

Photo-bleaching (or fading) is the (permanent) degradation of a fluorophore molecule by light resulting in lower signal levels. Photo-bleaching is dependent on exposure (intensity of light and duration) and wavelength (UV is more damaging than longer wavelengths). Use of more robust fluorophores is recommended to avoid photo-bleaching.

### 3.5.2 Turbidity

Valeport's Turbidity technology is essentially two sensors in one. The first is a “classic” nephelometer, using a 90° beam angle for turbidity levels between 0 and 2000 NTU. The second sensor uses optical backscatter - OBS (~120° beam angle) for turbidity levels beyond 10 000 NTU. Both sensors output data simultaneously, at a programmable rate, so there is no need to switch ranges as conditions vary. Intelligent sampling and the use of a 24 bit ADC eliminates the need to switch gain. The optical head is very compact, measuring just 20mm diameter and is rated to full ocean depth.

Excitation\Detection:	850nm
Linear Range:	Nephelometer 0 to >1 000 NTU - linear response Optical Backscatter: 0 to 4 000 NTU - linear response (>4,000 NTU has a non-linear monotonic response that allows derivation of higher values using look-up tables)
Minimum Detection Level	0.03 NTU

#### 3.5.2.1 Safety Statement

The Turbidity sensor is classified EXEMPT under the standard 62471.

As a Valeport Turbidity sensor is classified as EXEMPT a hazard label is not required.

Never look directly into the optical aperture

## 3.6 Calculated Parameters

### 3.6.1 SWiFT SVP

#### 3.6.1.1 Calculated Conductivity

From directly measured sound velocity, temperature and pressure, SWiFT calculates Salinity using a proprietary Valeport algorithm developed from extensive laboratory and fieldwork. This salinity value is then used to compute conductivity using standard EOS80 formulas.

Type:	Calculated
Accuracy:	±0.05 mS/cm
Resolution:	0.001 mS/cm

#### 3.6.1.2 Calculated Salinity

From directly measured sound velocity, temperature and pressure, SWiFT calculates Salinity using a proprietary Valeport algorithm developed from extensive laboratory and fieldwork.

[A new salinity equation for sound speed instruments - Allen - 2017 - Limnology and Oceanography: Methods - Wiley Online Library](https://aslopubs.onlinelibrary.wiley.com/doi/pdf/10.1002/lom3.10203)

<https://aslopubs.onlinelibrary.wiley.com/doi/pdf/10.1002/lom3.10203>

Type:	Calculated
Accuracy:	±0.05 PSU
Resolution:	0.001 PSU

### 3.6.1.3 Calculated Density

From directly measured sound velocity, temperature and pressure, SWiFT calculates Salinity using a proprietary Valeport algorithm developed from extensive laboratory and fieldwork. This salinity value is then used to compute Density using standard EOS80 formulas.

Type:	Calculated
Accuracy:	$\pm 0.05 \text{ kg/m}^3$
Resolution:	$0.001 \text{ kg/m}^3$

## 3.6.2 SWiFT CTD

### 3.6.2.1 Calculated Sound Speed

From directly measured conductivity, temperature and pressure, sound speed is calculated using standard EOS80 formulas.

Type:	Calculated
Accuracy:	$\pm 0.025\text{-}0.30 \text{ ms}^{-1}$ (Chen & Millero)
Resolution:	$0.001 \text{ ms}^{-1}$

### 3.6.2.2 Calculated Salinity

From directly measured conductivity, temperature and pressure, salinity is calculated using standard EOS80 formulas.

Type:	Calculated
Accuracy:	$\pm 0.01 \text{ PSU}$
Resolution:	$0.001 \text{ PSU}$

### 3.6.2.3 Calculated Density

From directly measured conductivity, temperature and pressure, density is calculated using standard EOS80 formulas.

Type:	Calculated
Accuracy:	$\pm 0.01 \text{ kg/m}^3$
Resolution:	$0.001 \text{ kg/m}^3$

### 3.7 Operational Battery Life

It can be assumed that a SWiFT SVP and SWiFT CTD use a similar amount of energy during operation. For the SWiFTplus calculations a worst-case scenario is used – Chlorophyll a.

These calculations are an indication only and actual performance will depend on a number of factors not modelled in this calculation.

#### Scenario 1 – Light Duty Cycle

2 profiles per day: am\pm  
 Profile Depth: 50m  
 Drop rate: 1 m/s  
 Recovery Rate: 0.5m/s  
 SWiFT turned off between profiles

Endurance:

SWiFT	SWiFTplus
1011 profiles	734 profiles
505 days operation	367 days operation

#### Scenario 2 – Medium Duty Cycle

24 profiles per day: once an hour, every hour  
 Profile Depth: 100m  
 Drop rate: 1 m/s  
 Recovery Rate: 0.5m/s  
 SWiFT turned off between profiles

Endurance:

SWiFT	SWiFTplus
1493 profiles	738 profiles
62 days operation	30 days operation

#### Scenario 3 – Heavy Duty Cycle

72 profiles per day: once every 20 minutes  
 Profile Depth: 200m  
 Drop rate: 1 m/s  
 Recovery Rate: 0.5m/s  
 SWiFT placed in Bluetooth Sleep mode between profiles

Endurance:

SWiFT	SWiFTplus
810 profiles	393 profiles
11 days operation	5.5 days operation

In a worst-case scenario, Chlorophyll a, a fully charged battery will operate for, in excess of 70 hours; but no more than this should be planned for.

## 4 Physical Characteristics

### 4.1 SWiFT and SWiFTplus

Housing & Bulkhead:	Titanium
Deployment Weight:	Stainless Steel (SWiFT SVP AND SWiFT SVPplus only)
Integral Cage	Acetal (SWiFT CTD AND SWiFT CTDplus only)
Depth Rating:	500m (from September 2019)
Weight:	2.0kg (in air) / 0.9kg (in water) 3.0kg (in air) / 1.8kg (in water) with optional deployment weight

### 4.2 Dimensions - SWiFT SVP

Please refer to Valeport for more detailed dimensions if required.

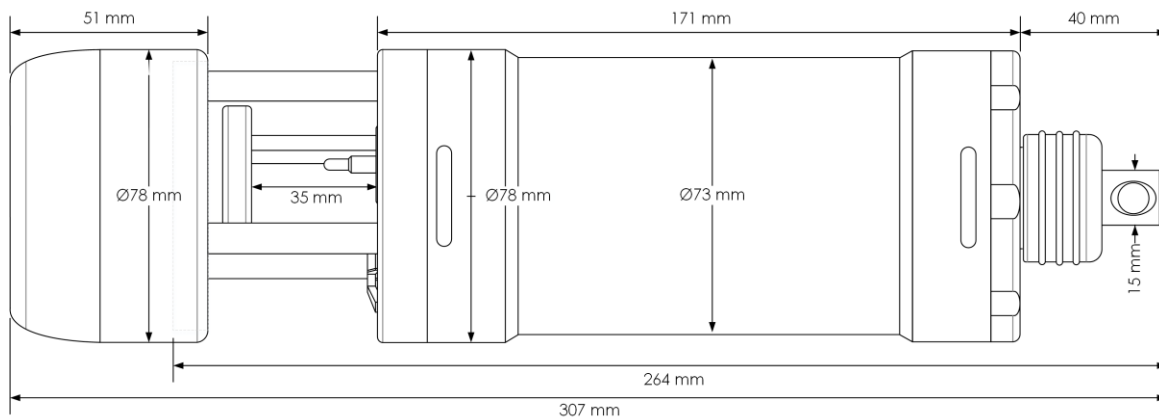

### 4.3 Dimensions - SWiFT SVPplus

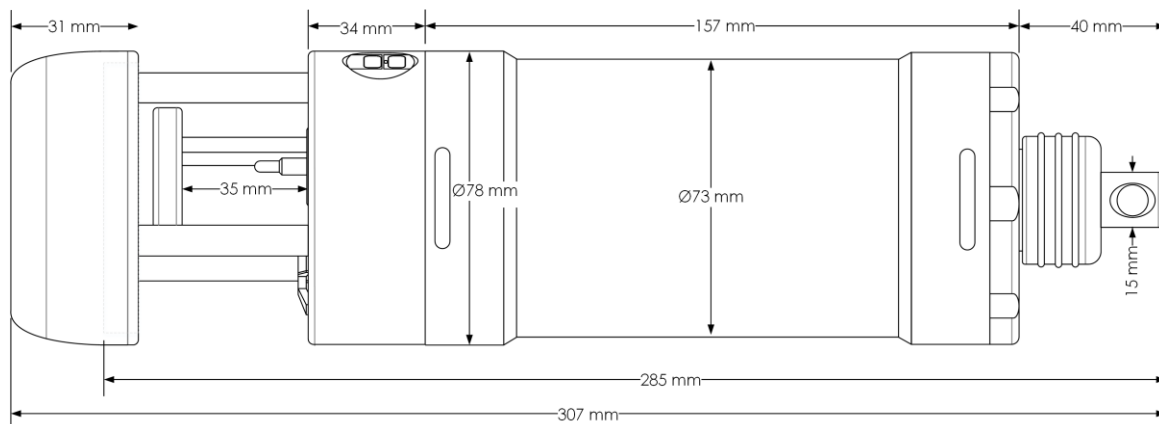

#### 4.4 Dimensions - SWiFT CTD

Please refer to Valeport for more detailed dimensions if required.

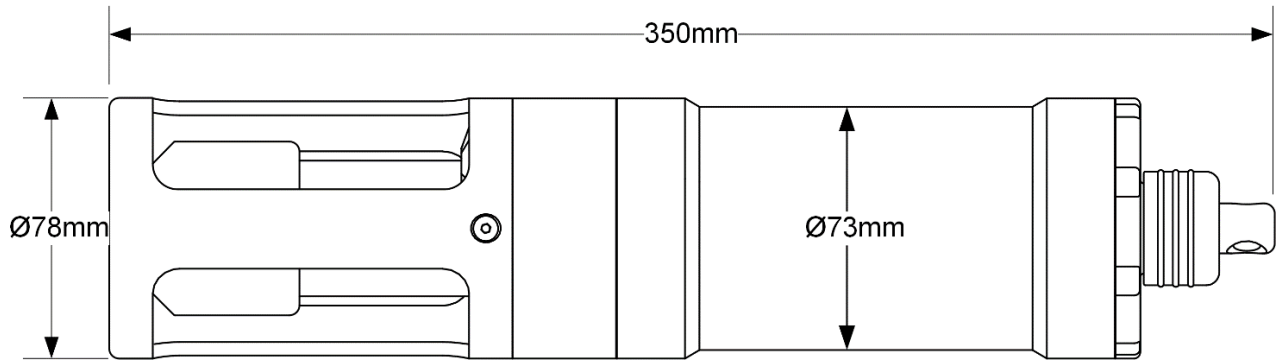

## 5 Rechargeable Battery

The SWiFT is fitted with a rechargeable battery with the following characteristics:

Battery:	Internal, Rechargeable Lithium Ion Battery Pack
Capacity	Total Capacity 12Ah. Available Capacity: 10 Ah
Charging:	USB 1.5A Charger that is supplied 0.5A Laptop USB port
Battery Life:	Up to 5 continuous operation from a fully charged pack (standard SWiFT)

As the battery becomes discharged the SWiFT status LEDs will change during operation:

Solid Green	More than 24 hours
Solid Amber	less than 24 hours but more than 12 hours
Solid Red	Less than 12 operational hours

The actual number of operational hours can vary from one project scenario to another and if a SWiFT plus is being used. Environmental factors have to be considered as well as the age of the battery, the time the SWiFT is switched on as well as the time in the water all have to be taken into consideration.

Below is a table of the current drawn by the SWiFT in various modes:

Mode	Bluetooth	GPS	Current mA
Running on the surface	ON	ON	83
Running on the surface	Connected	ON	102
Interrupted	Connected	ON	100
Running sub surface	OFF	OFF	55
Turned off	OFF	OFF	0.5
Bluetooth Sleep	ON	OFF	7

### SWiFTplus

Mode	Bluetooth	GPS	Current mA
Running on the surface	ON	ON	156
Running on the surface	Connected	ON	156
Interrupted	Connected	ON	155
Running sub surface	OFF	OFF	122
Turned off	OFF	OFF	0.5
Bluetooth Sleep	ON	OFF	7

Note:

- Current is still drawn when the SWiFT is switched off or in Sleep mode
- The current drawn is considerably less when sub surface, recording sound velocity, pressure and temperature data than on the surface when GPS and Bluetooth are active
- GPS and Bluetooth are disabled as the pressure reading passes a trigger depth



## 5.1 Charging

The battery pack is supplied with a dedicated USB charging and data download interface cable, this must be used.

In order to gain access to the charging socket the lock nut and suspension spar must be removed - see illustration on the inside of the transit case lid. Pay special attention to the O ring seals during dis-assembly and most importantly reassembly to insure a fully water tight seal. When replacing the suspension spar and lock nut do not over tighten either thread. Finger tight is tight enough.

The suspension spar contains a vent hole in case of pressure build up in the housing. This venting hole must be kept clean and clear. If the SWiFT is used in a manner not specified by Valeport the protection provided by the equipment might be impaired.



The supplied USB charger is capable of charging the battery with a 1.5 A current.

The battery pack has intelligent charging and discharge circuitry. There is no 'memory' to the pack so partial charging sessions will not reduce the capacity or life of the pack. The capacity of the pick will, however, reduce with age.

It is advised that the SWiFT battery is never allowed to become fully discharged. In a fully discharged state the battery is open circuit. In order to reduce the chances of battery becoming fully discharged the SWiFT will disable all sensors with 1 hour's operational charge left. From disabling the sensors, you have approximately 100 hours to start a charging session to prevent the battery becoming open circuit.

If the battery is completely discharged and, therefore, open circuit it will take 50 minutes, using the supplied 1.5A charger, to start taking on a charge. Please note, during this 50 minute period of charging no LEDs will be lit.

If charged for 1 hour from a near flat but not an open circuit state, using the supplied 1.5A charger, the battery will take on a charge that will allow the SWiFT to operate for approximately 12 hours.

It will take approximately 12 hours, using the supplied 1.5A charger, to fully charge the battery from a near flat but not open circuit state.

When the charging session is complete, disconnect the charging cable from the SWiFT before disconnecting power from the charger.

### 5.1.1 Charging Status

During charging the status of the process can be monitored:

Flashing Red	Charging < 12 hours capacity
Flashing Amber	Charging at > 12 hours capacity < 24 hours capacity
Flashing Green	Charging > 24 hours capacity
Solid Green	Fully charged or running with charger on

### 5.1.2 Charging from a Laptop USB Port

A typical Laptop USB port is rated to supply up to 0.5A for charging, although many newer laptops have dedicated USB sockets (usually marked yellow) that often are capable of higher output currents. The SWiFT's electronics is able to detect the higher current available resulting in faster charging cycles. The SWiFT also maintains the maximum charge voltage at a reduced level, resulting in longer battery life.

Any charging operation from a standard USB port will take approximately three (3) times longer than if the supplied 1.5A rated charger is used as described above.

### 5.1.3 Battery Life Expectancy

The batteries installed in the SWiFT will lose capacity over time. Lithium-ion batteries use the movement of ion particles to create and store an electrical charge. Eventually these ion particles are trapped and can no longer move around. The batteries then lose their capacity to store energy.

Under normal operational conditions the SWiFT battery pack should offer a practical, usable capacity for a period in excess of 4 years.

## 5.2 Shipping Your SWiFT with Lithium Ion Batteries

The Lithium Ion battery within this product, when packed and shipped in its transit box, conforms to UN3481, PI967 section II and its additional requirements.

No battery handling labels are required.

For further information, please contact Valeport and ask for one of the Dangerous Goods in shipment advisers or visit the IATA website page:

<http://www.iata.org/whatwedo/cargo/dgr/Pages/lithium-batteries.aspx>

### 5.2.1 Lithium Ion Battery Certification



#### Supplier's Declaration of Conformity

<b>SAP No.:</b> 241740 <b>Model name:</b> Li18650-31 1s4p+BQ27541-G1 fuel gauge 3.7V 12.4Ah 45.88Wh	
<input type="checkbox"/> Lithium metal	<input checked="" type="checkbox"/> Lithium-ion
<input type="checkbox"/> cell	<input checked="" type="checkbox"/> battery (pack)
Lithium content or Watt-hour rating:	
<input type="checkbox"/> batteries > 0.3g(Lithium metal or Lithium alloy), 2.7Wh(Li-ion) <input type="checkbox"/> batteries ≤ 0.3g(Lithium metal or Lithium alloy), 2.7Wh(Li-ion) <input type="checkbox"/> cells > 1g (Lithium metal or Lithium alloy), 20Wh (Li-ion) <input type="checkbox"/> cells ≤ 1g (Lithium metal or Lithium alloy), 20Wh (Li-ion) <input type="checkbox"/> batteries > 2g(Lithium metal or Lithium alloy), 100Wh(Li-ion) <input checked="" type="checkbox"/> batteries ≤ 2g(Lithium metal or Lithium alloy), 100Wh(Li-ion)	

Test results in accordance with the UN Manual of Test and Criteria ST/SG/AC.10/11 Rev.5/ amend. 2, 38.3

Test number	Test item	Results	Remarks
T-1	Altitude simulation	Accepted	
T-2	Thermal test	Accepted	
T-3	Vibration	Accepted	
T-4	Shock	Accepted	
T-5	External short circuit	Accepted	
T-6	Impact /Crush	Accepted	
T-7	Overcharge	Accepted	for rechargeable battery only
T-8	Forced Discharge	Accepted	for cell only

We, Jauch Quartz GmbH, hereby certify that above results are confirmed in accordance with the Manual of Tests and Criteria of the UN Recommendations on the Transport of Dangerous Goods, 5<sup>th</sup> revised edition, Amendment 2, section 38.3.

Name / Title of Signatory

Sönke Zacher / Sales Manager

Signature

Sept 11, 2015

Headquarters: Jauch Quartz GmbH · In der Lache 24 · 78056 Villingen-Schwenningen · Germany  
 Registry court: Freiburg HRB 602574, Managing Director: Thomas Jauch

As certified above the SWiFT's rechargeable, Lithium Ion battery is not subject to any shipping restriction

## 6 Operation

SWiFT is switched on and off by a quarter turn of the ring surrounding the deployment spar end cap. The turn can be in either direction

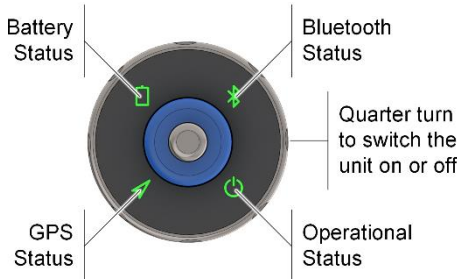

The SWiFT has an optional deployment cage that can be used to attach additional weight or afford additional protection if required.

### 6.1 Software

SWiFT and SWiFT plus can be operated with three software packages

- Valeport Ocean Software that is supplied with the instrument or can be downloaded from <http://valeport.download>.
  - Valeport Ocean is a PC program to set up, down load and display data. It is licence free.
  - Please see separate manual for further details.
- An iOS hand held device App available from the App Store
- An Android hand held device App available from the Play Store.

A SWiFT CTD must be operated with Valeport Ocean, SWiFT SVP will remain compatible with Valeport Connect even after being upgraded to the latest firmware.

If you would like to integrate SWiFT operation into your own software please contact Valeport for further information.

#### 6.1.1 Valeport Ocean Software

## 6.2 Interfacing a SWiFT

The SWiFT is designed to communicate primarily through a Bluetooth interface but has a PC cabled USB-RS232 comms capability as a fall back.

The integral Bluetooth module communicates with an iOS and Android App and can be used with Valeport's Ocean software using the supplied Bluetooth dongle. Both the dongle and the cable present a serial port to the PC with the following settings:

Baud Rate:	230400
Protocol:	8 data bits, 1 stop bit, No parity, No flow control

## 6.3 Interfacing to a PC – Valeport Ocean Software

There are two methods of connecting a SWiFT to a PC:

1. A wired connection using the supplied USB cable
2. Bluetooth with the supplied USB module.

### 6.3.1 USB Communications

The SWiFT contains a USB-Serial FTDI chip. When the SWiFT interface\charging cable is first plugged into the USB port of a PC it will install the relevant FTDI drivers.

This installation may require administration rights for the installation of the serial port drivers. If the drivers do not automatically install they can be manually installed by running the CDM v2.12.00 WHQL Certified utility.

Please note that when the USB cable is plugged into the SWiFT the GPS module is disabled and the status light is switched off.

The SWiFT will be assigned a COM port (e.g. COM10) and on every subsequent connection it should retain this port assignment. See below for interfacing example – Valeport Ocean for PC.

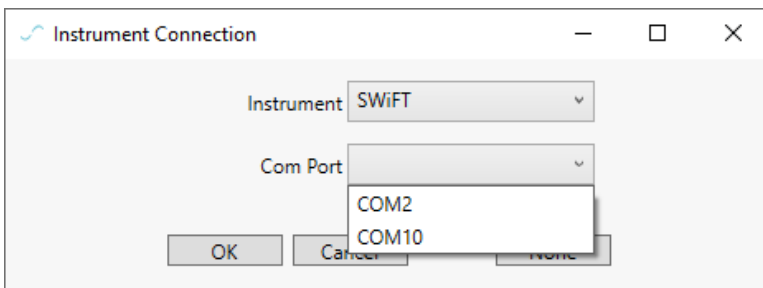

Click

### 6.3.2 Bluetooth Communications

SWiFT is fitted with an integral Bluetooth 4.0 LE chip. This allows short range wireless comms with PC or hand-held device running the Valeport Ocean software. Using the software will allow the instrument to be configured and download recorded data.

The reliable range of the Bluetooth comms is 5 to 10m. This will be reduced by obstructions between the Swift and receiver.

The SWiFT is supplied with a PC Bluetooth Module. Prior to delivery each Module is pre-paired and bound to the SWiFT that it is supplied with. The pairing can be updated using the vp\_Bluetooth application provided and available to download from the Valeport Downloads site (<http://valeport.download/>).



The SWiFT will not communicate with native Windows 10 Bluetooth or any other type of Bluetooth module other than the one supplied

If the supplied PC Module is lost or damaged, it can only be replaced – contact Valeport for further details.

The PC Bluetooth Module will install as a Serial Port Adapter and will be assigned a COM port (e.g. COM10) and on every subsequent connection it will retain this COM port designation. This installation may require administration rights for the installation of the serial port drivers, if the drivers do not automatically install they can be manually installed by running the CDM v2.12.00 WHQL certified utility contained in the Ocean installation folder on the supplied USB flash drive.

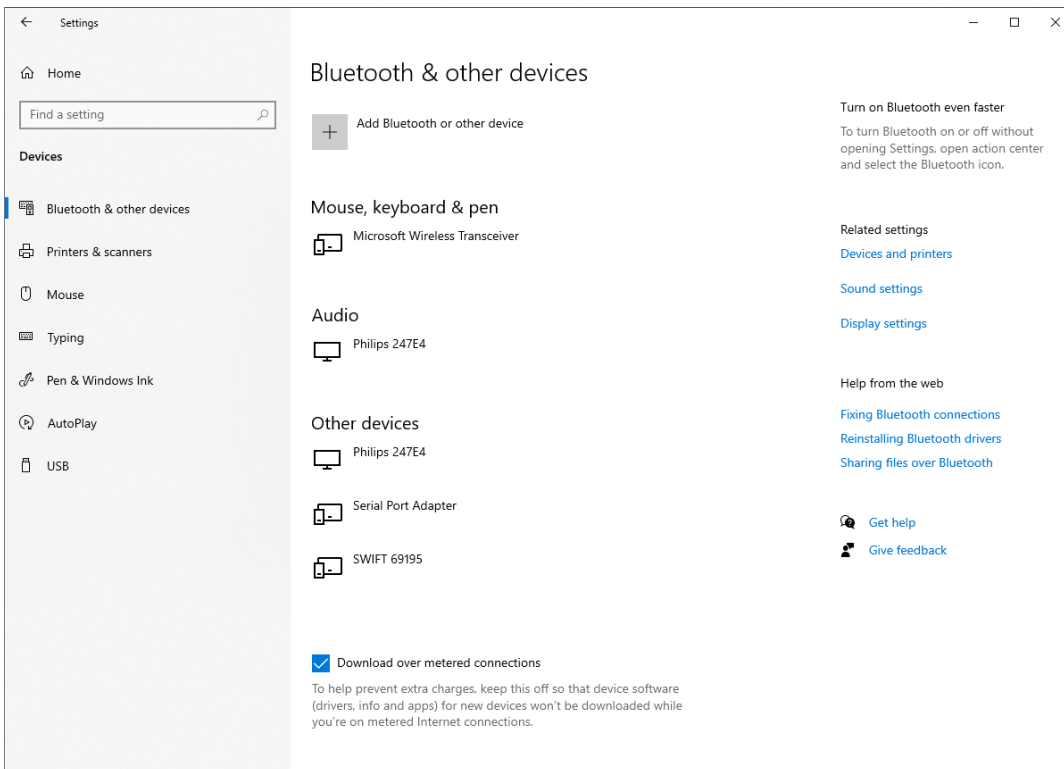

The PC Bluetooth Module is configured to automatically establish a connection to its paired SWiFT whenever it comes into range. The module scans every 10 seconds so may take up to 10 seconds to connect after the SWiFT is switched on or comes into range. The LED on the module gives an indication of operational status.

LED Status	Operation
Green	Not Connected
Purple	Scanning for paired instrument
Blue	Connected (Flashing - data transfer)
Orange	Configuration Mode
Red	Error
None	Not connected or Drivers not installed correctly

When the connection is established, the Bluetooth symbol on the SWiFT end cap will turn from green to blue. Ocean software will then be able to communicate and configure the SWiFT over Bluetooth using the configured COM port. The SWiFT can only maintain one Bluetooth connection at a time so can either talk to the mobile app OR the module.

## 6.4 Configuration

For standard operational use a SWiFT should be configured and operated through the Valeport Ocean PC, iOS or Android App. Advanced setup and operation is covered in a separate SWiFT integration guide. Contact Valeport support for more information.

See separate Valeport Ocean Software manual.

Your SWiFT Profiler will be factory paired with the Bluetooth module that it is supplied with. If you cannot communicate with your SWiFT profiler through the Bluetooth module use the Valeport Bluetooth Configurator App to re-pair the Bluetooth Module with your SWiFT. The Bluetooth Configurator App is available from <http://valeport.download>.

There are two user operational modes. Smart Profile and Continuous. The default mode for profiling operations is Smart Profile.

## 6.5 Operational Status:

The operational status LED will be solid green when the unit is switched on and not interrupted, that is, is not in a command mode.

When the unit is on but interrupted the Operational status LED will flash green.

If in an 'interrupted' state and no commands are received after 5 minutes the instrument will automatically leave the configuration status and reset to an operational mode.

If deployed in an 'interrupted' state, no profile will be recorded.

### 6.5.1 GPS Status

When the unit is switched on the GPS will immediately search for time and position data – the GPS symbol LED will flash green until a fix is acquired. Once a valid fix has been obtained the LED will switch to solid green.

If a fix is not acquired, the unit can be deployed but no position information will be recorded in the data file and the time stamp may be in error.

GPS is not operational when the comms cable is plugged in

## 6.5.2 Battery Status

As the battery becomes discharged the status LED will change from:

Green	More than 24 and up to 60 operational hours
Amber	less than 24 but more than 12 operational hours
Red	Less than 12 operational hours

If there is a fault with the battery then the LED will flash once a second in different colours.

## 6.5.3 Bluetooth Status

Green	Not Connected (in some early versions this may flash green in this mode)
Flashing Blue	Connected and Transmitting (status message will cause blue light to flash every 10s)
Solid Blue	Connected
Flashing	Low Power Mode enabled (pre September 2019)

## 6.6 Operational Modes

Use Valeport Ocean Software to configure the SWiFT and control the data download process.

See the separate Ocean Software Operating Manual.

### 6.6.1 Smart Profile Mode

A Smart Profile is the normal form of operation. An observation for each sensor – Sound Speed\Conductivity, Temperature, Pressure will be recorded at each Depth Increment as defined in the settings dialogue.

To configure the profile click on  (settings)

Select the instrument tab:



There are three controlling parameters that define an Up Cast or Down Cast:

Trigger Depth:	Trigger point at the surface (default = 1m)
Depth Increment:	The depth increment at which profile data points are recorded (default = 0.1m)
Trigger Step:	Trigger point at depth (default = 1m)

At each GPS fix a pressure reading is recorded and set as the system Tare value. The Tare pressure is recorded in the Header data of each file, it will be applied to any depth observation recorded.

Before deployment ensure you have a valid GPS fix (the GPS symbol light will be solid green) and, therefore, a Tare pressure setting to apply to the data. The SWiFT will continually update its GPS fix until deployed into the water. GPS and all LEDs are disabled at ~2m depth to conserve power.

If no GPS fix is acquired before the SWiFT is deployed, the profile data will still be recorded but with a position of 999,999.

On deployment, the following sequence will occur:

- Last GPS fix and Tare observation recorded.
- Down Cast
  - Will start recording values at programmed Trigger Depth e.g. 1.00m
  - Records data at each Depth Increment e.g. 0.10m to depth
  - Stops recording when the Trigger Step is sensed e.g. 1.00m upwards (should be set to greater than the local sea and swell)
  - Data file closed
  - Return to surface ready for new cast or download profile data.
  - Multiple casts can be recorded between downloads.
- Up Cast
  - Will start recording when the Trigger Step is sensed e.g. 1.00m upwards at the required depth (should be set to greater than the local sea and swell)
  - Records values every Depth Increment e.g. 0.10m on the up cast towards the surface
  - Stops recording when the Trigger Depth is sensed e.g. 1.00m
  - Data file close
  - Return to surface ready for new cast or download profile data.
  - Multiple casts can be recorded between downloads.
- To obtain a GPS fix, the SWiFT needs to be above the water surface and have clear visibility of open sky. A hot fix is usually obtained in less than 30 seconds. A cold fix, for example, after a long time switched off, in a new part of the world, or after a firmware update, may take a few minutes. If the sky view is restricted, obtaining a fix will take longer and the accuracy reduced.

### 6.6.1.1 Down Cast

The Trigger Depth is the depth, close to the surface, at which the Profile will start, open a new logging file and commence logging data.

The **Trigger Step** is the change in depth upwards, that will cause the Profile to stop and close the logging file. This should be set to a magnitude greater than the local sea and swell or there is a risk that the data recording may be terminated prematurely.

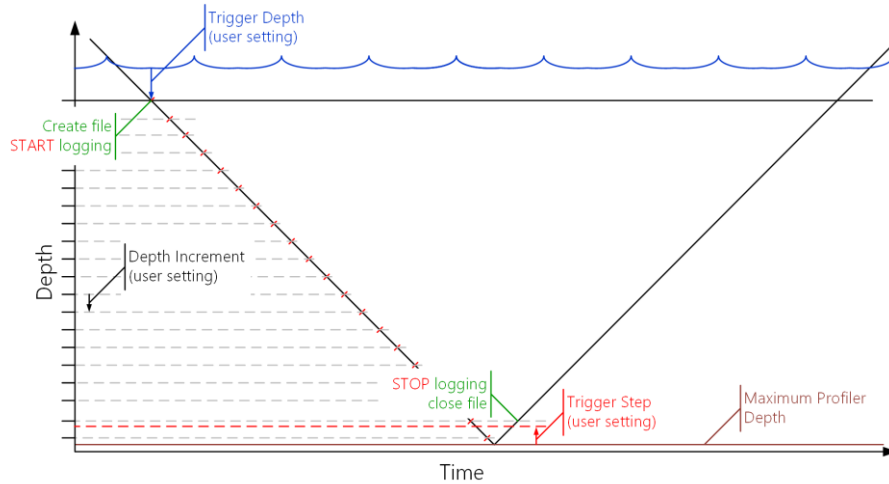

### 6.6.1.2 Up Cast

The Trigger Step is the change in depth upwards, that will cause the Profile to start and open a new logging file. This should be set to a magnitude greater than the local sea and swell or there is a risk that the data recording may be terminated prematurely.

The Trigger Depth is the depth, close to the surface, at which the Profile will stop and close the logging file.

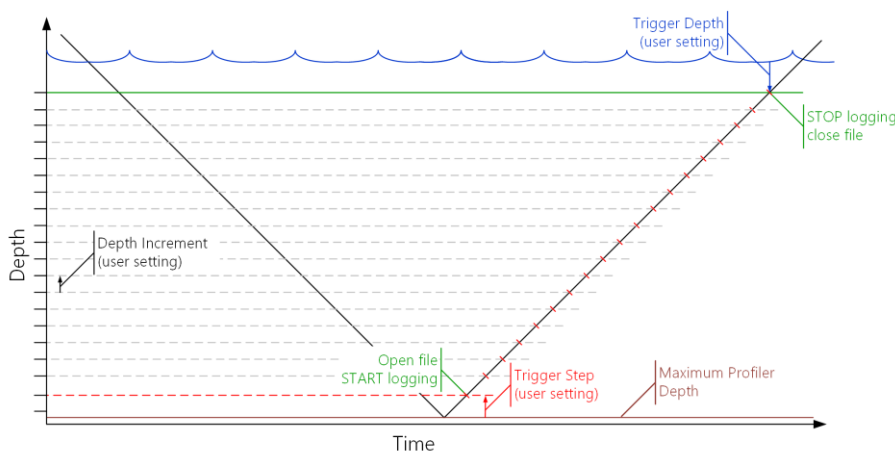

### 6.6.1.3 Auto Mode

SWiFT can be operated in an Auto Mode where on recovery Valeport Ocean will reconnect to the SWiFT and automatically download the last file recorded then return the SWiFT to a standby mode ready to be redeployed.

When configured in Smart Profile mode, and in air, the Swift will transmit a status message via Bluetooth every 10 seconds, which contains information about GPS, battery levels and the last file recorded. Monitoring this message for an update in the last file recorded allows Ocean to identify when there is a new file to download without having to interrogate the Swift.

Using the Auto Mode button  configure the operation as required:

**Download Method:** choose between Fast and Robust  
Robust transfer is ~50% slower than Fast but will attempt to recover the file download process if connection is lost between the SWiFT and Ocean.

**Select the file types and their location:** Select which file format(s) you would like the automatically down loaded file to be exported in and their destination.

**Winch Control:** SWiFT can be operated in an autonomous mode with a winch – set up as required. Please contact Valeport for further information

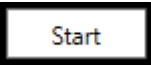
Once the required settings are programmed click . The SWiFT is now ready to deploy (check it isn't in sleep mode) and will reconnect and download the datafile on recovery. The Ocean main page changes to indicate you are in Auto Mode:



Click the  button to return to normal mode.

## 6.6.2 Continuous Mode

In Continuous mode a set of observations will be recorded at a rate of 1Hz. Data will be recorded from the moment the Instrument is set to work and will continue until the Instrument is interrupted.

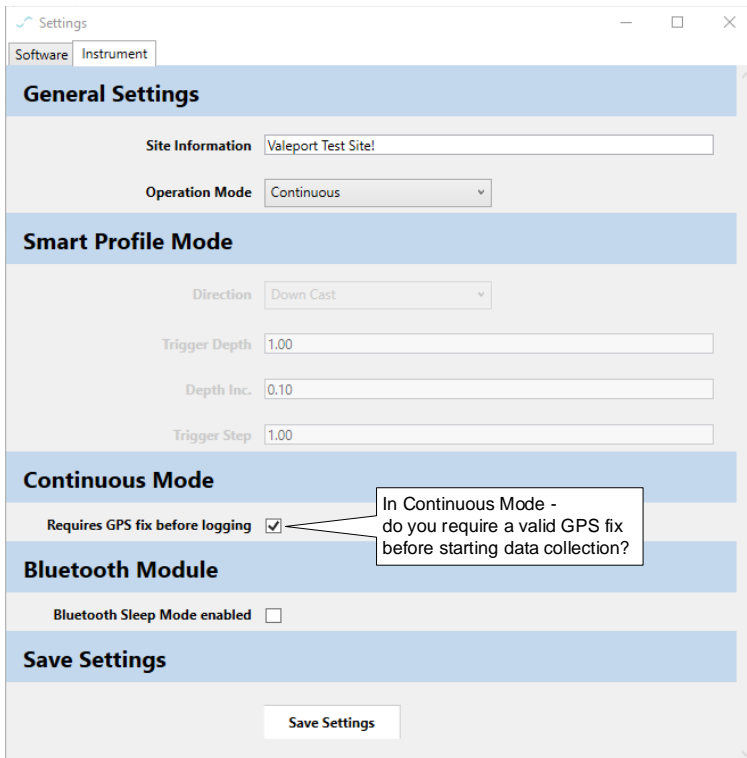

Once the unit is placed into run mode, either by turning the SWiFT on, or sending a run command: ▶.

the following criteria must be met before logging will start:

- A Valid position has been obtained **if** the 'Require GPS fix before logging' option is ticked
- or
- If the 'Require GPS fix before logging' option is not ticked as soon as the SWiFT is turned on and set to work.

Observations will be recorded at 1 Hz in continuous mode.

In a SWiFT this 1Hz recorded value is the average of a 32Hz observation period for each sensor.

Logging is stopped by turning the instrument off or Interrupting it with a # character.

## 6.7 Optical Sensor Test- SWiFT plus

In order to confirm the correct operation of the optical sensor in the SWiFT plus it is possible to conduct an in-air test.

- Open Valeport Ocean (Connect), ensure that the SWiFT is switched on and connect to it using the supplied interface cable.
- Program the SWiFT plus to operate in Continuous mode.
- Un-check the 'Require GPS fix before logging flag' unless you want to record the data (see section [Operational Modes](#)).

Now check the following:

- The LEDs on the endcap are lit (except the GPS indicator) and that light is being emitted from the optical sensor window (if operating in the visible spectrum e.g. turbidity)

Never look directly into the optical aperture

- Check that real time data is being shown on the Connect screen:

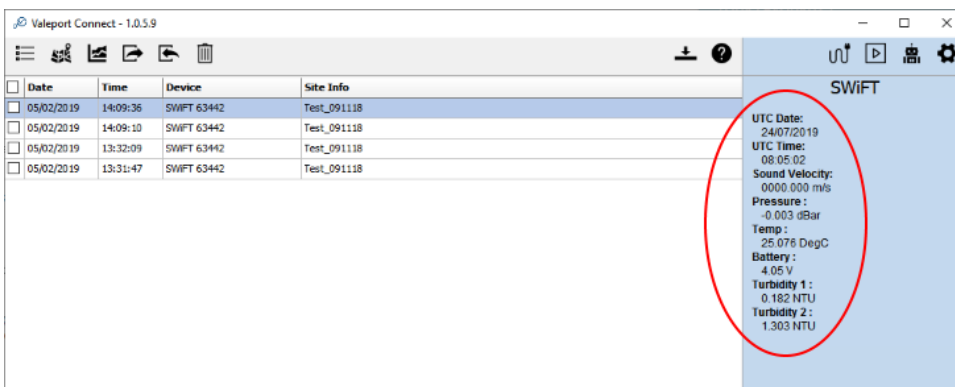

In air test with no 'target' in-front of the optical sensor

- The sound Velocity reading will be zero in air
- Pressure is atmospheric with the last Tare observation subtracted (requires a GPS fix).
- In the example above a SWiFT SVPplus Turbidity unit is shown:
  - Turbidity 1 is the Nephelometer reading
  - Turbidity 2 is the optical back scatter reading

Place the supplied target in-front of the SWiFT as shown below; in the case of the Turbidity sensor use a piece of white paper - no light is visible, look at the data in the right hand panel in Ocean.

Do not look into the optical sensor aperture.



In air test of Turbidity Sensor

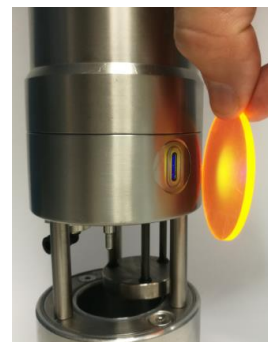

In air test of Chlorophyll a Sensor

In air test with an appropriate 'target' in-front of the optical sensor

- The magnitude of the data received increases when the supplied fluorescent target is held at 45° to the sensor window:
- By altering the angle of the target and the distance from the sensor, the magnitude of the reading should change thereby showing the correct operation of the sensor.
  - If the test target is missing then a piece of good quality white paper can be used.

## 6.8 Tare

The pressure Tare of the instrument is automatically updated and applied when a GPS fix is obtained.

The Tare value is stored, in dBar, in the VPD2 file header with a time and date stamp of when it was observed.

It is applied to the recorded pressure data.

## 6.9 Do Not Deploy Flag

In Smart Profile Mode and when the SWiFT is on the surface, a message is broadcast every 10 seconds. Within this message is a flag to indicate if the SWiFT is ready to be deployed, i.e. is a file created and is valid data going to be recorded.

There are 4 instances when the flag will be set to 0 (zero) and, therefore, the SWiFT will not be in a correct state to be deployed, it will not record data. Ocean will attempt to recover the situation using a specific reset command.

1. The GPS is off e.g. USB cable plugged in.
2. The GPS Clock is set to Year 80.
  - 2.1. Reset the GPS, make sure you have a recent and valid GPS fix. A clear view of the sky will be required.
3. Date from GPS is NOT greater than 1/1/2018.
  - 3.1. Reset the GPS, make sure you have a recent and valid GPS fix. A clear view of the sky will be required.
4. Pressure reading is greater than the Trigger Point. If there is a small Tare value taken from a normal atmospheric value or Tare mode is turned off.
  - 4.1. Turn the SWiFT off and back on again, ensure you have a valid GPS fix. This will cause a new file to be created and a Tare value recorded.

When the Flag is set to 0 a warning message is shown in Ocean.

The most usual reason for this error status is an incorrect GPS update. Try moving the SWiFT to an area of open sky and ensure a valid GPS fix has been received. Switch off and back on again and monitor the flag.

## 6.10

### 6.10 Status Message

The SWiFT continuously broadcasts a status message over Bluetooth when on the surface.

It allows for the status of the SWiFT to be determined without interrupting its operation.

The message is broadcast every 10 seconds and is in the form of a proprietary NMEA type message. It contains the following information:

```
$PVBB,00102532,56150,50.4264,-3.6814,66.00,210118154647,0,*42
$PVBB,00102532,56150,50.4264,-3.6814,65.99,210118154647,0,*41
$PVBB,00102532,56150,50.4264,-3.6814,65.99,210118154647,0,*41
$PVBB,00102532,56150,50.4264,-3.6814,65.98,210118154647,0,*40
```

Where:

\$PVBB	Type	Identifier
00102532	Identifier	Hardware ID
56150	Long	Instrument Serial Number
50.4264	Float	Last Latitude (Decimal Degrees), 999 for no fix
-3.6814	Float	Last Longitude (Decimal Degrees), 999 for no fix
66.86	Float	Battery Status (hours remaining until empty)
210118154647	Time	Date/Time Stamp of last recorded file [YYMMDDhhmmss]
0 or 1	Char	Ready for deployment (New file flag and in run mode)
*40		Check Sum

### 6.11 Data File

If a file has already been extracted and converted from the binary format using the iOS app or Ocean, it will be stored in a VP2 format. This is a common format that is used across many recent Valeport products.

From Connect version 1.0.4.0 and Valeport Ocean a slightly altered format: VP2 was introduced to replace VPD and allow for future expansion. The structure is largely the same.

This format is generated from Connect | Ocean and the iOS App after download and during recording. The raw downloaded and recorded files are also maintained as a backup.

#### 6.11.1 Basic Structure:

The basic structure is that of an INI file:

The file is split into sections (denoted by a the name of the section in square [ ] brackets).

Within each section, the values are presented as Key Value pairs, delimited by an 'equals' sign.

INI files are fairly old technology, but have been chosen for a number of reasons:

- a. They are readily readable as text files.
- b. They can be randomly accessed for both read and write - many programming languages have readily available INI File Access Classes.
- c. They are not case sensitive.
- d. Their structure can be split into sections, and the sections can be hierarchical by using a back-slash '\'
- e. Comments can be added (prefixing the line with a semicolon ';')
- f. They can be readily dropped into Excel etc for onward processing.

More information on Windows INI Files can be found here: [http://en.wikipedia.org/wiki/ini\\_file](http://en.wikipedia.org/wiki/ini_file)

## 6.12 Data File Translation

Once downloaded from the SWiFT, profiles can be exported from Ocean to the following Industry Standard formats.

The following profile formats are available in the iOS and Android App:

Valeport File (default)	.vp2 format
AML	.csv format
CARIS	.svp format
ELAC	.sva format
Hypack	.vel format
Kongsberg	.asvp format
Reson Simplified Profile	.svp format
Reson Velocity Profile	.log format
Sonardyne Pro	.pro format
Sonardyne SPI	.ssp format

If the format you require is not available then contact [support@valeport.co.uk](mailto:support@valeport.co.uk)

## 6.13 Real Time Data Format

When operating in continuous mode and connected by cable or Bluetooth the SWiFT will output the following data format:

### Example: \$PVS2 – SWiFT SVP plus

\$PVS2,20170407,110107,0000.008,m/s,-9.059,dBar,1.000,DegC,optics1,unit,optics2,units,3.88,V,682\*1B

Where:

\$PVS2	Name	Units	Format
20200521	Date		YYYYMMDD
150715	Time		hhmmss
1500.000	Sound Velocity	m/s	xxxx.xxx
m/s	Units		m/s
10.310	Pressure	dBar	x.xxx
dBar	Units		dBar
23.870	Temperature	Degrees C	x.xxx
DegC	Units		DegC
*	optics1		x.xxx
*	Units	parameter dependent	xxx
*	optics2		x.xxx
*	Units	parameter dependent	xxx
3.88	Volts	Volts	x.xx
9	Units		V
3863	Log index	32Hz ticks	xxxxxx
*6A	Checksum		*xx

\* Blank if not relevant but field maintained



**Example: \$PVCT2 – all SWiFT CTDs**

\$PVCT2,20200728,141318,0000.725,mS/cm,10.228,dBar,0.019,DegC,0.236,ug/l,,,4.08,V,352\*04  
Where:

\$PVCT2	Name	Units	Format
20200728	Date		YYYYMMDD
141318	Time		hhmmss
0000.000	Conductivity	mS/cm	xxxx.xxx
mS/cm	Units		mS/cm
10.228	Pressure	dBar	x.xxx
dBar	Units		dBar
23.870	Temperature	Degrees C	x.xxx
DegC	Units		DegC
0.236	optics1		x.xxx
ug/l	Units	parameter dependent	xxx
*	optics2		x.xxx
*	Units	parameter dependent	xxx
4.08	Volts	Volts	x.xx
V	Units		V
352	Log index	32Hz ticks	xxxxx
*04	Checksum		*xx

\* Blank if not relevant but field maintained

## 7 Power Saving Modes

### 7.1 Auto Power Saving Mode:

A mode has been implemented to save power if the SWiFT is inadvertently left switched on.

When operating in Smart Profile mode, if no activity is detected after a defined period, the SWiFT will turn itself off. As a factory default this is set to 120 mins. This value can be changed with a configuration code or disabled, see below.

If the SWiFT has automatically turned it off, all the status lights will be off and the switch ring will need to be rotated two quarter turns to wake it up.

When operating in Continuous Mode, if the SWiFT is left on, it will continue to operate until the battery is empty and then switch off.

#### 7.1.1 Manual setting of Auto Power Mode

Using a terminal program such as Valeport's Terminal, establish a connection with the SWiFT and send a # character to interrupt the instrument.

Now send:

#016

to view the present setting

If you need to change the time, in minutes, before Auto Power Saving is enabled send:

#015;x

Where x is the number of minutes the SWiFT will experience no activity before it enters Auto Power Saving Mode

#015;9999 will turn Auto Power Mode off.

Check that the update was successful - #016 and then place back into a run mode - #028

Example of manual Auto Power Mode command sequence, changing the time out from 120 minutes to 60 minutes:

```

Valeport Terminal X2 [Untitled]
Port: COM5
Baud: 230400,N,8,1

Port: COM5:230400,N,8,1 Connected
$PVBB,00101230,46104,50.4063,-3.7521,54.23,210118183200,1,*37#
$PVBB,00101230,46104,50.4063,-3.7521,54.23,210118183200,1,*37#
$PVBB,00101230,46104,50.4063,-3.7521,54.22,210118183200,1,*36#
#
ERROR#
>#016#
120;#
>#015;60#
>#016#
60;#
>#028#
>#PVBB,00101230,46104,50.4063,-3.7522,54.21,210118183200,1,*36#
$PVBB,00101230,46104,50.4063,-3.7522,54.20,210118183200,1,*37#

Command: #028
Received: 368 Bytes 14 Lines
12:30:11

```

## 7.2 Bluetooth Sleep Mode in Valeport Ocean

Primarily designed for use on long duration autonomous vessels, a Bluetooth Sleep Mode has been developed for SWiFT to provide maximum endurance.

A Bluetooth Sleep Mode was made available in SWiFTs delivered after May 2018. If your SWiFT is enabled to operate in this mode the Bluetooth LED will flash at 1 Hz, while in this mode. If in range, the LED on the paired PC Bluetooth Module will show as connected.

From September 2019 Bluetooth Sleep Mode changed when a new SWiFT Bluetooth Module was fitted to new instruments. If your SWiFT is enabled to operate in Bluetooth Sleep Mode all the LEDs will be switched off, while in this mode. If in range, the LED on the PC Bluetooth Module will show as connected.

When in Bluetooth Sleep Mode, the timeout for auto power down is still enabled but the SWiFT can be woken up by sending a character over the Bluetooth link, this can be done by clicking the ‘run’ button  in Ocean, or manually in a terminal package. The SWiFT can also be woken from Bluetooth Sleep Mode by rotating the switch ring by two quarter turns.

From the release of Valeport Ocean, control of Bluetooth Sleep Mode from the application interface was introduced.

To enable the mode, Select Bluetooth Sleep mode in the Settings option:

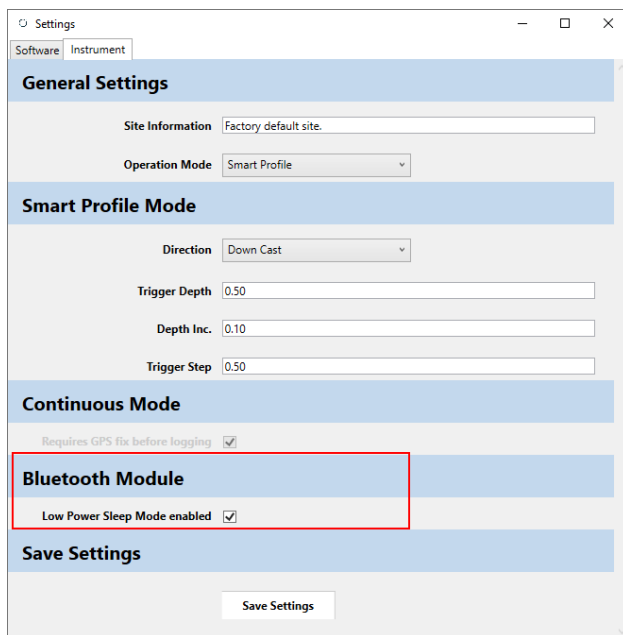

The Sleep Mode icon, in the top right-hand corner of the operational screen, will change from greyed out to solid black, click it to set the SWiFT into Sleep mode: .

The following message is displayed if the SWiFT is successfully placed into Sleep Mode:

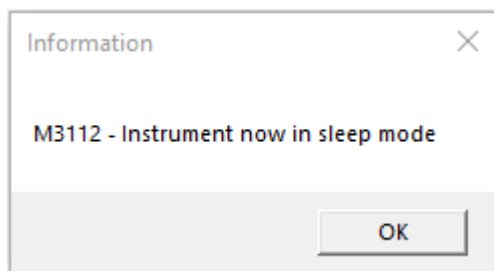

In this mode all sensors are disabled and the SWiFT will appear to be off. If in range, the LED on the PC Bluetooth Module will show as connected (solid blue).

Clicking the 'run'  icon to wake the SWiFT, the LEDs on the SWiFT will activate and within 10 seconds a status message will be transmitted from the SWiFT and then updated every 10 seconds.

If you deploy the SWiFT while in sleep mode – no profile will be recorded

## 7.2.1 Bluetooth Sleep Mode Detail – Manual Operation (Post September 2019)

Enable Low Power Mode:

#160;1 Enable Low Power sleep mode  
#160;0 Disable Low power sleep mode  
#161 Read Low power sleep mode

### 7.2.1.1 To Place a SWiFT into Low Power Sleep Mode:

#162 Will return an error if Low Power Sleep mode is disabled.

Issue the serial command (#162) to the SWiFT. This powers down the main processes leaving only the Bluetooth connection running.

All lights will turn off. In this mode the SWiFT will draw ~2.6mA.

### 7.2.1.2 To Wake a Swift from Low Power Sleep Mode:

Send any character. Do not use # as this will interrupt the instrument. If the instrument is interrupted, it will need a #028 command to set into run mode.

If the SWiFT has been successfully woken up, within 10 seconds a status message will be transmitted from the SWiFT and then updated every 10 seconds.

See section on the [Status Message](#) for details of this message.

## 7.2.2 Low Power Mode Detail - Pre September 2019

If you have an older SWiFT – pre-September 2019 and require to operate in a low power mode, please contact Valeport to discuss upgrading your instrument.

## 8 Care and Maintenance

SWiFT is a robust profiling sensor and will provide many years of reliable service.

The unit should be thoroughly cleaned and rinsed with fresh water before being returned to its transit case, where it should be kept at all times when not in use.

Care should be taken when removing and replacing the deployment spar to gain access to the charging and data port. The O rings included in the locking mechanism are an integral part of the system to keep the SWiFT watertight and should be kept in good condition and checked for correct seating before reassembly.

When the deployment spar is removed every care should be taken to avoid any water getting into the connector bay. If water does inadvertently make its way into this space it should be very carefully dried out. The deployment spar should not be put back in place until the connector bay is completely dry as water could be forced further into the instrument and cause damage to the connector or even the electronics inside the housing.

Charging should not be carried out where any water is present.

### 8.1.1 Long Term Storage

When a SWiFT is to be stored for an extended period it should be

- Cleaned thoroughly in freshwater
- rings cleaned and greased, checked for wear and damage, ideally replaced
- The battery should be fully charged. This will not damage the battery or increase the risk of venting. It will, however, prevent the battery from becoming fully discharged that can cause significant problems for the battery when it is recharged.
- Returned to its clean and dry transit case.

## 9 Upgrading Your SWiFT

### 9.1 Valeport SWiFT - Firmware Upgrade

This procedure describes the upgrade process for the firmware of a SWiFT.

This upgrade is required to operate with the new Valeport Connect PC and Connect iOS applications.

It is compatible with all SWiFT CTD profilers.

#### Requirements

- Windows PC
- Valeport's Bootloader Utility (ver.1.0.10.3 or higher)
- SWiFT firmware .zip file
- SWiFT to be upgraded
- USB interface cable

Once upgraded to 0650735, the SWiFT and SWiFTplus will NOT be compatible with:

- Valeport DataLog x2 - replaced with Valeport Ocean for PC
- Valeport SWiFT iOS App - replaced with Valeport Ocean App for iOS  
- and potentially other third-party software integrations.

Please contact Valeport for further details

#### 9.1.1 Step 1 - Download the Required Files

Visit Valeport's dedicated Downloads site: <http://valeport.download/>

Select SWiFT from the drop-down menu

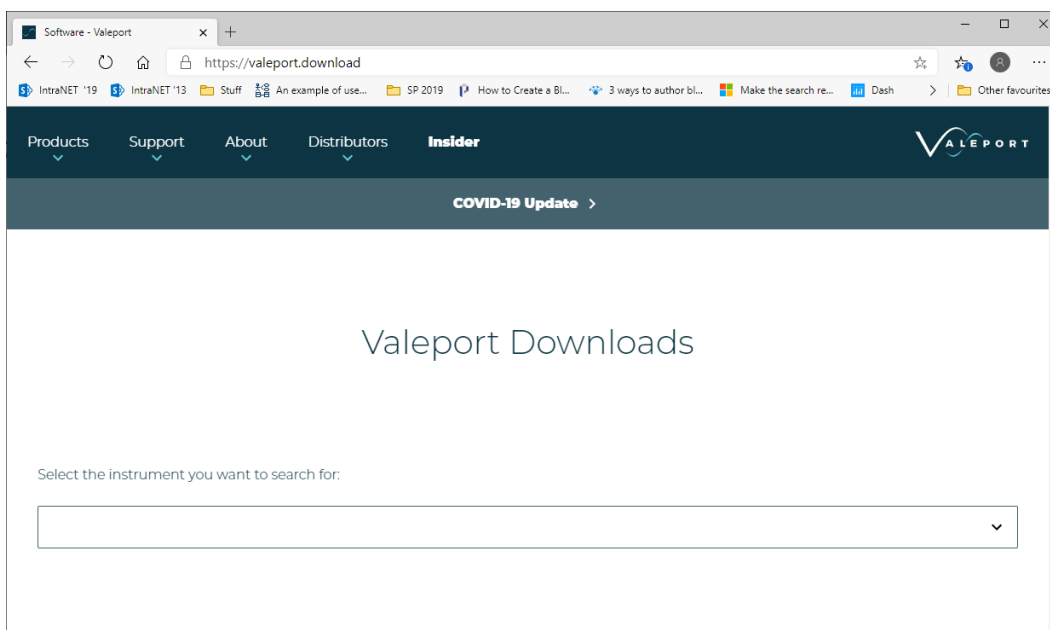

- Download the following files:
- Bluetooth Configurator
- Valeport Ocean
- Bootloader Utility
- SWiFT Firmware - **do not unzip this file**

+

ps://valeport.download

Stuff An example of use... SP 2019 How to Create a Bl... 3 ways to author bl... Make the search re... Dash www.valeport Free Online Mannin...

Windows Software				
Product	Description	Suitable for:	Version	Get
Connect <i>Recommended</i>	<p>Valeport Connect, developed for Valeport's Bluetooth equipped profilers, replaces DataLog X2 for SWiFT, SWiFTplus and rapidPro profilers.</p> <p>Notes:</p> <ul style="list-style-type: none"> <li>+Presently available for windows 10 PC and Apple iOS</li> <li>+Bluetooth line of site ranges are:                             <ul style="list-style-type: none"> <li>- LE \ Classic: approximately 10m</li> <li>- with an external antenna: approximately 30 to 40m</li> </ul> </li> </ul> <p>Use of an antenna will allow the autonomous operation of an instrument on back deck with the controlling PC inside e.g. operation with a winch</p> <p>Functionality:</p> <ul style="list-style-type: none"> <li>+ Instrument set up and set to work</li> <li>+ Auto Bluetooth reconnect from the instrument and last file download</li> <li>+ Alpha numeric and graphical display including geo-location on Open Street Maps</li> <li>+ Industry standard data formats export - email and cloud services</li> </ul> <p>What's new?</p> <p>Enhancement for RapidPRO CTD Turbidity</p>	+ All rapidPro variants + All SWiFT variants	1.0.7.10	 
Bluetooth Configurator	<p>Bluetooth Configurator is used to reprogram a bluetooth dongle and pair it with a Valeport instrument</p> <p>What's new?</p> <ul style="list-style-type: none"> <li>- Enhanced version to include rapidPro</li> <li>- Minor bug fixes</li> </ul>	+ All SWiFT variants	1.1.2.1	 
SWiFT Bootloader	<p>SWiFT BootLoader will allow you to factory reset your SWiFT instrument</p> <p>What's new?</p>	+ All SWiFT variants	1.0.10.5	

### 9.1.2 Step 2 - Update the Firmware

1. Unplug any devices interfaced to any serial ports on the PC
2. Install SWiFT Bootloader (vpSWiFTBootLoaderSetup.exe)
3. Interface the SWiFT to the PC with the provided USB lead
4. Ensure the SWiFT is powered on

If you are operating a laptop on battery power, ensure you have sufficient power to complete the operation

Run the Bootloader utility:

- The correct device should be shown in the top input box
- When the device is selected, the battery status of the device and current firmware should be displayed
- Drag and drop the firmware.zip file onto the application
  - Or use the browse button in the lower input box and navigate to the location of the firmware.zip file and select it:

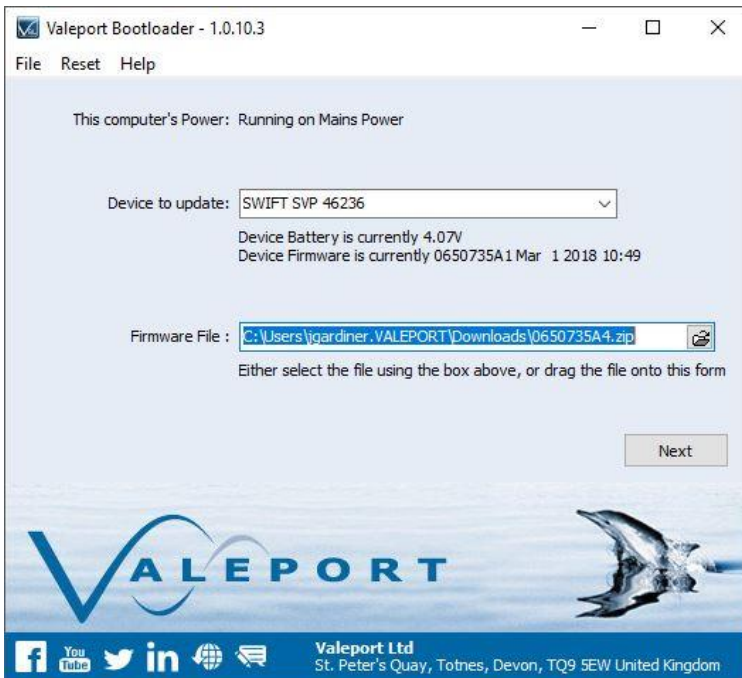

Click 

A summary of which device will be programmed with which firmware will be displayed. Check carefully you are programming the correct device with the correct firmware:

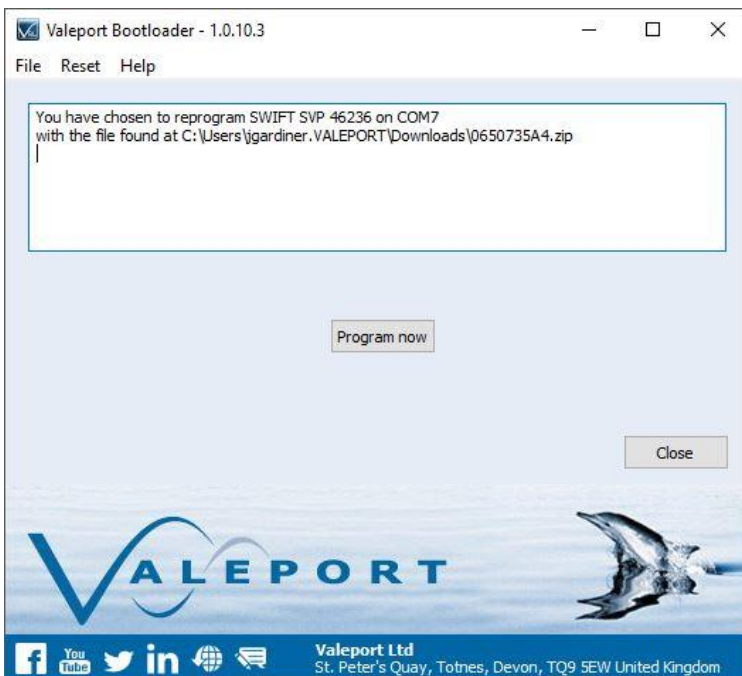

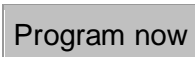
Once you are satisfied everything is correct, click 

The status of the firmware update will be displayed. The LED's on the SWiFT will flash and may go off completely at times.



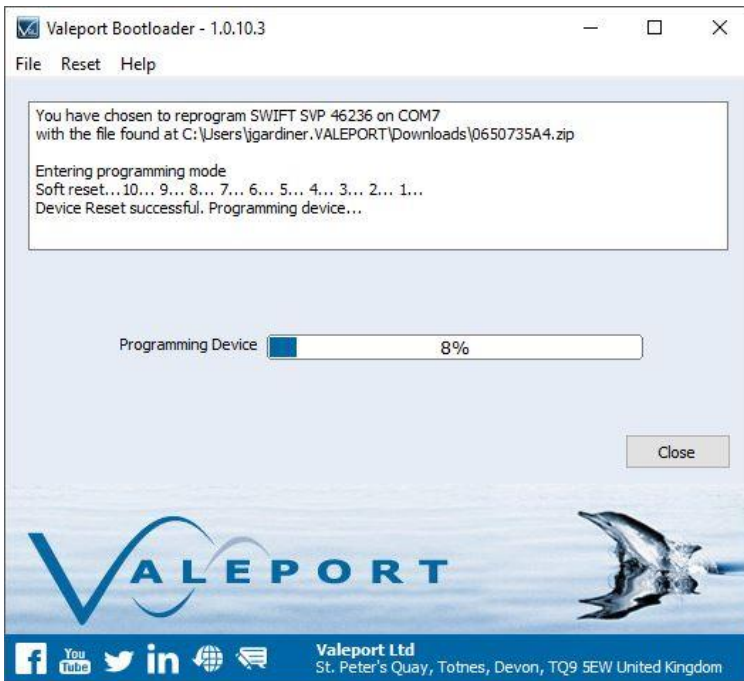

Do not interrupt this process

You should see an 'update successful' message when the process is complete:

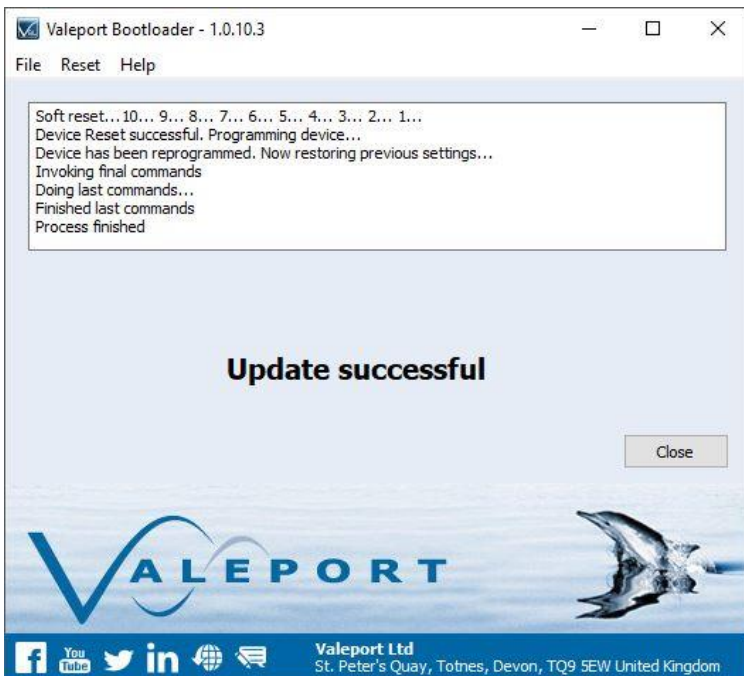

After updating your firmware, it is very important that you insure a valid GPS fix is received by the unit before it is deployed. The system must have valid clock and date settings in order to open logging files correctly

If the firmware update fails, contact Valeport for support:

e mail: [support@valeport.co.uk](mailto:support@valeport.co.uk)

Tel: +44(0)1803 869292 (UK office hours only)

## 9.2 Bluetooth Adapter - Re-Program and Pair

Complete the following steps:

1. Install the Bluetooth Configurator utility (vpBluetoothSetup.exe)
2. Ensure that the SWiFT USB cable is disconnected
3. Ensure the SWiFT is turned on
4. Plug USB Bluetooth adapter into the PC and note the Com port number
5. Select the Com port the USB Bluetooth adapter is configured as

In order to do this go to the Windows Control Panel > Device Manager > Ports (COM & LPT) if the Com port is not obvious, unplug the cable or Bluetooth adapter, the Com will disappear and reappear when the adapter is plugged back in.

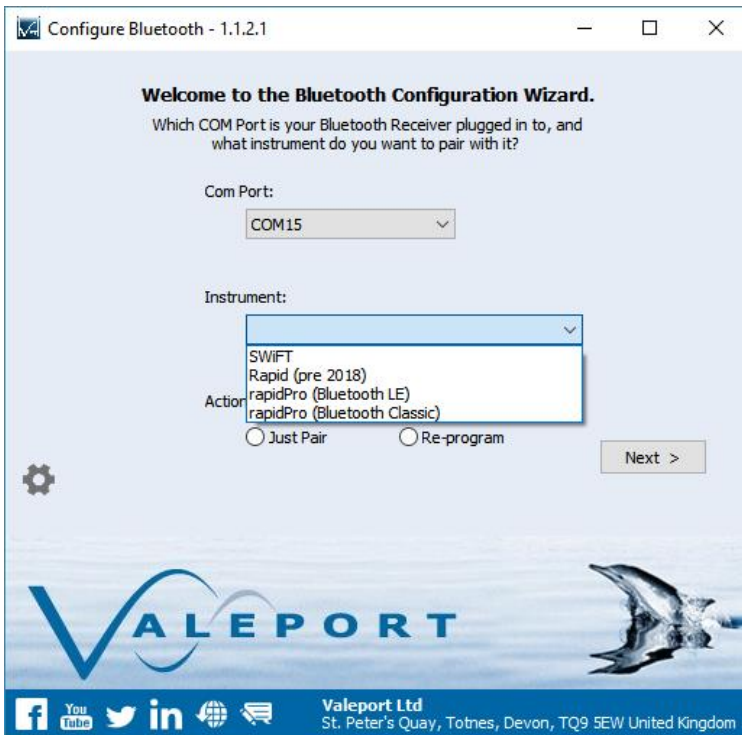

- Select the instrument type:
  - SWiFT: SWiFT SVP & CTD and SWiFT SVPplus & CTDplus
  - Rapid: original Rapid, pre 2018
  - Rapid Logger (Bluetooth LE Mode): ProLogger Module (rapidPro SVT, CTD and CTDplus) - Factory Default.
  - Rapid Logger (Classic Mode): ProLogger Module (rapidPro SVT, CTD and CTDplus).
- Select **Re-program** if your Bluetooth module is not in the mode required - Classic or LE.
- Select **Just Pair** if your Bluetooth module is in the correct mode and you simply need to pair with your instrument.

Click 

The status LED on the USB Bluetooth module will change colour a number of times while it is being configured

Once configured, the USB Bluetooth key will scan for devices in range.

Your Instrument should appear in the list, if it doesn't, ensure it is powered up, in range and not connected to another adapter or Bluetooth device and try again:

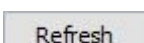
Click  on

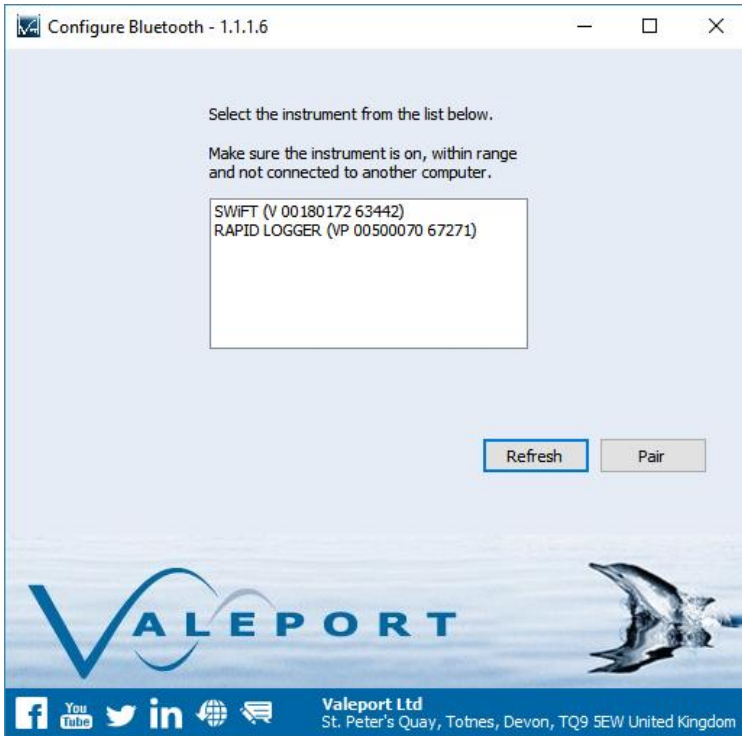

Select your Instrument from the list and

Click 

The LED on the adapter should go blue to indicate a successful pairing operation. If your Instrument has a visible Bluetooth LED it should also have turned blue.

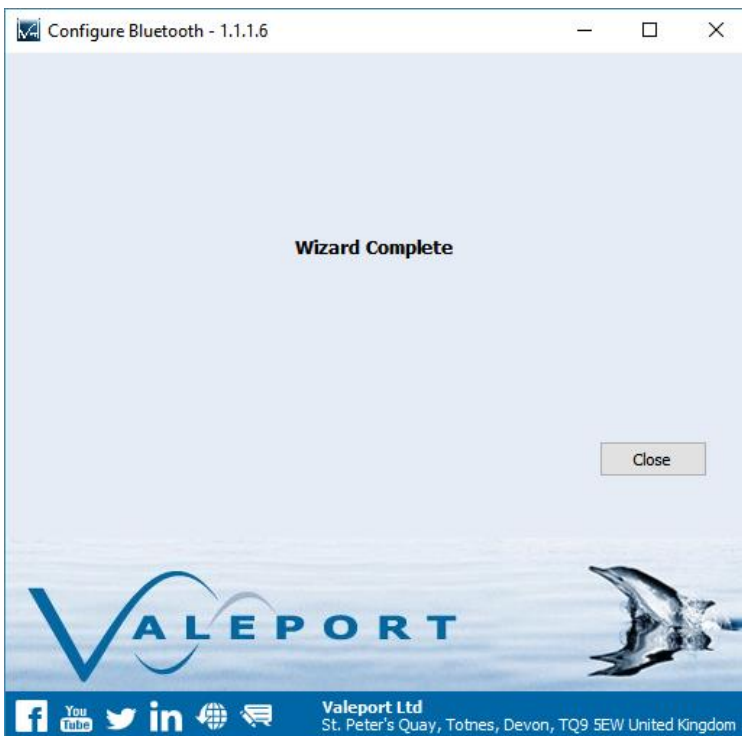

## 10 Ordering and Part Numbers

### 10.1 SWiFT SVP

Part No.	DESCRIPTION
	Basic Instruments
0660047 - 50	<p>SWiFT SVP Profiler - Titanium housing rated to 500m (from September 2019)</p> <p>Fitted with</p> <ul style="list-style-type: none"> <li>• 35mm Carbon composite time of flight SV sensor</li> <li>• Pressure sensor - 0.01% FS</li> <li>• PRT Temperature Sensor</li> <li>• Bluetooth connectivity and GPS module</li> <li>• Rechargeable battery pack</li> <li>• LED status indication</li> </ul> <p>Supplied with:</p> <ul style="list-style-type: none"> <li>- Deployment weight</li> <li>- USB Interface and Charging cable</li> <li>- PC USB Bluetooth adapter</li> <li>- Multi-zone Charger</li> <li>- Valeport Ocean Software</li> <li>- iOS and Android Apps available to download</li> <li>- System transit case</li> </ul>
0660047-50-YY	<p>SWiFT SVPplus Profiler - Titanium housing rated to 500m (from September 2019)</p> <p>Fitted with</p> <ul style="list-style-type: none"> <li>• Optical Sensor</li> <li>• 35mm Carbon composite time of flight SV sensor</li> <li>• Pressure sensor - 0.01% FS</li> <li>• PRT Temperature Sensor</li> <li>• Bluetooth connectivity and GPS module</li> <li>• Rechargeable battery pack</li> <li>• LED status indication</li> </ul> <p>Supplied with:</p> <ul style="list-style-type: none"> <li>- Deployment weight</li> <li>- USB Interface and Charging cable</li> <li>- PC USB Bluetooth adapter</li> <li>- Multi-zone Charger</li> <li>- Valeport Ocean Software</li> <li>- iOS and Android Apps available to download</li> <li>- System transit case</li> </ul> <p>YY denotes the optical sensor:</p> <p>Ch: Chlorophyll a                      FI: Fluorescein                      Rh: Rhodamine                      SRB: Sulforhodamine B                      PC: Phycocyanin                      Tu: Turbidity</p>

## 10.2 SWiFT CTD

Part No.	DESCRIPTION
	Basic Instruments
0660049 - 50	<p>SWiFT CTD Profiler - Titanium housing rated to 500m Fitted with</p> <ul style="list-style-type: none"> <li>• Inductive Conductivity sensor</li> <li>• 50 bar Pressure sensor - 0.01% FS</li> <li>• Thermistor Temperature Sensor</li> <li>• Bluetooth connectivity and GPS module</li> <li>• Rechargeable battery pack</li> <li>• LED status indication</li> </ul> <p>Supplied with:</p> <ul style="list-style-type: none"> <li>- Deployment weight</li> <li>- USB Interface and Charging cable</li> <li>- PC USB Bluetooth adapter</li> <li>- Multi-zone Charger</li> <li>- Valeport Ocean Software</li> <li>- iOS and Android Apps available to download</li> <li>- System transit case</li> </ul>
06604187	SWiFT CTD Cage

## 11 Declarations of Conformity

Any changes or modifications to the product or accessories supplied, that are not authorised by Valeport Ltd, could void the CE compliance of the product and negate your authority to operate it. This product has demonstrated CE compliance under conditions that include the use of shielded cables. It is important that you use shielded cables compliant with the product's conformance, to protect from potential damage and reduce the possibility of interference to other electronic devices

## 11.1 SWiFT and SWiFT plus

### 11.1.1 EU Declaration of Conformity



## EU Declaration of Conformity

<b>Manufacturer:</b>	Valeport Ltd
<b>Address:</b>	St Peter's Quay, Totnes, Devon, TQ9 5EW
<b>Certification marking:</b>	CE
<b>Product Description:</b>	SWiFT CTD   SWiFT CTDplus SWiFT SVP   SWiFT SVPplus

We the manufacturer declare that the product **SWiFT CTD, SWiFT CTDplus, SWiFT SVP, SWiFT SVPplus** is in conformity with the following EU Directives and harmonised standard(s):

Radio Equipment Directive 2014/53/EU	Standards
Safety (Article 3.1a)	EN 61010-1:2010+A1:2019 EN 62479:2010 EN 60950-1:2006+A2:2013
EMC (Article 3.1b)	EN 301 489-1 V2.1.1 (Basic Level) EN 301 489-17 V3.1.1 EN 60945:2002 EN 61326-1:2013 (Basic Level)
Radio Spectrum (Article 3.2)	BS EN 300 328 V2.1.1 BS EN 300 330 V2.1.1 BS EN 303 413 V1.1.1

RoHS Directive 2015/863/EU	Standards
Prevention (Article 4.1)	BS EN IEC 63000:2018

Additional harmonised standard for **SWiFT CTDplus, SWiFT SVPplus** profilers with optical sensor fitted:

Harmonised Safety Standards	Standards
Photobiological safety of lamps and lamp systems	BS EN 62471:2008

<b>Name:</b>	Surya Dinesh
<b>Position:</b>	Product Support Manager
<b>Place of issue:</b>	Valeport Ltd, Totnes, UK
<b>Date of issue:</b>	29 September 2020
<b>Signature:</b>	

Valeport Limited  
St. Peter's Quay, Totnes,  
Devon TQ9 5EW UK

+44 (0) 1803 869292  
sales@valeport.co.uk  
www.valeport.co.uk

VAT No: GB 165 8753 67  
Registered in England No. 1950444



### 11.1.2 UK Declaration of Conformity



## UK Declaration of Conformity

<b>Manufacturer:</b>	Valeport Ltd
<b>Address:</b>	St Peter's Quay, Totnes, Devon, TQ9 5EW
<b>Certification marking:</b>	UKCA
<b>Product Description:</b>	SWiFT CTD   SWiFT CTDplus SWiFT SVP   SWiFT SVPplus

We the manufacturer declare that the products:  
SWiFT CTD, SWiFT CTDplus, SWiFT SVP and SWiFT SVPplus are in conformity  
with the following UK Statutory requirements and designated standard(s):

Radio Equipment Regulations 2017	Standards
Safety (SI 2016 No.1101)	BS EN 61010-1:2010 BS EN 62479:2010 BS EN 60950-1:2006+A2:2013
EMC (SI 2016 No.1091)	BS EN 301 489-1 V2.1.1 (Basic Level) BS EN 301 489-17 V3.1.1 BS EN 60945:2002 BS EN 61326-1:2013 (Basic Level)
Radio Spectrum (SI 2017 No. 1206)	BS EN 300 328 V2.1.1 BS EN 300 330 V2.1.1 BS EN 303 413 V1.1.1

ROHS Regulations 2012	Standards
SI 2012 No. 3032	BS EN IEC 63000:2018

Additional designated standard for SWiFT CTDplus, SWiFT SVPplus profilers with optical sensor fitted:

Designated Safety Standards	Standards
Photobiological safety of lamps and lamp systems	BS EN 62471:2008

<b>Name:</b>	Surya Dinesh
<b>Position:</b>	Product Support Manager
<b>Place of issue:</b>	Valeport Ltd, Totnes, UK
<b>Date of issue:</b>	14 January 2020
<b>Signature:</b>	

Valeport Limited  
St. Peter's Quay, Totnes,  
Devon TQ9 5EW UK

+44 (0) 1803 869292  
sales@valeport.co.uk  
www.valeport.co.uk

VAT No. GB 165 8753 67  
Registered in England No: 1950444







### Approved antenna

Antenna name	Manufacturer	Comment	Gain
Internal Bluetooth antenna	ProAnt	SMD PIFA antenna	+2dBi
Internal A15-4840920-UBL9	AMOTECH	1571MHz - 1606MHz	

**Valeport Limited**  
St. Peter's Quay, Totnes,  
Devon TQ9 5EW UK

+44 (0) 1803 869292  
sales@valeport.co.uk  
www.valeport.co.uk

VAT No GB 955 6755 07  
Registered in England No 1060544



## 11.2 SWiFT Bluetooth Module - Qualifications and Approvals

SWiFT Profilers (from September 2019) have u-blox type NINA B112 stand-alone Bluetooth® module fitted as standard.

It complies with the essential requirements and other relevant provisions of Radio Equipment Directive (RED) 2014/53/EU and Restriction of Hazardous Substances (RoHS) Directive 2011/65/E.

### 11.2.1 European Union Regulatory Compliance

Information about European Union regulatory compliance for the NINA-B1 series modules is available in the NINA-B1 Declaration of Conformity.

### 11.2.2 Safety Compliance

In order to fulfil the safety standard EN 60950-1, the NINA-B1 series modules must be supplied with a Class-2 Limited Power Source.

### 11.2.3 FCC and IC Compliance

#### 11.2.3.1 IC compliance

This device complies with Industry Canada license-exempt RSS standard(s). Operation is subject to the following two conditions:

1. This device may not cause interference, and
2. This device must accept any interference, including interference that may cause undesired operation of the device.

Under Industry Canada regulations, this radio transmitter may only operate using an antenna of a type and maximum (or lesser) gain approved for the transmitter by Industry Canada. To reduce potential radio interference to other users, the antenna type and its gain should be chosen in such a way that the equivalent isotropically radiated power (e.i.r.p.) is not more than that is necessary for successful communication.

This equipment complies with IC RSS-102 radiation exposure limits set forth for an uncontrolled environment. This equipment should be installed and operated with a minimum distance of 20 cm between the radiator and your body.

### 11.2.4 FCC Statement

This device complies with Part 15 of the FCC Rules. Operation is subject to the following two conditions:

1. This device may not cause harmful interference, and
2. This device must accept any interference received, including interference that may cause undesired operation.

This equipment has been tested and found to comply with the limits for a Class B digital device, pursuant to Part 15 of the FCC Rules. These limits are designed to provide reasonable protection against harmful interference in a residential installation. This equipment generates, uses and can radiate radio frequency energy and, if not installed and used in accordance with the instructions, may cause harmful interference to radio communications. However, there is no guarantee that the interference will not occur in a particular installation. If this equipment does cause harmful interference to radio or television reception, which can be determined by turning the equipment off and on, the user is encouraged to try to correct the interference by one or more of the following measures:

- Reorient or relocate the receiving antenna
- Increase the separation between the equipment and receiver
- Connect the equipment into an outlet on a circuit different from that to which the receiver is connected.

Consult the dealer or an experienced radio/TV technician for help.

The NINA-B1 series modules are for OEM integrations only. The end-user product will be professionally installed in such a manner that only the authorized antennas are used.

For NINA-B111 an external antenna connector (U.FL. connector) reference design (see the NINA-B1 Series System Integration Manual [1]) is available and must be followed to comply with the NINA-B1 FCC/IC modular approval.

Any changes or modifications NOT explicitly APPROVED by u-blox could cause the module to cease to comply with FCC rules part 15, and thus void the user's authority to operate the equipment.

#### 11.2.4.1 Cautions

- Any changes or modification could cause the module to cease to comply with FCC rules part 15 and thus void the user's authority to operate the equipment.
- §15.407 statement; in case of absence of information to transmit or operational failure, the NINA-B1 module will automatically discontinue transmission.

### 11.2.5 Labelling Requirements for End Product

For an end product using the NINA-B1 modules there must be a label containing, at least, the following information:

This device contains FCC ID: XPYNINAB1 IC: 8595A-NINAB1
---

The label must be affixed on an exterior surface of the end product such that it will be visible upon inspection in compliance with the modular approval guidelines developed by the FCC.

In accordance with 47 CFR § 15.19, the end product shall bear the following statement in a conspicuous location on the device:

"This device complies with Part 15 of the FCC Rules. Operation is subject to the following two conditions;

1. This device may not cause harmful interference, and
2. This device must accept any interference received, including interference that may cause undesired operation."

When the device is so small or for such use that it is not practicable to place the statement above on it, the information shall be placed in a prominent location in the instruction manual or pamphlet supplied to the user or, alternatively, shall be placed on the container in which the device is marketed.

In case, where the final product will be installed in locations where the end-user is not able to see the

FCC ID and/or this statement, the FCC ID and the statement shall also be included in the end-product manual.

### 11.2.6 FCC and IC IDs

Model	FCC ID	IC ID
NINA-B111	XPYNINAB1	8595A-NINAB1
NINA-B112	XPYNINAB1	8595A-NINAB1

Table: FCC and IC IDs for different models of the NINA-B1 series modules

### 11.2.7 Bluetooth Qualification Information



® The NINA-B1 series modules have been qualified according to the Bluetooth version 4.2 and 5.0 specifications. For an end product with NINA-B1 integrated, no further qualification is required. If the end product is to be Bluetooth listed, the QD ID listed in Table 20 shall be included in the end product listing. Use Table 20 to select the QD ID to refer to, depending on what version of the u-connectXpress software or, for open CPU, what version of the Nordic SoftDevice is used.

Bluetooth Version	Bluetooth Product Type	QD ID	Listing Date	Nordic SoftDevice S132 version	u-connectXpress Software Version
4.2	End Product	85618	16-Aug-2016	3.0.0 to 4.0.x	1.0.0 to 3.0.1
5.0	End Product	100763	18-Sep-2017	5.0.0 or later	4.0.0 or later

Table: NINA-B1 Bluetooth QD IDs

There is a u-blox type AG OBS421 Bluetooth module fitted in the USB communications device supplied with the SWiFT. Please see section Bluetooth Module for details

### 11.2.8 Japan Radio Equipment Compliance

The NINA-B1 series modules comply with the Japanese Technical Regulation Conformity Certification of Specified Radio Equipment (ordinance of MPT N°. 37, 1981), Article 2, Paragraph 1:

- Item 19 "2.4 GHz band wide band low power data communication system"



204-610006

Giteki mark, R and the NINA-B1 MIC certification number

### 11.2.9 NCC Taiwan Compliance

#### 11.2.9.1 Taiwan NCC Warning Statement

型式認證合格之低功率射頻電機，非經許可，公司、商號或使用者均不得擅自變更頻率、加大功率或變更原設計之特性及功能。

低功率射頻電機之使用不得影響飛航安全及干擾合法通信；經發現有干擾現象時，應立即停用，並改善至無干擾時方得繼續使用。前項合法通信，指依電信法規定作業之無線電通信。低功率射頻電機須忍受合法通信或工業、科學及醫療用電波輻射性電機設備之干擾。

內含發射器模組：



CCAJ16LP6470T3

#### Statement Translation:

Without permission granted by the NCC, any company, enterprise, or user is not allowed to change frequency, enhance transmitting power or alter original characteristic as well as performance to approved low power radio-frequency devices.

The low power radio-frequency devices shall not influence aircraft security and interfere legal communications; If found, the user shall cease operating immediately until no interference is achieved. The said legal communications means radio communications is operated in compliance with the Telecommunications Act. The low power radio-frequency devices must be susceptible with the interference from legal communications or ISM radio wave radiated devices.

### 11.2.10 KCC South Korea Compliance



**11.2.11 Anatel Brazil Compliance**



“Este equipamento opera em caráter secundário, isto é, não tem direito a proteção contra interferência prejudicial, mesmo de estações do mesmo tipo, e não pode causar interferência a sistemas operando em caráter primário.”

**Statement translation:**

“This equipment operates on a secondary basis and, consequently, must accept harmful interference, including from stations of the same kind, and may not cause harmful interference to systems operating on a primary basis.”

**11.2.12 Australia and New Zealand Regulatory Compliance**



The NINA-B1 modules are compliant with AS/NZS 4268:2012/AMDT 1:2013 standard – Radio equipment and systems – Short range devices – Limits and methods of standard measurement made by the Australian Communications and Media Authority (ACMA).

**11.2.13 South Africa Regulatory Compliance**

The NINA-B1 modules are compliant and certified by the Independent Communications Authority of South Africa (ICASA). End products that are made available for sale or lease or is supplied in any other manner in South Africa shall have a legible label permanently affixed to its exterior surface. The label shall have the ICASA logo and the ICASA issued license number as shown in the figure below. The minimum width and height of the ICASA logo shall be 3 mm. The approval labels must be purchased by the customer’s local representative directly from the approval authority ICASA. A sample of a NINA-B1 ICASA label is included below:

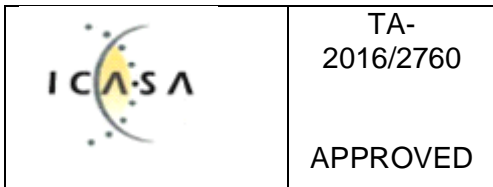

### 11.2.14 Antennas

- This radio transmitter IC: 8595A-NINAB1 has been approved by Industry Canada to operate with the antenna types listed below with the maximum permissible gain and required antenna impedance for each antenna type indicated.

For each antenna, the “Approvals” field defines in which region or market the antenna is pre-approved for use with the NINA-B1 series modules. Definitions of the «Approvals» field are:

- FCC – The antenna is approved for use in countries that accept the FCC radio approvals, primarily the US.
- IC – The antenna is approved for use in countries that accept the IC radio approvals, primarily Canada.
- RED – The antenna is approved for use in countries that accept the Radio Equipment Directive, primarily the European countries.
- MIC – The antenna is approved for use in the Japanese market.
- NCC – The antenna is approved for use in the Taiwanese market.
- KCC – The antenna is approved for use in the Korean market.
- ANATEL – The antenna is approved for use in the Brazilian market.
- ACMA – The antenna is approved for use in the Australian and New Zealand markets.
- ICASA – The antenna is approved for use in the South African market.

#### Internal Antenna

NINA-B112 (u-blox LILY antenna)	
Manufacturer	ProAnt
Gain	+3 dBi
Impedance	50 Ω
Size (HxWxL)	3.0 x 3.8 x 9.9 mm
Type	PIFA
Comment	SMD PIFA antenna on NINA-B112
Approval	FCC, IC, RED, MIC, NCC, KCC, ANATEL, ACMA and ICASA



### 11.2.15 Compliance with the RoHS directive



The NINA-B1 series modules comply with the "Directive 2011/65/EU of the European Parliament and the Council on the Restriction of Use of certain Hazardous Substances in Electrical and Electronic Equipment" (RoHS)

No natural rubbers, hygroscopic materials, or materials containing asbestos are employed.

## 11.3 PC Bluetooth Module

### 11.3.1 EU Declaration of Conformity

SWiFT CTD Profilers have u-blox type AG OBS421 stand-alone dual-mode Bluetooth® module fitted as standard. There is the same type of Bluetooth module fitted in the USB communications device supplied with the SWiFT.

It complies with the essential requirements and other relevant provisions of Radio Equipment Directive (RED) 2014/53/EU and Restriction of Hazardous Substances (RoHS) Directive 2011/65/E

Essential Requirements Radio Equipment Directive 2014/53/EU	Standards
Safety & Health (Article 3.1a)	IEC 60950-1:2005 + A1:2009 EN 60950-1:2006 + A11:2009 + A1:2010 + A12:2011 + AC:2011 + A2:2013 EN 62479:2010
EMC (Article 3.1b)	EN 301 489-1 V2.1.1 EN 301 489-17 V3.1.1 IEC 60601-1-2:2007 (Medical Electrical Equipment
Radio Spectrum Efficiency (Article 3.2)	EN 300 328 V2.1.1
Essential Requirements RoHS Directive 2011/65/EU	Standards
Prevention (Article 4.1)	EN 50581:2012

### 11.3.2 FCC Statement

This device complies with Part 15 of the FCC Rules. Operation is subject to the following two conditions:

1. this device may not cause harmful interference, and
2. this device must accept any interference received, including interference that may cause undesired operation.

### 11.3.3 Radio Frequency Exposure

The OEM Serial Port Adapter contains a small radio transmitter and receiver. During communication with other Bluetooth products the OEM Serial Port Adapter receives and transmits radio frequency (RF) electromagnetic fields (microwaves) in the frequency range 2400 to 2500 MHz. The output power of the radio transmitter is very low.

When using the OEM Serial Port Adapter, you will be exposed to some of the transmitted RF energy. This exposure is well below the prescribed limits in all national and international RF safety standards and regulations.

### 11.3.4 Potentially Explosive Atmospheres

Turn off your electronic device before entering an area with potentially explosive atmosphere. It is rare, but your electronic device could generate sparks. Sparks in such areas could cause an explosion or fire resulting in bodily injury or even death.

Areas with a potentially explosive atmosphere are often, but not always, clearly marked. They include fuelling areas, such as petrol station, below deck on boats, fuel or chemical transfer or storage facilities, and areas where the air contains chemicals or particles, such as grain, dust, or metal powders.



## 11.4 World USB Charger – 2.4A

As supplied with the SWiFT Instrument



### Declaration of conformity

We,

WorldConnet AG  
Werkstrasse 12a  
9444 Diepoldsau  
Switzerland

**declare on our own sole responsibility, to whom it may concern, that the below named product is in conformity with the applicable norms and standards.**

Typ: World USB Charger (WUC), 2.4A

**For this safety evaluation the following norms and standards are applied:**

- **IEC 60884**
  - IEC 60884-1 / A2:2013
  - IEC 60884-2-5 : 1995
  
- **EMC Directive 2014/30/EU**
  - EN55022:2010
  - EN55024:2010
  - EN61000-3-2 :2014
  - EN61000-3-3 :2013
  
- **LVD Directive 2014/35/EU**
  - IEC60950-1 (ed.2) ;am1 :2009 ;am2 :2013
  
- **FCC Part 15 Subpart B :2013**
  
- **ErP EN50564 :2011**
  
- **ICES-003 Issue 5**
  
- **ROHS2 Directive 2011/65/EU**
  
- **REACH Directive 1907/2006**

Date:  
2016-03-10

WorldConnect AG  
Werkstrasse 12a  
9444 Diepoldsau  
Switzerland

Meinrad Berchtel  
Head of Product Management

WorldConnect AG · Werkstrasse 12a, 9444 Diepoldsau, Switzerland  
T +41 (0)71 7379760 · F +41 (0)71 7379770 · info@skross.com · www.skross.com