



SONIC 2020

BROADBAND MULTIBEAM ECHOSOUNDER

Operation Manual V3.3

Revision 000 (13Apr2017)

Part No. 9600005

Version	3.3	Rev	r000
Date	13-04-2017		

Part No. 96000005

COPYRIGHT NOTICE

Copyright © 2017, R2Sonic LLC. All rights reserved

Ownership of copyright

The copyright in this manual and the material in this manual (including without limitation the text, artwork, photographs, images, or any other material in this manual) is owned by R2Sonic LLC. The copyright includes both the print and electronic version of this manual.

Copyright license

R2Sonic LLC is solely responsible for the content of this manual. Neither this manual, nor any part of this manual, may be copied, translated, distributed or modified in any manner without the express written approval of R2Sonic LLC.

Permissions

You may request permission to use the copyright materials in this manual by writing to r2support@r2sonic.com

Authorship

This manual (Sonic 2020 Operation Manual), and all of the content therein, written by:

R2Sonic LLC

5307 Industrial Oaks Blvd, Suite 120

Austin, Texas 78735

USA

Telephone: +1 (512) 891 0000

Version Printing History

- March 2013 Version 1.0
- October 2013 Version 2.0
- February 2014 Version 3.0
- June 2016 Version 3.1
- November 2016 Version 3.2 (MultiSpectral Mode™ feature)
- April 2017 Version 3.3 (UHD, MulitMode with PipeTrac™ feature)

R2Sonic LLC reserves the right to amend or edit this manual at any time. R2Sonic LLC offers no implied warranty concerning the information in this manual. R2Sonic LLC shall not be held liable for any errors within the manual.

Version	3.3	Rev	r000
Date	13-04-2017		

IMPORTANT NOTICE

Pursuant to the United States Department of Commerce Bureau of Industry and Security Export rules and regulations, under Export Control Classification Number (ECCN) 6A991 and 6A001, a minor modification has been made in the range and frequencies available in the R2Sonic Multibeam Echosounder family only for those systems that are **submerged to 100 metres depth or greater**. R2Sonic Multibeam Echosounders now come in either a Standard Spectrum (with the restriction) or a Full Spectrum (no restriction) version.

The Standard Spectrum system will have the aforementioned restrictions applied only when submerged to a depth greater than 100 metres. A Standard Spectrum system, when submerged to depths greater than 100 metres, will be restricted to operating frequencies of no less than 350 kHz and ranges no greater than 200 metres. There are no such restrictions for submerged depths of less than 100 metres or for a Full Spectrum system.

The R2Sonic Multibeam Echosounders Full Spectrum version have no such modifications, but are subject to possible export control restrictions (please see the local R2Sonic representative for a clarification of the rules and laws that apply to the country of interest).

The rules and regulations, under which this notice applies, are subject to change at any time and without notice.

Version	3.3	Rev	r000
Date	13-04-2017		

Table of Contents

1	INTRODUCTION	19
1.1	<i>Outline of Equipment.....</i>	19
1.2	<i>How to use this Manual.....</i>	20
1.2.1	Standard of Measurement.....	20
2	SONIC SPECIFICATIONS.....	21
2.1	<i>Sonic 2020 System Specification.....</i>	21
2.2	<i>Sonic 2020 Dimensions and Weights.....</i>	21
2.3	<i>Sonic 2020 Electrical Interface.....</i>	21
2.4	<i>Sonic 2020 Ping Rates (SV = 1500m/sec).....</i>	22
2.5	<i>Acoustic Centre.....</i>	23
3	SONIC 2020 SONAR HEAD INSTALLATION – Surface Vessel	25
3.1	<i>Mounting the Sonic 2020.....</i>	25
3.1.1	Mounting the sound velocity probe	26
3.1.2	Sonar Deck lead	27
3.1.3	Sound velocity probe deck lead	27
3.2	<i>Deck Test Prior to Deployment.....</i>	30
3.2.1	Communications test.....	30
3.2.2	Receiver rub test.....	30
3.2.3	Problems with Deck Test.....	30
3.3	<i>Sonar Head Installation Guidelines</i>	31
3.3.1	Introduction.....	31
3.3.2	Over-the-Side mount.....	31
3.3.3	Moon Pool Mount.....	32
3.3.4	Hull Mount.....	32
3.3.5	ROV Mounting.....	32
4	SONIC 2020 SONAR INTERFACE MODULE (SIM) INSTALLATION and INTERFACING	33
4.1	<i>Sonar Interface Module (SIM)</i>	33
4.1.1	Physical installation.....	33
4.1.2	Electrical and Interfacing	34
4.1.3	Serial Communication.....	37

Version	3.3	Rev	r000
Date	13-04-2017		

4.1.4	Time and PPS input.....	37
4.1.5	Motion Input.....	38
4.1.6	SVP input.....	38
5	OPERATION OF THE SONIC 2020 VIA SONIC CONTROL	41
5.1	<i>Installing Sonic Control Graphical User Interface</i>	<i>41</i>
5.2	<i>Hot Keys</i>	<i>41</i>
5.3	<i>Settings Menu</i>	<i>42</i>
5.4	<i>Network Setup.....</i>	<i>42</i>
5.4.1	Initial Computer setup for Communication.....	42
5.4.2	Discover Function.....	43
5.4.3	Configuring Network Communication.....	45
5.5	<i>Sensor Setup (Serial Interfacing).....</i>	<i>47</i>
5.5.1	Ethernet Interfacing.....	47
5.5.2	GPS.....	48
5.5.3	Motion	48
5.5.4	Heading.....	48
5.5.5	SVP.....	48
5.5.6	Trigger In / Trigger out.....	49
5.6	<i>Sonar Settings (Hotkey: F2).....</i>	<i>50</i>
5.6.1	Frequency (kHz)	51
5.6.2	700 kHz UHR (Optional).....	51
5.6.3	UHR Operation Suggestions	51
5.6.4	Ping Rate Limit	51
5.6.5	Sector Coverage.....	52
5.6.6	Sector Rotate	53
5.6.7	Minimum Range Gate (m)	54
5.6.8	Bottom Sampling	54
5.6.9	Ultra High Density (UHD™)	56
5.6.10	Mission Mode	57
5.6.11	Imagery.....	57
5.6.12	Roll Stabilize and Pitch Stabilize	61
5.6.13	Dual Head Mode (Also see APPENDIX VII.)	62

5.6.14	TruePix™, Snippets, Water Column, Intensity Enable	64
5.6.15	Water Column Data Collection.....	65
5.7	<i>MultiMode</i>	66
5.7.1	MultiSpectral Mode™	66
5.7.2	Pipeline Mode.....	67
5.8	<i>Ocean Setting</i>	69
5.8.1	Absorption: 0 – 200 dB/km.....	69
5.8.2	Spreading Loss: 0 – 60 dB	69
5.8.3	Time Variable Gain.....	70
5.9	<i>Installation Settings</i>	73
5.9.1	Projector Orientation	73
5.9.2	Projector Z Offset (m)	73
5.9.3	Head Tilt	73
5.10	<i>Status</i>	74
5.10.1	System Status	74
5.10.2	Saturation Monitor.....	75
5.10.3	TruePix Monitor	76
5.11	<i>Tools</i>	77
5.11.1	Engineering.....	77
5.11.2	Firmware Update.....	77
5.11.3	Snapshot and Reset Sector Rotate	80
5.12	<i>Help</i>	80
5.12.1	Help Topics.....	80
5.12.2	Options.....	80
5.12.3	Remote Assistance	80
5.12.4	About Sonic Control.....	81
5.13	<i>Display settings</i>	82
5.14	<i>Imagery</i>	83
5.14.1	TruePix™ and Water Column.....	83
5.14.2	Video Capture.....	83
5.15	<i>ROBO Automatic Sonar Operation</i>	84
5.15.1	ROBO Settings	84

Version	3.3	Rev	r000
Date	13-04-2017		

- 5.16 *Main Operation Parameters* 86
 - 5.16.1 Range: 0 – 1200 metres 86
 - 5.16.2 RangeTrac™ – Sonic Control automatically sets correct range 88
 - 5.16.3 Power: 177 – 207 dB..... 88
 - 5.16.4 Pulse Length: 15µsec – 1115µsec 88
 - 5.16.5 Gain: 1 – 45..... 89
 - 5.16.6 Depth Gates: GateTrac™ 89
- 5.17 *GUI Rec(ord)*..... 92
- 5.18 *Ruler* 92
- 5.19 *Save Settings* 93
 - 5.19.1 Default setting ini file..... 93
- 5.20 *Operating Sonic Control on a second computer*..... 93
 - 5.20.1 Two computer setup 94
 - 5.20.2 Changing back to one computer 95
- 6 SONIC 2020 THEORY OF OPERATION96**
 - 6.1 *Sonic 2020 Sonar Head Block Diagram* 96
 - 6.2 *Sonic 2020 Transmit (Normal Operation Mode)*..... 97
 - 6.3 *Sonic 2020 Receive (Normal Operation Mode)*..... 98
 - 6.4 *Sonic 2020 Sonar Interface Module (SIM) Block Diagram* 99
 - 6.4.1 Sonar Interface Module (SIM) Block Diagram..... 99
- 7 Appendix I: R2Sonic I2NS Components and Operation100**
 - 7.1 *Components* 100
 - 7.2 *Mounting the IMU on the Sonic 2020 mounting frame*..... 101
 - 7.3 *Installing the IMU and GPS antennas* 102
 - 7.4 *Connection diagram*..... 103
 - 7.4.1 INS BNC – TNC Connections..... 104
 - 7.4.2 I2NS DB9 Connections..... 105
 - 7.5 *Setup in Sonic Control* 106
 - 7.5.1 Network Setup 106
 - 7.5.2 Applanix Group 119 specific to R2Sonic SIMINS..... 107
 - 7.5.3 Sensor Setup 108
 - 7.5.4 INS Monitor (Alt+I) 108

Version	3.3	Rev	r000
Date	13-04-2017		

7.6	<i>Measuring IMU Offsets</i>	109
7.7	<i>Sonic 2020 and IMU offsets when mounted</i>	111
7.7.1	Vertical Relationship.....	111
7.7.2	Horizontal Relationship	112
7.8	<i>I2NS Physical Specifications</i>	113
7.9	<i>I2NS Drawings</i>	114
7.9.1	I2NS IMU	114
7.9.2	I2NS Sonar Interface Module (SIM)	115
8	APPENDIX II: Multibeam Survey Suite Components	117
8.1	<i>Auxiliary Sensors and Components</i>	117
8.2	<i>Differential Global Positioning System</i>	117
8.2.1	Installation.....	117
8.2.2	GPS Calibration.....	118
8.3	<i>Gyrocompass</i>	119
8.3.1	Gyrocompass Calibration Methods	119
8.4	<i>The Motion Sensor</i>	124
8.5	<i>Sound Velocity Probes</i>	125
8.5.1	CTD Probes.....	126
8.5.2	Time of Flight Probe	127
8.5.3	XBT Probes	127
8.6	<i>The sound velocity cast</i>	128
8.6.1	Time of Day	128
8.6.2	Fresh water influx	128
8.6.3	Water Depth.....	128
8.6.4	Distance	128
8.6.5	Deploying and recovering the Sound Velocity Probe	128
9	APPENDIX III: Multibeam Surveying	131
9.1	<i>Introduction</i>	131
9.2	<i>Survey Design</i>	131
9.2.1	Line Spacing.....	131
9.2.2	Line Direction.....	131

Version	3.3	Rev	r000
Date	13-04-2017		

9.2.3	Line Run-in	132
9.3	<i>Record Keeping</i>	132
9.3.1	Vessel Record	132
9.3.2	Daily Survey Log	133
10	APPENDIX IV: Offset Measurements	137
10.1	<i>Lever Arm Measurement – Offsets</i>	137
10.2	<i>Vessel Reference System</i>	137
10.3	<i>Measuring Offsets</i>	138
10.3.1	Sonic 2020 Acoustic Centre	138
10.3.2	Horizontal Measurement	138
10.3.3	Vertical Measurement	139
11	APPENDIX V: The Patch Test	141
11.1	<i>Introduction</i>	141
11.2	<i>Orientation of the Sonic 2020 Sonar Head</i>	141
11.3	<i>Patch Test Criteria</i>	142
11.3.1	Latency Test	142
11.3.2	Roll Test	143
11.3.3	Pitch Test	144
11.3.4	Yaw Test	145
11.4	<i>Solving for the Patch Test</i>	146
11.5	<i>History</i>	146
11.6	<i>Basic data collection criteria</i>	147
11.7	<i>Patch Test data collection error areas</i>	147
11.7.1	Positioning	147
11.7.2	Feature chosen for test	147
11.7.3	Water depth	147
11.7.4	Use predefined survey lines	148
11.7.5	Speed	148
11.7.6	Vessel line up	148
11.7.7	Pole variability	148
11.8	<i>Improving the Patch Test and Patch Test results</i>	149
11.8.1	Need to collect sufficient data	149

Version	3.3	Rev	r000
Date	13-04-2017		

11.8.2	Individually solving values.....	150
11.9	<i>Truthing the patch test</i>	150
12	APPENDIX VI: Basic Acoustic Theory	151
12.1	<i>Introduction</i>	151
12.2	<i>Sound Velocity</i>	151
12.2.1	Salinity.....	153
12.2.2	Temperature.....	153
12.2.3	Refraction Errors.....	153
12.3	<i>Transmission Losses</i>	154
12.3.1	Spreading Loss.....	154
12.3.2	Absorption.....	155
12.3.3	Reverberation and Scattering.....	160
13	APPENDIX VII: Sonic 2020 Mounting: Sub-Surface (ROV/AUV)	161
13.1	<i>Installation Considerations</i>	161
13.1.1	Ethernet wiring considerations.....	162
13.2	<i>Data Rates</i>	162
13.3	<i>ROV Installation Examples</i>	163
13.4	<i>Power Requirements</i>	165
13.4.1	Common mode noise rejection.....	166
13.4.2	SIM Power connections.....	167
13.5	<i>SIM Installation – ROV</i>	168
13.6	<i>SIM Installation – AUV</i>	169
13.7	<i>SIM Board Physical Installation</i>	170
13.8	<i>SIM Stack LED Status Indicators</i>	170
13.8.1	SIM Board Dimensional Information.....	171
13.8.2	SIM Board Images.....	172
13.9	<i>Dual Sonar Head</i>	173
13.9.1	Dual Head Installation.....	173
13.9.2	Operation.....	173
14	APPENDIX VIII: R2Sonic Control Commands	175
14.1	<i>Introduction</i>	175

Version	3.3	Rev	r000
Date	13-04-2017		

- 14.2 *General Notes* 175
 - 14.2.1 Ethernet Port Numbers..... 175
 - 14.2.2 Type Definitions..... 175
 - 14.2.3 Command Packet Format..... 175
- 14.3 *Head Commands, Binary Format* 176
- 14.4 *SIM Commands, Binary Format* 179
- 14.5 *GUI Commands, Binary Format* 181
 - 14.5.1 **GUI Command Line Switches** 181
- 14.6 *Command Examples Sent to the Sonar Head and SIM* 182
- 15 APPENDIX IX: R2Sonic Uplink Data Formats** **184**
 - 15.1 *Introduction*..... 184
 - 15.2 *General Notes* 184
 - 15.3 *Port Numbers* 184
 - 15.4 *Type Definitions*..... 184
 - 15.5 *Ethernet Data Rates*..... 185
 - 15.6 *Bathymetry Packet Format* 186
 - 15.7 *Snippet Format*..... 189
 - 15.8 *Water Column (WC) Data Format*..... 191
 - 15.9 *Acoustic Image (AI) Data Format*..... 194
 - 15.10 *TruePix™ Data Format* 196
 - 15.11 *Head Status Format* 198
 - 15.12 *SIM Status Data Format*..... 201
 - 15.13 *Device Status Format* 203
 - 15.14 *Data Playback Using Bit-Twist* 204
 - 15.14.1 Introduction..... 204
 - 15.14.2 Capturing Data..... 204
 - 15.14.3 Editing Data..... 205
 - 15.14.4 Data Playback..... 206
- 16 APPENDIX X: Drawings** **207**

Version	3.3	Rev	r000
Date	13-04-2017		

List of Figures

Figure 1: Sonic 2020 Block Diagram	19
Figure 2: Sonic 2020 Acoustic Centre	23
Figure 3: Sonic 2020 Acoustic Centre wrt the Mounting Frame	23
Figure 4: Sonic 2020 mounting frame	25
Figure 5: 2020 mounting frame – face	26
Figure 6: Correct order for securing the sonar in the frame	26
Figure 7: Sonic 2020 deck lead connection and SV probe are aft	27
Figure 8: R2C 2020 Mounting Frame.....	28
Figure 9: R2C Mounting frame drawing	28
Figure 10: Typical over-the-side mount	31
Figure 11: Sonar Interface Module (SIM)	33
Figure 12: Removal of trim to expose securing holes	34
Figure 13: SIM Interfacing Physical Connections	35
Figure 14: SIM Interfacing Guide (from label on top of the SIM).....	35
Figure 15: SIM IEC mains connection and deck lead Amphenol connector.....	36
Figure 16: Wet end connector.....	36
Figure 17: TTL input/output (PPS and Sync In/Out) schematic	37
Figure 18: Sonic Control Icon on desktop.....	41
Figure 19: Sonic Control 2000	41
Figure 20: Settings Menu	42
Figure 21: Windows Internet Adaptor Properties.....	43
Figure 22: IP and Subnet mask setup	43
Figure 23: Sonic Control Network setup	44
Figure 24: Set INS IP	45
Figure 25: Set IP Time Expired.....	45
Figure 26: Command prompt-ipconfig/all.....	45
Figure 27: Sensor communication settings	47
Figure 28: Sensor Ethernet communications settings.....	48
Figure 29: Trigger In/Out Options	49
Figure 30: Settings Menu	50
Figure 31: Sonar Operation Settings window.....	50
Figure 32: Operating Frequency Selection	51
Figure 33: Ping Rate Limit.....	52
Figure 34: Sector Coverage.....	52
Figure 35: Asymmetric sector sizing.....	53
Figure 36: Sector Rotate.....	53
Figure 37: Bottom Sampling Modes	54
Figure 38: Example of going from normal to Quad mode.....	55
Figure 39: Indication of Bottom Sampling Mode	56

Version	3.3	Rev	r000
Date	13-04-2017		

Figure 40: Highlighted indicator for equiangular operation 56

Figure 41: Normal Mission Mode selections 57

Figure 42: Mission Mode with the FLS Option Installed 57

Figure 43: Enable Acoustic Image in the wedge display 58

Figure 44: FLS Wide mode 58

Figure 45: Imagery palette selection in Display Options 58

Figure 46: Stealth mode single Ping button..... 59

Figure 47: Settings menu FLS settings option 59

Figure 48: Sonic 2020/2026 FLS Options 59

Figure 49: Roll and Pitch Stabilize 61

Figure 50: Dual Head Mode 62

Figure 51: Dual Head Mode active..... 62

Figure 52: Load Settings menu selection 63

Figure 53: Loading an .ini file 63

Figure 54: Default dual head Network settings 63

Figure 55: TruePix™ image of wreck debris and sea grass 64

Figure 56: Network Card Properties 65

Figure 57: Intel NIC Properties..... 65

Figure 58: MultiMode Window..... 66

Figure 59: Settings | MultiMode..... 66

Figure 60: MultiMode Selections..... 66

Figure 61: MultiMode Preset Settings 66

Figure 62: Preset warning 67

Figure 63: Capture settings prompt..... 67

Figure 64: Dual Head Multimode..... 68

Figure 65: Pipeline Mode (image courtesy of DOF Subsea)..... 68

Figure 66: Ocean Characteristics 69

Figure 67: Absorption Calculator 69

Figure 68: TVG Curve Concept 71

Figure 69: The angular acoustic wave front will strike each receive element at a different time 72

Figure 70: Installation Settings..... 73

Figure 71: Status Options..... 74

Figure 72: Status Message 74

Figure 73: Status | Saturation Monitor..... 75

Figure 74: Saturation Monitor 75

Figure 75: TruePix Monitor 76

Figure 76: TruePix monitor palette..... 76

Figure 77: Select Tools; Firmware Update..... 77

Figure 78: The Browse button will open the current GUI's directory..... 78

Figure 79: Select correct update .bin file 78

Figure 80: A batch file will automatically load the upgrade file 78

Version	3.3	Rev	r000
Date	13-04-2017		

Figure 81: The start of a firmware update. A series of dots represents the update progress..... 78

Figure 82: Firmware update completed, the window will close automatically and the Update window will show successful completion 79

Figure 83: Indication of attempts to update firmware 79

Figure 84: Help Menu 80

Figure 85: Installed Options 80

Figure 86: Remote Assistance 81

Figure 87: Remote Assistance Window..... 81

Figure 88: About, provides the GUI version 81

Figure 89: Display Settings 82

Figure 90: Imagery Settings 83

Figure 91: Enabling ROBO Operation 84

Figure 92: Operational settings with ROBO active 84

Figure 93: ROBO Settings 84

Figure 94: ROBO Settings Table..... 85

Figure 95: In ROBO Settings, View Link to the ini file..... 85

Figure 96: Operating parameter buttons 86

Figure 97: Range setting represented in the wedge display 87

Figure 98: Graphical concept of the Wedge Display 87

Figure 99: RangeTrac enabled 88

Figure 100: Transmit Pulse 89

Figure 101: Enable Gates..... 89

Figure 102: Manual and GateTrac selections 90

Figure 103: Manually adjust the gate slope 90

Figure 104: Gate width tolerance toggle..... 90

Figure 105: GateTrac enabled; Gate min and max control is disabled 90

Figure 106: GateTrac: Depth + Slope enabled, manual gate controls are disabled..... 91

Figure 107: GateTrac: Depth + Slope enabled and tracking a steep slope 91

Figure 108: Graphical representation of depth gate..... 92

Figure 109: Ruler Function 93

Figure 110: Change in GUI IP 94

Figure 111: Sonic 2020 Sonar Head Block Diagram..... 96

Figure 112: Transmit pattern..... 97

Figure 113: Receive pattern with Transmit pattern 98

Figure 114: Sonar Interface Module Block Diagram 99

Figure 115: R2Sonic I2NS Main Components (not including antennas and cables)..... 100

Figure 116: GNSS Antennas..... 100

Figure 117: IMU mounted within the Sonic 2022 mounting frame 101

Figure 118: Detail of securing IMU and Sonic 2020 101

Figure 119: Aft detail of the IMU cable connection 102

Figure 120: INS connections 103

Version	3.3	Rev	r000
Date	13-04-2017		

Figure 121: INS SIM block diagram 103

Figure 122: INS BNC & TNC Connections 104

Figure 123: PPS Out - PPS In..... 104

Figure 124: Com 1 and Com 2 105

Figure 125: POSView Serial port setup 105

Figure 126: Network Settings SIMINS 106

Figure 127: Cannot Change IP, waiting on msg 32 106

Figure 128: Set IP time expired, cannot change IP 106

Figure 129: Sensor setup SIMINS 108

Figure 130: INS Monitor 108

Figure 131: IMU Reference indicators 109

Figure 132: POSView Lever Arm setup 110

Figure 133: View of installation with the entered offsets 110

Figure 134: 2020-INS Vertical Offsets 111

Figure 135: 2020 INS Horizontal Offsets 112

Figure 136: IMU Drawing 114

Figure 137: I2NS SIM Drawing 115

Figure 138: Gyrocompass Calibration method 1 121

Figure 139: Gyro Calibration Method 2 122

Figure 140: Gyro Calibration Method 2 example 123

Figure 141: Idealised concept of Gyro Calibration Method 2 123

Figure 142: CTD Probe 126

Figure 143: Time of Flight SV probe..... 127

Figure 144: Deploying a sound velocity probe via a winch or A - Frame..... 130

Figure 145: Rough log, kept during survey operations...does not need to be neat, but must contain all pertinent information 135

Figure 146: Smooth log; information copied from real-time survey log 136

Figure 147: Vessel Horizontal and Vertical reference system 138

Figure 148: Sonic 2020 Acoustic Centre 138

Figure 149: Sonic 2020 axes of rotation..... 141

Figure 150: Latency Data collection..... 142

Figure 151: Roll data collection..... 143

Figure 152: Roll data collections 143

Figure 153: Pitch data collections 144

Figure 154: Yaw data collection 145

Figure 155: In 1822 Daniel Colloden measuring velocity in Lake Geneva. 151

Figure 156: Concept of refraction due to different sound velocities in the water column..... 152

Figure 157: Sound velocity profile 152

Figure 158: Refraction Error indication..... 153

Figure 159: Concept of Spherical Spreading 154

Figure 160: Concept of Cylindrical Spreading 155

Version	3.3	Rev	r000
Date	13-04-2017		

Figure 161: Sound Absorption Graphs 158

Figure 162: Single Head ROV Installation scheme A 163

Figure 163: Single Head ROV Installation scheme B (Preferred)..... 163

Figure 164: Dual Head ROV Installation scheme A..... 164

Figure 165: Dual Head ROV Installation scheme B (Preferred) 164

Figure 166: Sonic 2020 power supply current waveform. Peak current is 0.60A at 48V..... 165

Figure 167: Inrush current to 2020 head during power up, 20 ms window. 166

Figure 168: Inrush current to the 2020 head during power up, 1 second window. 166

Figure 169: Power supply choke installation on 48VDC power 167

Figure 170: SIM Controller Power Connections 167

Figure 171: J6 Connector on SIM Controller board..... 167

Figure 172: ROV installation block diagram with the SIM top-side 168

Figure 173: ROV installation block diagram with the SIM controller board mounted in the vehicle electronics bottle and GPS (ZDA or UTC formats) and PPS signals are supplied by the top-side 168

Figure 174: ROV installation block diagram with the SIM controller board mounted in the vehicle electronics bottle. GPS (ZDA or UTC formats) and PPS signals are supplied by the vehicle. 168

Figure 175: Typical wiring. GPS (ZDA or UTC formats) and PPS signals are supplied by the vehicle . 169

Figure 176: SIM Board Stacks 169

Figure 177: SIM Stack Height..... 169

Figure 178: SIM Controller Board installation dimensions..... 171

Figure 179: SIM Stack Outline 171

Figure 180: Assembled SIM Boards 172

Figure 181: SIM Boards height 172

Figure 182: Default .ini settings file..... 173

Figure 183: Dual head IP and UDP defaults..... 173

Figure 184: Dual-sonar head ping modes..... 174

Figure 185: Dual Head - Dual SIM external interfacing 174

Figure 186: Wireshark Capture Options..... 205

Figure 187: Sonic 2020 208

Figure 188: Sonic 2020 array face in mounting frame 209

Figure 189: Sonic 2020 front view, in mounting frame..... 210

Figure 190: Sonic 2020 mounting frame, top view, flange attachment..... 211

Figure 191: R2C 2020 Mounting Bracket..... 212

Figure 192: R2C Flange 213

Figure 193: SIM Box Drawing 214

Figure 194: SIM Stack Outline 215

Figure 195: R2Sonic Deck lead minimum connector passage dimensions 216

Figure 196: I2NS IMU Dimensions..... 217

Figure 197: I2NS SIM Dimensions..... 218

Version	3.3	Rev	r000
Date	13-04-2017		

List of Tables

Table 1: Metric to Imperial conversion table.....	20
Table 2: System Specification	21
Table 3: Component Dimensions and Mass.....	21
Table 4: Electrical Interface.....	21
Table 5: Ping Rate table	22
Table 6: Deck Lead Pin Assignment (Gigabit Ethernet and Power)	36
Table 7: DB-9M RS-232 Standard Protocol	37
Table 8: SIM DB-9M Serial pin assignment	37
Table 9: Sonic 2020 FLS Vertical Beamwidth	60
Table 10: I2NS Dimensions and Mass	113
Table 11: Electrical Specification	113
Table 12: Gyro Calibration Method 2 computation.....	123
Table 13: Absorption Values for Seawater and Freshwater at 400 kHz and 200 kHz.....	156
Table 14: Operating Frequency - water temperature - absorption	159
Table 15: Systems Power Requirements	165
Table 16: SIM Gigabit switch speed indicators	170

List of Graphs

Graph 1: Depth errors due to incorrect roll alignment.....	143
Graph 2: Position errors as a result of pitch misalignment	144
Graph 3: Along track position error caused by 0.5° error in yaw patch test	145
Graph 4: Along-track position error caused by 1.0° error in yaw patch test error.....	146
Graph 5: Seawater Absorption (Salinity 35ppt)	157
Graph 6: Freshwater Absorption	157

Version	3.3	Rev	r000
Date	13-04-2017		

1 INTRODUCTION

1.1 Outline of Equipment

The R2Sonic Sonic 2020 Multibeam Echosounder (MBES) is based on fifth generation Sonar Architecture that networks all of the modules and embeds the processor and controller in the sonar head to make for a very simple installation. The Sonic Control Graphical User Interface (GUI) is a simple program that can be installed on any Windows based computer and allows the surveyor to control the operating parameters of the Sonic 2020. Sonic Control communicates with the Sonar Interface Module (SIM) via Ethernet. The SIM supplies power to the sonar head, synchronises multiple heads, time tags sensor data, relays commands to the sonar head, and routes the raw multibeam data to the customer's Data Collection Computer (DCC).

The Sonic 2020 works on a user selectable frequency range of 200 kHz to 400 kHz so it is adaptable to a wide range of survey depths and conditions. The user can adjust the operating frequency, via the Sonic Control GUI, *on the fly*, without having to shut down the sonar system or change hardware or halt recording data. The Sonic 2020 has a user selectable opening angle, from 10° to 130°, using all 256 beams; the desired opening angle can be selected *on the fly* without a halt to data recording. The selected swath angle can also be rotated port or starboard, whilst recording, to direct the highly concentrated beams towards the desired target. Both the opening angle and swath rotation can be controlled via the mouse cursor.

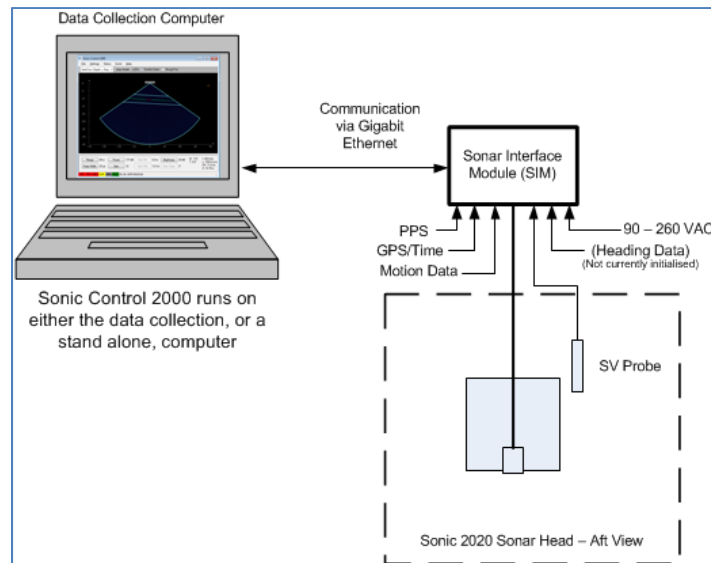

Figure 1: Sonic 2020 Block Diagram

Version	3.3	Rev	r000
Date	13-04-2017		

1.2 How to use this Manual

This manual is designed to cover all aspects of the installation and operation of the Sonic 2020. It is, therefore, recommended that the user read through the entire Operation Manual before commencing the installation or use of the equipment.

1.2.1 Standard of Measurement

The Metric system of measurement is utilised throughout this manual; this includes temperature in degrees Celsius.

METRIC	IMPERIAL
10mm (0.010m)	0.39 inches
100mm (0.100m)	3.9 inches
1000mm (1.0 metre)	39.4 inches
100 grams (0.100kg)	3.5 ounces
1000 grams (1.0 kilogram)	2.2 pounds
10° C	50°F

Table 1: Metric to Imperial conversion table

2 SONIC SPECIFICATIONS

2.1 Sonic 2020 System Specification

System Feature	Specification
Frequency	400kHz to 200kHz (700kHz optional)
Beamwidth – Across Track (at nadir)	2.0° @ 400kHz / 4.0° @ 200kHz
Beamwidth – Along Track (at nadir)	2.0° @ 400kHz / 4.0° @ 200kHz
UHR Beamwidth (at nadir)	1.0° x 1.0°
Number of Beams	256
Swath Sector	10° to 130° (user selectable) (optional 160°)
UHR Swath Sector	10° to 70° (user selectable)
Maximum Slant Range	1200 metres
Pulse Length	15µSec – 1000µSec
Pulse Type	Shaped Continuous Wave (CW)
Depth Rating	100 metres (3000 metres optional)
Operating Temperature	-10° C to 40° C
Storage Temperature	-30° C to 55° C

Table 2: System Specification

2.2 Sonic 2020 Dimensions and Weights

Component	Dimensions (L x W x D) / Dry Weight
Sonar Head	140mm x 161mm x 133.5mm
Sonar Interface Module (SIM)	280mm x 170mm x 60mm / 2.4kg
I2NS Sonar Interface Module (SIM)	280mm x 170mm x 126.4mm / 4.2kg
Sonar Head mass	4.4kg (in Air); 1.5kg (in Fresh Water)

Table 3: Component Dimensions and Mass

2.3 Sonic 2020 Electrical Interface

Item	Specification
Mains Power	90 – 260 VAC; 45 – 65 Hz
Power Consumption (SIM and Sonar Head)	37w
Power Consumption (Sonar Head Only)	22w
Uplink/Downlink	100/1000Base-T Ethernet
Data Interface	100/1000Base-T Ethernet
Sync IN/OUT	TTL
GPS Timing	1PPS; RS232 NMEA
Auxiliary Sensors	RS232 / Ethernet
Deck Cable Length	15 metre (optional to 50 metres)

Table 4: Electrical Interface

NB. The Integrated Inertial Navigation System (I2NS) Electrical specifications are in [Appendix I](#)

Version	3.3	Rev	r000
Date	13-04-2017		

2.4 Sonic 2020 Ping Rates (SV = 1500m/sec)

RANGE	PING RATE
2 - 7	60.0
10	55.4
15	39.4
20	30.6
25	25.0
30	21.1
35	18.3
40	16.1
50	13.0
70	9.4
100	6.7
150	4.5
200	3.4
250	2.7
300	2.3
400	1.7
450	1.5
500	1.4
700	1.0
1000	0.7
1200	0.6

Table 5: Ping Rate table

WARNING

THE RECEIVE MODULE IS FILLED WITH OIL THAT WILL FREEZE TO A SOLID AT -10°C. STORAGE BELOW THIS TEMPERATURE (TO -30°C) IS POSSIBLE IF THE HEAD IS SLOWLY THAWED OUT PRIOR TO OPERATION.

2.5 Acoustic Centre

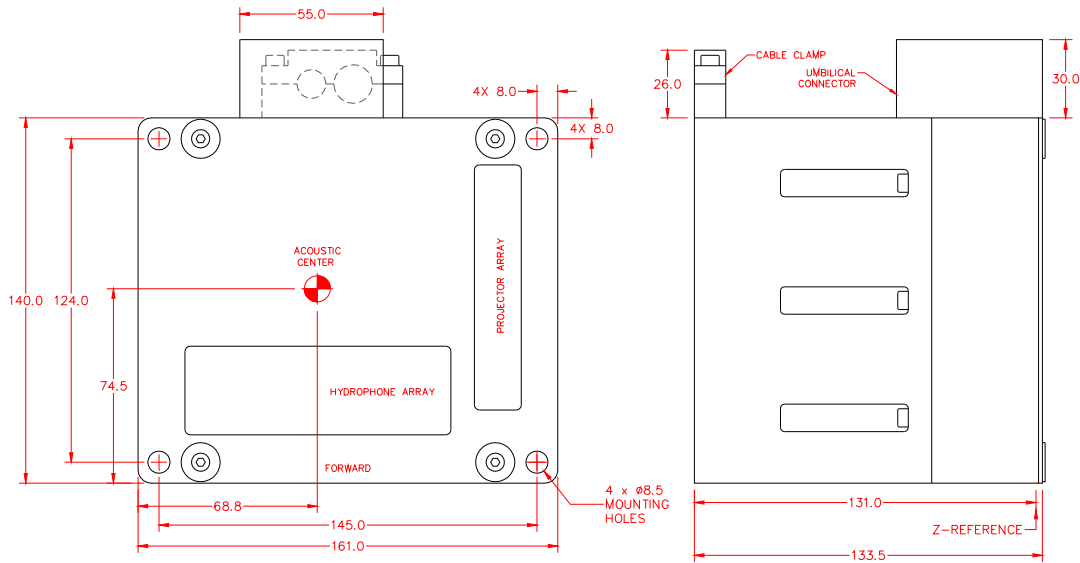

Figure 2: Sonic 2020 Acoustic Centre

When the Sonic 2020 is installed in the standard mounting frame the offsets, from the centre of the mounting frame, to the Sonic 2020 acoustic centre are:

Top of Mounting Frame to Sonic 2020 Z reference = 282.9mm (11.14 inches)

Centre of Mounting Frame to Sonic 2020 X and Y reference:

Y (forward) = 9.2mm (0.36 inches)

X (athwartship) = 11.8mm (0.46 inches)

For the 2020 INS offsets, including the IMU, please see [Appendix I](#)

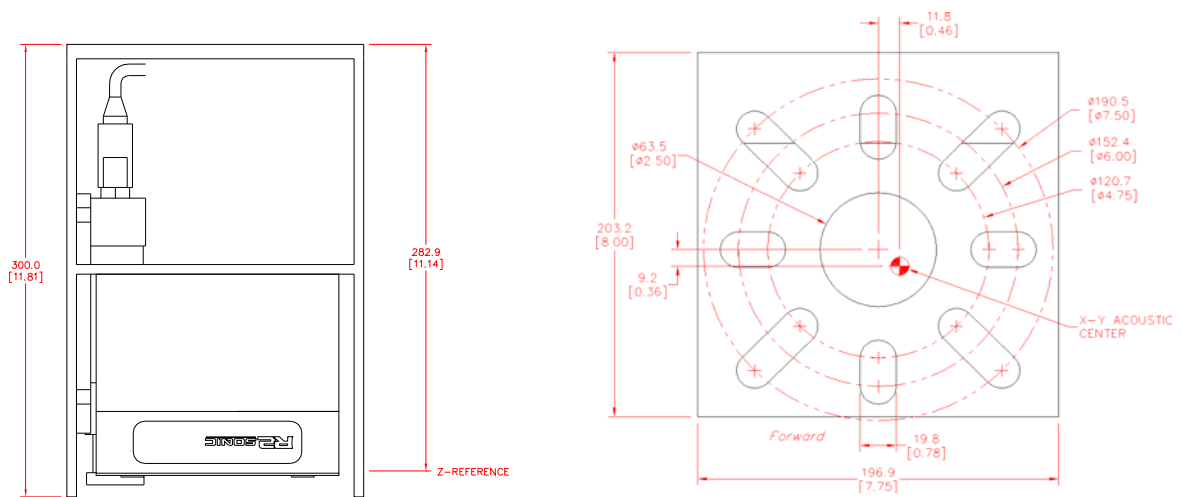

Figure 3: Sonic 2020 Acoustic Centre wrt the Mounting Frame

Version	3.3	Rev	r000
Date	13-04-2017		

Version	3.3	Rev	r000
Date	13-04-2017		

Part No. 96000005

3 SONIC 2020 SONAR HEAD INSTALLATION – Surface Vessel

The Sonic 2020 can be installed on an over-the-side pole, through a moon pool, or as a permanent hull mount.

WARNING
DECK LEAD MINIMUM BEND RADIUS = 100MM

3.1 Mounting the Sonic 2020

The Sonic 2020 mounting frame has been designed to accommodate a wide variety of flanges. The Sonic 2020 mounting frame has also been designed to accommodate the R2Sonic IMU in a tightly aligned manner.

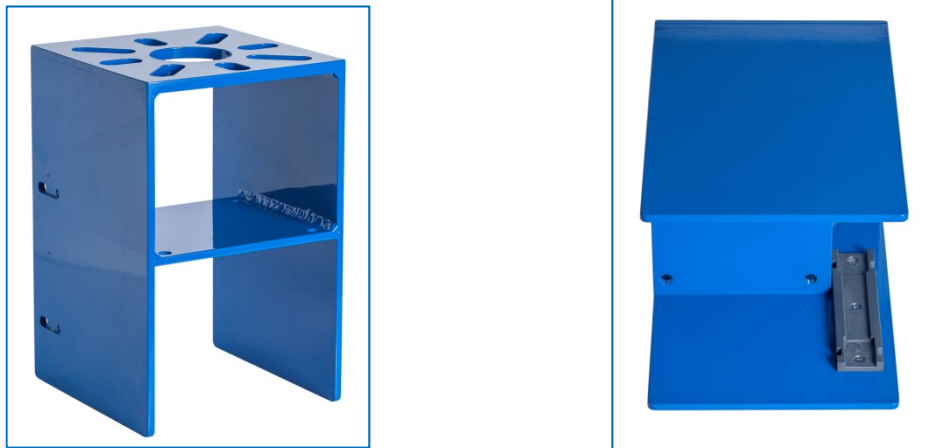

Figure 4: Sonic 2020 mounting frame

Pass the long bolts through each corner of the Sonic 2020. The bolt and nut are made of stainless steel and do not require Teflon™ tape around the bolt threads.

Set the frame, over the sonar, and align the mounting frame bolt holes to meet the sonar head bolts. Alternatively, the frame can be placed on its side and the sonar head placed into the mounting frame. Make sure that the Impulse connector is facing to the rear of the mounting frame as seen in Figure 2.

Version	3.3	Rev	r000
Date	13-04-2017		



Figure 5: 2020 mounting frame – face

To secure the sonar head, in the mounting frame, place a isolation bushing over each bolt and make sure that the bushing's raised collar is facing down and inserted into the bolt hole. Place a flat, ring, washer over the bolt and then the split (or lock) washer. The nut should be tightened to no greater than **17Newton metre** (150 pound-inch or 12.5 pound-foot).



Figure 6: Correct order for securing the sonar in the frame

3.1.1 Mounting the sound velocity probe

The sound velocity probe is mounting to the rear of the sonar. There is an insert, into which the probe is placed. Figure 4, below, shows the correct orientation of the sound velocity probe. The probe is held in place by cable ties.

Version	3.3	Rev	r000
Date	13-04-2017		

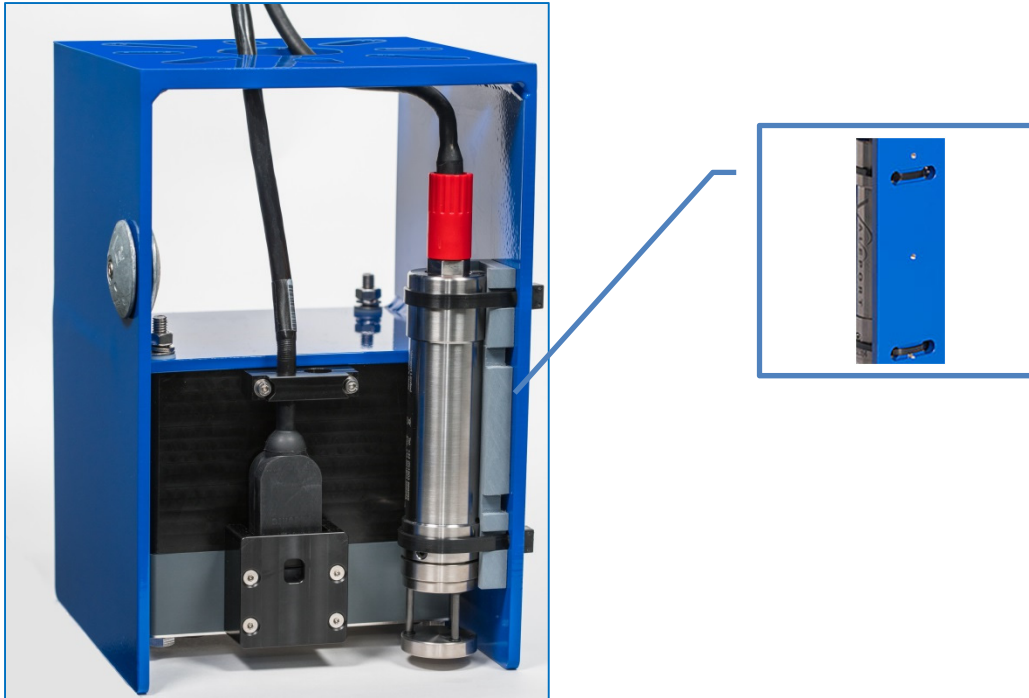

Figure 7: Sonic 2020 deck lead connection and SV probe are aft

3.1.2 Sonar Deck lead

At the current time, R2Sonic offers two different diameter deck leads; both types can be used with the Sonic 2020. The Sonic 2020 standard cable diameter is 10.2mm (0.40 inches); the Sonic 2024/2022 standard cable diameter is 14.2mm (0.56 inches). The Sonic 2020 cable clamp can accommodate both cables; orientate the clamp so that the correct diameter is used to secure the cable. The cable clamp is attached to the Sonic 2020 housing via two M4 fasteners, as seen in the above illustration. Remove the clamp prior to running the cable; orientate and attach the clamp after the cable has been seated.

If the cable is to be run through the hydrophone pole, pass the cable through the large centre opening on the flange plate. Holding the moulded end of the deck lead, gently rock the connector left to right, whilst pushing down, until it is fully seated. The seating is visible in the observation window.

A light spray of silicone lubricant (3M Silicone Lubricant, **3M ID:** 62-4678-4930-3) will aid in seating the connectors. **Silicone grease is never to be used.**

3.1.3 Sound velocity probe deck lead

If the sound velocity probe's deck lead is to be run through the hydrophone pole, pass it through the large centre opening, in the flange plate, and attach the connector to the probe.

Do not pass the cable through the flange plate bolt openings.

Version	3.3	Rev	r000
Date	13-04-2017		



Figure 8: R2C 2020 Mounting Frame

Sound velocity probe is contained within the fairing

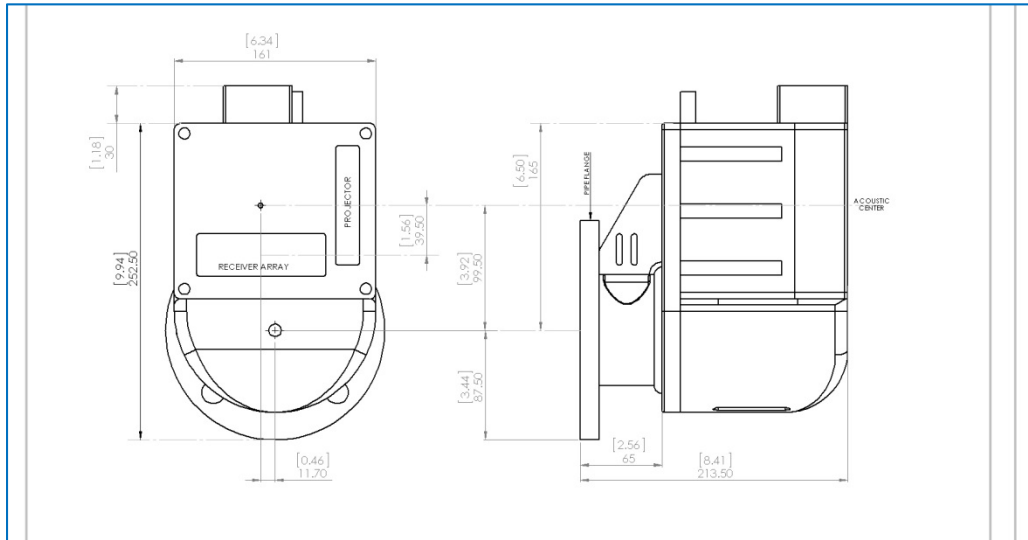

Figure 9: R2C Mounting frame drawing

Centre of R2C Flange to alongship reference = 0.0995m (0.326 survey feet) aft

Top of R2C Flange to Z reference = 0.2135m (0.700 survey feet)

Version	3.3	Rev	r000
Date	13-04-2017		

Part No. 96000005

WARNING – Pre-Deployment Test Mode

The Sonic family of multibeam echosounders is designed to be operated whilst deployed in water (fresh or sea) and should not be operated in air except for brief periods for the deck test detailed within this manual. The sonars use water as a means to dissipate heat. Operating the sonar, in air, can do damage to the sonar; to prevent damage, R2Sonic now has a pre-deployment test mode.

To avoid damage to the sonar, the sonar will sense when it is being operated in air and will reduce power. The sonar will determine, from the sound velocity input, whether it is immersed in water or operating in air.

The sonar allows full Tx Power if either of the following conditions is true:

1. The operator selects manual sound velocity.
2. The SVP reported 1300 to 1600 m/sec somewhere within the past 30 seconds

Otherwise it limits the requested Tx Power. The GUI will recognize this and flag the power setting with a red indicator light to alert the user.

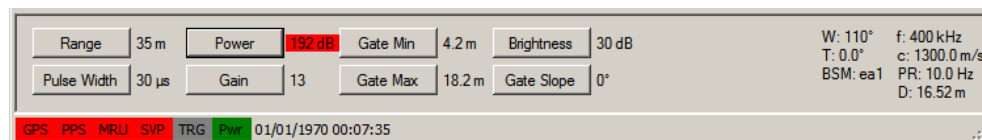

Version	3.3	Rev	r000
Date	13-04-2017		

3.2 Deck Test Prior to Deployment

It is highly recommended that the operation of the sonar be verified prior to putting the sonar or vessel into the water. The deck test will test both the receiver and the transmitter.

3.2.1 Communications test

The first test is to ensure that computer, running Sonic Control, can communicate with both the sonar head and the SIM.

- Make sure that Sonic Control is installed in the root directory on the computer and not under ProgramFiles nor on the desktop
- Make sure all firewalls are off
- Make sure all virus checkers are disabled
- Verify the IP4 configuration for the network card being used for the sonar
- Make sure that the files, in the Sonic Control directory, are not Read-only, or otherwise protected by the operating system

3.2.2 Receiver rub test

This tests the receiver and the receive elements

- Turn transmit power off by positioning the cursor over the Power button, then Shift + left mouse button; this will set transmit power to 0
- Reduce the range to 30 metres
- Turn Acoustic Imagery on (under Settings | Displays)
- Increase Gain to 30
- Have someone rub the receiver face, slowly, with their fingers, along the face of the receiver. Noise will be seen, in the display, that will correspond to the rubbing
- If noise is not seen, try adjusting range or gain
- If noise is not seen, check the decklead connector, on the receiver

3.2.3 Problems with Deck Test

If there are any issues, with the Deck Test, please contact R2Sonic Support immediately. R2Sonic Support can be contacted via email: R2Support@R2Sonic.com; telephone/SMS: +1.805.259.8142; Skype: chaswbrennan

Version	3.3	Rev	r000
Date	13-04-2017		

3.3 Sonar Head Installation Guidelines

3.3.1 Introduction

The proper installation of the Sonic 2020 sonar head is critical to the quality of data that will be realised from the system. No matter the type of installation (hull mount, moon pool, or over-the-side pole), the head must be in an area of laminar flow over the array. Any vibration or movement of the sonar head, independent of vessel motion, will result in reduced swath coverage and noise in the data. To this end, the head must be installed on as sturdy a mounting arrangement as possible; fore and aft guys are NOT recommended as a means to obtain this stability.

The initial investigation of where to mount the sonar head should take into account any engines, pumps, or other mechanical equipment that may not be operating at the time, but may be a cause of vibration or noise when operating under normal survey conditions.

The structural stability of any decks, bulkheads, or superstructure, which will be employed when mounting the sonar head, must be taken into account and strengthened if necessary.

3.3.2 Over-the-Side mount

The over-the-side mount is normally employed for shallow water survey vessels and/or temporary survey requirements. The over-the-side mount consists of a frame structure that is attached to the vessel's hull or superstructure. A pole will be attached to the frame, normally through the use of swivel flanges, flanges, or other means by which the head can be swung up when not in use and deployed when needed. A similar mounting arrangement is the bow – mount, which is specialised form of an over-the-side mount.

In order to ensure stability of the pole, it should have a securing arrangement as close to the water line as possible. As stated above, the use of fore or aft guy wires is strongly discouraged.

When the pole is in the 'up' position it should be secured so that there is no or little movement that would be a strain on the flanges or mount. The head should be washed with fresh water as soon as possible and inspected for any damage or marine growth. If the head is to remain in the 'up' position; a covering should be put over the head that will protect it from the sun.



Figure 10: Typical over-the-side mount

Version	3.3	Rev	r000
Date	13-04-2017		

3.3.3 Moon Pool Mount

Deploying the sonar head through a moon pool is usually a more stable mounting arrangement than an over-the-side pole. A moon pool is an area, within a vessel, that is open to the water. The sonar head is normally mounted in such a way that it can be deployed and recovered through the moon pool. The pole or structure that the sonar head is mounted on is normally shorter and sturdier than an over-the-side mount; this can allow for higher survey speeds.

3.3.4 Hull Mount

The hull mount is the sturdiest of all possible ways to mount a sonar head. With a hull mount, the sonar head is physically attached to the vessel’s hull or within the hull. With this way of securing the sonar head, there is no possibility of movement, outside that of the movement of the vessel.

There are disadvantages to the hull mount: the head cannot be inspected easily for marine growth or damage; the vessel may be restricted in the depth of waters that can be surveyed, due to the head being permanently attached to the hull.

A normal hull mount will also involve the fabrication of a fairing, on the hull, to ensure correct flow patterns over the sonar head.

3.3.5 ROV Mounting

The Sonic 2020 is ideal for undersea operations due to its compact size and low power consumption. With all processing being done in the Receive Module, all that is required is to provide Ethernet over single mode fibre optic communication, between the SIM and the Receive Module. The 48VDC is supplied via the ROV’s own power distribution.

Please refer to [Appendix VII](#) for full details on ROV and AUV installation, interfacing and operation.

Version	3.3	Rev	r000
Date	13-04-2017		

4 SONIC 2020 SONAR INTERFACE MODULE (SIM) INSTALLATION and INTERFACING

4.1 Sonar Interface Module (SIM)¹



Figure 11: Sonar Interface Module (SIM)

The Sonar Interface Module is the communication centre for the Sonic 2020 multibeam system. The SIM receives commands from Sonic Control 2000 and passes the commands to the sonar head. The SIM also receives the PPS and timing information, which is transferred to the sonar head to accurately time stamp all bathymetry data in the sonar head. The data, from the sonar head, passes through the SIM's Gigabit switch and onto the data collection computer. Sound velocity, from the probe located near the sonar head, and motion data are also interfaced to the SIM to be passed onto the sonar head. The SIM is interchangeable; it is not tied to a unique sonar head.

4.1.1 Physical installation

The 15 metre cable, from the Sonic 2020 Receive Module, connects directly to the SIM via an Amphenol™ style connector. Therefore, the SIM must be located within 15 metres of the sonar head (a 50 metre cable is an option). The SIM is not water or splash proof, so it must be installed in a dry, temperature- controlled environment.

The SIM is small and light enough so as to be unobtrusive, but care needs to be taken that it is secured in such a manner so that it will not fall or move whilst the vessel is at sea. The SIM can be secured to a surface (horizontal or vertical) through the pass-through holes that are under the corner trim pieces. The holes accept: #8-32 pan head, M4 pan head or M5 socket head cap screws. The trim piece can be removed by hand to expose the securing holes.

¹ For the I2NS SIM, please refer to [Appendix I](#)

Version	3.3	Rev	r000
Date	13-04-2017		



Figure 12: Removal of trim to expose securing holes

4.1.2 Electrical and Interfacing

The SIM has four DB-9 male connectors on the front. The label, on the top, clearly shows all connections. Beginning on the left front, the connections are: GPS, Motion, Heading, and Sound Velocity. At present time the GPS time message (for time stamping), sound velocity, and motion (for roll stabilisation) inputs are enabled. Next to each DB-9 are two vertical LEDs; the top LED responds to the input data: Green – receiving data that is being decoded; Red – no connection; Orange – receiving data that cannot be decoded (wrong baud rate or format setting in the Sonic Control Sensor Settings menu). There is also a LED next to the on/off rocker switch, which is the head connection indicator: Green – head on, Red – head power off or not connected, Orange – problems with communications or if the sonar head current draw is below expected limits.

On the second row up are three BNC connections as well as three Ethernet connections. The BNC, which is above the GPS DB-9, receives the one Pulse Per Second (PPS is for clock synchronisation) from the GPS receiver. The PPS, along with the GPS time information on the DB-9, is used to time stamp and synchronise all data.

The two BNC connections, to the right of the Ethernet connectors, are used to receive and send synchronisation triggers to and from other systems.

Mains voltage (90 – 260VAC) is input via the IEC connector. Above the connector is a rocker switch which turns on the system.

The SIM outputs the data (from the sonar head), via Ethernet, on any of the three RJ45 connections. The front panel RJ45 jacks are routed to the SIM’s internal Gigabit Ethernet switch. The Gigabit switch is self-sensing; Ethernet cross-over cables are not required.

Version	3.3	Rev	r000
Date	13-04-2017		



Figure 13: SIM Interfacing Physical Connections

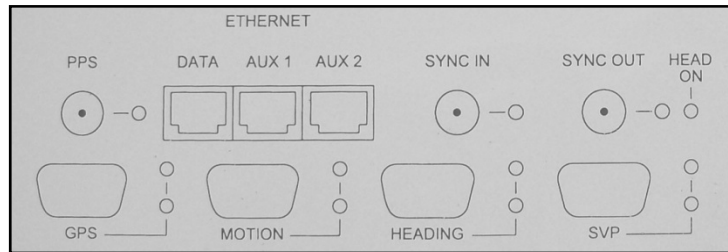

Figure 14: SIM Interfacing Guide (from label on top of the SIM)

NB. Again, at the present time, the SIM only takes in the PPS, NMEA Time message, sound velocity and motion data and not heading information.

Version	3.3	Rev	r000
Date	13-04-2017		

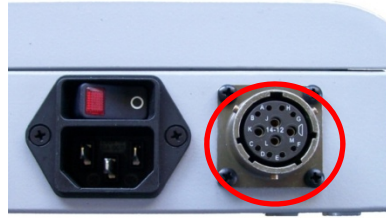

Figure 15: SIM IEC mains connection and deck lead Amphenol connector

Figure 16: Wet end connector

Function	Wet End Pin Number	Amphenol MS Pin Number	R2Sonic 10013A Wire Colour	CAT 5
BI_DC+	4	A	Blue	Blue
BI_DC-	5	B	Black paired with Blue	Blue/White
BI_DB-	7	C	Green	Green
BI_DB+	8	D	Black paired with Green	Green/White
BI_DD-	11	E	Brown	Brown
BI_DD+	12	F	Black paired with Brown	Brown/White
BI_DA-	9	G	Orange	Orange
BI_DA+	10	H	Black paired with Orange	Orange/White
Data Shield	6	n/c	Drain Wire	
Power +	1	J,M	Orange, Yellow (#18AWG)	
Power Return	2	K,L	Black, Blue (#18 AWG)	

Table 6: Deck Lead Pin Assignment (Gigabit Ethernet and Power)

4.1.3 Serial Communication

All serial interfacing is standard RS-232 protocol.

Pin	Data
2	Receive
3	Transmit
5	Ground

Table 7: DB-9M RS-232 Standard Protocol

Pin	Data	Function
1	Receive ²	Secondary Serial Port
2	Receive	Primary Serial Input
3	Transmit	Primary Serial Output
4	+12VDC	+12VDC Power
5	Ground	Data and Power Common
6	N/C	Not Connected
7	+12VDC	+12VDC Power
8	N/C	Not Connected
9	Transmit ²	Secondary Serial Output

Table 8: SIM DB-9M Serial pin assignment

4.1.4 Time and PPS input

4.1.4.1 Connecting PPS and Time to the SIM

In order to provide the most accurate multibeam data possible, the Sonic 2020 requires the GPS Pulse Per Second (PPS) and NMEA ZDA time message or an ASCII UTC message, which is associated with the pulse, to accurately time stamp the Sonic 2020 data. The data collection software may take in the same PPS and time message to synchronise the computer clock and the auxiliary sensor data.

The PPS is a TTL (transistor – transistor logic) pulse. The SIM box PPS input threshold is $\approx +1.35V$ with about 0.14V of hysteresis. The PPS input rejects pulses narrower than about a microsecond to reject high frequency cable reflections and ringing, but not all types of noise. The input pulse timing needs to be stable, within about 100ppm, or the SIM box will reject the pulses and the LED will flash red instead of green. The pulse is transmitted to the SIM and the data collection computer via a coaxial cable (such as RG-58); the cable is terminated with BNC connectors so that it is easy to use a ‘T’ adaptor to parallel the PPS to different locations. Connect one end of the coaxial cable to the GPS receiver’s PPS output (via a ‘T’ adaptor, if required) and the other end to the SIM BNC labelled PPS. When a pulse is received, the LED next to the BNC connector will flash green at 1 Hz.

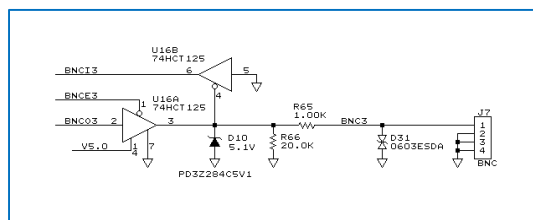

D31 provides ESD (electrostatic discharge) protection; it trips at about +/- 35V

Figure 17: TTL input/output (PPS and Sync In/Out) schematic

Version	3.3	Rev	r000
Date	13-04-2017		

The standard time message is a NMEA sentence identified as \$GPZDA and is expected to arrive after the PPS. The time message will also, usually, go to the data collection computer, so the ZDA message must either be split or output on two of the GPS receiver's RS-232 ports. The \$GPZDA and UTC message can be input to the SIM either via serial or Ethernet.

4.1.4.2 Trimble UTC: UTC yy.mm.dd hh:mm:ss ab<CR><LF>"

Trimble GPS receivers provide the PPS time synchronisation message with an ASCII UTC string and not the ZDA string. The SIM expects the UTC to arrive 0.5 seconds before the PPS. When interfacing a Trimble GPS, use the UTC message and not the ZDA for timing information. If both the ZDA and UTC are input, the UTC will take priority; the SIM will automatically ignore ZDA while receiving UTC. The UTC status code ('ab') is ignored.

Setting up the time synchronisation is done through the Sonic Control software detailed in [Section 5.4](#)

In that each of the SIM serial ports provides 12VDC on selected pins, it is not recommended to use a fully wired serial interface cable as this may cause some GPS receivers to stop sending data. Use a cable with only pins 2, 3 and 5 wired, if possible.

4.1.5 Motion Input

The roll component, of the motion data, is used for roll and pitch stabilisation.

Supported formats and connection are:

- TSS1 Serial or Ethernet
- IXSea TAH Serial or Ethernet UDP (\$PHOCT)
- MiniPOS3 Serial or Ethernet

When using serial communication, it is recommended to set the motion sensor to output the highest baud rate and highest update rate possible, preferably 100 Hz or higher

Connect the motion data to the DB-9 labelled Motion, on the SIM, or via Ethernet input to one of the RJ45 AUX receptacles. Setting up the serial port or Ethernet parameters is done through Sonic Control, which is covered in [Section 5.4](#).

4.1.6 SVP input

4.1.6.1 Connecting the sound velocity probe

The sound velocity probe is used to provide the sound velocity at the sonar head, which is used for the receive beam steering. It is not used for refraction correction; that must be accomplished in the data collection software employing a full water depth sound velocity cast.

4.1.6.2 Valeport miniSVS

The miniSVS comes with a 15 metre cable. The cable carries both the DC power (8 – 29V DC) to the probe and the data from the probe to the SIM. The miniSVS is set for a baud rate of 9600 and will

Version	3.3	Rev	r000
Date	13-04-2017		

start outputting sound velocity (Format: <sp> xxxx.xxx m/sec) as soon as power is applied. The miniSVS cable is terminated with a female DB-9 RS-232 connector; this is attached to the male DB-9 RS-232 connector, on the SIM, marked SVP. The probe is powered through the SIM's serial port 12VDC supply.

Setting up the SVP input is done through the Sonic Control software detailed in Section 5.4.

4.1.6.3 Other supported sound velocity formats

The SIM can also accept sound velocity in the below listed formats. Velocity (V) is parsed out of the messages and all other values are ignored.

SeaBird: "TTT.TTTT,CC.CCCCC,SSSS.SSSS, VVVV.VVV (CR/LF)"	(39 chars)
SeaBird + P:"TTT.TTTT,CC.CCCCC,PPPPP.PPP,SSSS.SSSS, VVVV.VVV (CR/LF)"	(49 chars)
SVP-C: "VVVVVDDDDTTTBBCCCC (CR/LF)"	(21 chars)
SmartSV: " VVVV.VV (CR/LF)"	(11 chars)

The last format ("VVVV.VV) is also accepted with a flexible width.

There is no setup to accept these other formats, merely set the baud rate and the SIM will automatically parse the sound velocity.

Version	3.3	Rev	r000
Date	13-04-2017		

Version	3.3	Rev	r000
Date	13-04-2017		

Part No. 96000005

5 OPERATION OF THE SONIC 2020 VIA SONIC CONTROL

The Sonic 2020 multibeam echosounders are controlled by the Sonic Control software. The Sonic Control GUI does not require a dedicated computer and is usually installed on the user's data collection computer. The Sonic 2020 requires the 22 Mar 2013 GUI, or any later version; it is not compatible with GUI versions prior to the 22 Mar 2013 release.

5.1 Installing Sonic Control Graphical User Interface

Sonic Control is supplied on a CD or as an attached file. There is no installation program, merely decompress the program to a folder in a root directory of the computer. Send the R2Sonic.exe to the desktop as a short cut (right click on R2Sonic.exe and choose Send to -> Desktop (create shortcut)). The computer must have the Windows .NET Framework installed. This can be downloaded, for free, from the Microsoft web site (dotnetfix35.exe). **NB. Do not install Sonic Control under Windows' Program Files or put all files on the Desktop.**



Figure 18: Sonic Control Icon on desktop

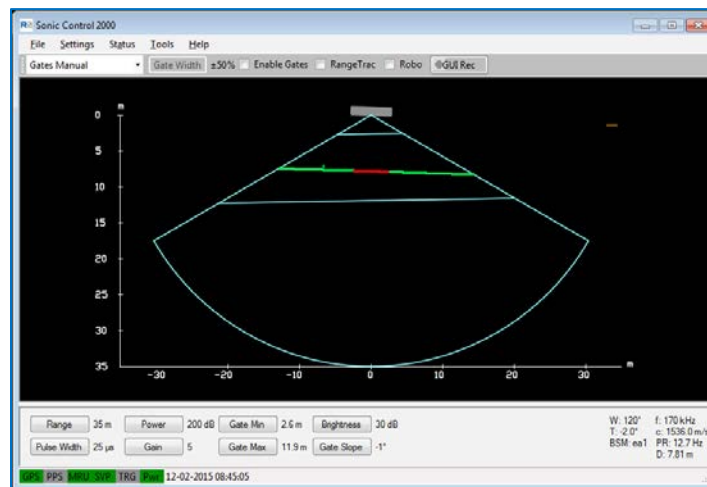

Figure 19: Sonic Control 2000

5.2 Hot Keys

- F2 – Brings up the Sonar Settings
- F3 – Brings up the Sonic 2020 FLS settings
- Alt+Z – Returns sector to 0 rotation
- Alt+X – Takes a snapshot of the GUI
- Alt+I – Display INS Monitor

Version	3.3	Rev	r000
Date	13-04-2017		

5.3 Settings Menu

The Settings Menu provides access to the sonar setup and configuration. Each selection will be detailed. The order of the menu selections is not the order of setup. The initial sonar setup involves establishing communications between the sonar head, Sonic Control and the SIM.

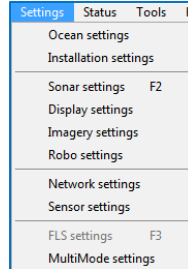

Figure 20: Settings Menu

5.4 Network Setup

All communication, between the Sonic 2020 and the SIM and data collection computer is via Ethernet. The first step in setting up the sonar system is to establish the correct Ethernet parameters, which include the IP (Internet Protocol), Subnet Mask and UDP (User Datagram Protocol) base port under Settings | Network settings.

5.4.1 Initial Computer setup for Communication

Prior to starting Sonic Control 2000 for the first time, the computer’s network parameters must be set correctly to establish the first communication.

Open the computer’s network connections. Identify the NIC (Network Interface Card) that is being used for the Sonic system and select Properties (usually by using the right mouse button context menu, highlight the Internet Protocol (TCP/IP) and select properties. Select ‘**Use the following IP address**’ and enter:

IP address: 10.0.1.102

Subnet mask: 255.0.0.0

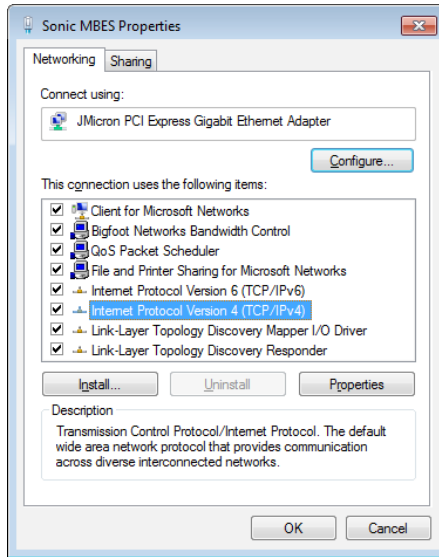

Figure 21: Windows Internet Adaptor Properties

Select Internet Protocol and then select Properties to enter the correct IP and Subnet mask.

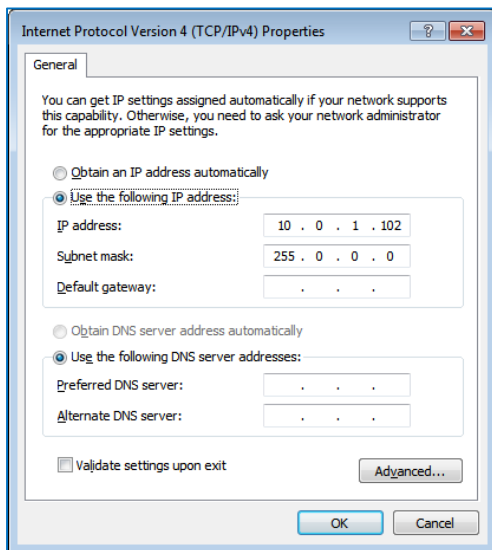

Figure 22: IP and Subnet mask setup

It is very important that the exact settings, as shown in adjacent image, are entered. This will allow initial communications to be established with the Sonic system; once communication is established, the IP address can be user configured.

WARNING

**ALL COMPUTER
FIREWALLS MUST BE
DISABLED TO INSURE
COMMUNICATION.**

5.4.2 Discover Function

The sonar head and the SIM have initial IP and UDP ports to establish communication (see below). **Communication will not be established until the serial number of sonar head and the SIM are entered in the settings for Sonar 1, in the Sonic Control 2000 Network settings.**

Version	3.3	Rev	r000
Date	13-04-2017		

Use the Discover function to request the serial number information from all attached R2Sonic equipment. The Discover function will automatically transfer the serial numbers to the correct field.

5.4.2.1 Default Network Configuration

Head IP:	10.0.0.86	BasePort:	65500
SIM:	10.0.0.99	BasePort:	65500
GUI:	10.0.1.102	BasePort:	65500
Bathy:	10.0.1.102	BasePort:	4000 (actual port 4000)
Snippets:	10.0.1.102	BasePort:	4000 (actual port 4006)
TruePix™:	10.0.1.102	BasePort:	4000 (actual port 4001)
Water Column:	10.0.1.102	BasePort:	4000 (actual port 4005)
INS:	10.0.0.44	BasePort:	No BasePort – Does not apply

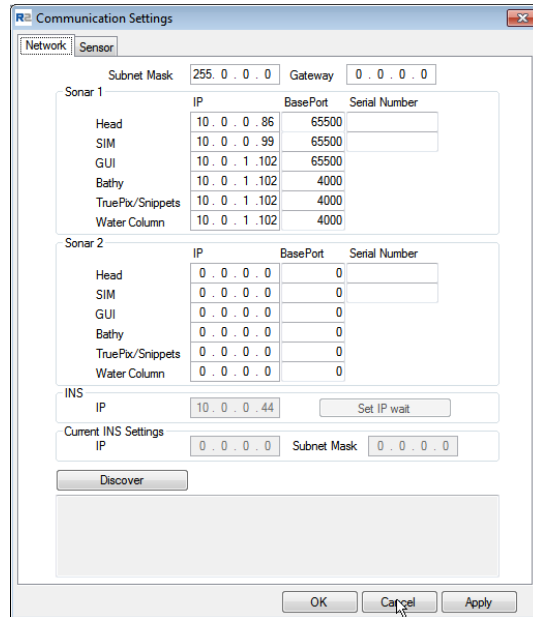

Figure 23: Sonic Control Network setup

Until the correct serial numbers are entered, there will be no communication. Once the correct serial numbers are entered, click **Apply** and dots will be visible in the wedge display signifying communication is established. Using Discover will guarantee that the serial numbers will be entered correctly and verify Ethernet communication between devices.

5.4.2.2 INS Addressing

When using the I2NS system, the INS default IP is 10.0.0.44. Initially, the INS will not be ready to receive an IP address. The 'Set IP' becomes active when the INS is ready to accept an IP (after one to two minutes). When the time period, to set the IP address is over, the button changes to 'Set IP Expired'.

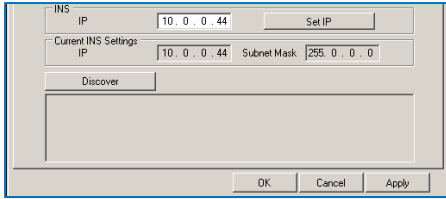

Figure 24: Set INS IP

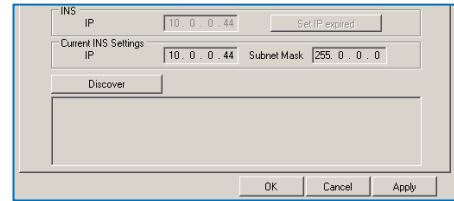

Figure 25: Set IP Time Expired

5.4.2.1 Network Broadcast to more than one computer

It is possible to send the bathymetry, TruePix and Water Column data to more than one computer via a broadcast. The Subnet Mask will dictate the correct IP address to be used to broadcast. Using the default Subnet Mask of 255.0.0.0, the Bathy, TruePix and Water Column IP would be 10.255.255.255. If the user sets a Subnet Mask of 255.255.0.0 the output IP would be 10.0.255.255.

5.4.3 Configuring Network Communication

- The network settings allow freedom in selecting IP numbers for various pieces of equipment.
- The most important settings to get right are the Subnet Mask (upper left corner of the Network settings dialog) and the GUI IP number. If these numbers are wrong, the Sonic Control program will not be able to configure the sonar head and SIM. The GUI IP number and subnet mask, entered in the Network Settings dialog, is the IP address and subnet mask assigned to the computer that is running the Sonic Control program.
- To verify computer network setup run **ipconfig/all** from the command line or command prompt.

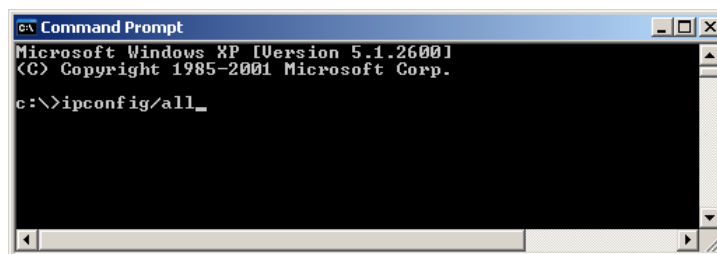

Figure 26: Command prompt-ipconfig/all

- The Sonic Control program is required to send networking configuration to the sonar head and SIM whenever the sonar head and/or SIM are powered up.
- If the GUI IP number and subnet mask are set correctly, the Discover button will list the R2Sonic devices attached to the network. If the GUI IP number and/or subnet mask is set wrong, Discover will not work and the sonar head and SIM will not configure.

Version	3.3	Rev	r000
Date	13-04-2017		

- Settings for Sonar 1:

Head IP: Any unique IP number within the network subnet.

Head BasePort: Any number between 49152 and 65535. Preferred is: 65500.

SIM IP: Any unique IP number within the network subnet.

SIM BasePort: Any number between 49152 and 65535. Preferred is: 65500.

GUI IP: Same IP number of the computer running the Sonic Control software.

GUI BasePort: Any number between 49152 and 65535. Preferred is: 65500.

Bathy IP: IP number of the computer running bathymetry data collection software.

Bathy BasePort: Base port number that the bathymetry data collection software requires.

TruePix™/Snippets IP: IP number of the computer running snippets data collection software.

TruePix™/Snippets BasePort: Base port number for Snippets, Snippets will be output on a port, which is the base port plus 6. With a base port of 4000, Snippets will be on port 4006; TruePix™ will be on port 4001

Water Column IP: IP address of the computer to receive water column data

Water Column BasePort: Base port number for Water Column data; Water Column data will be output on the base port plus 5. The default base port is 4000; Water Column data will be on port 4005.

- Settings for Sonar 2:

All entries must be zero. Serial numbers are left blank.

- Once networking is set up, Sonic Control will automatically connect upon power up; there is no need to go back into the Network Settings

Version	3.3	Rev	r000
Date	13-04-2017		

5.5 Sensor Setup (Serial Interfacing)

The Sonar system receives various data, on the SIM serial ports, as noted in Section 5. Select **Settings | Sensor** setting to setup the serial communications parameters.

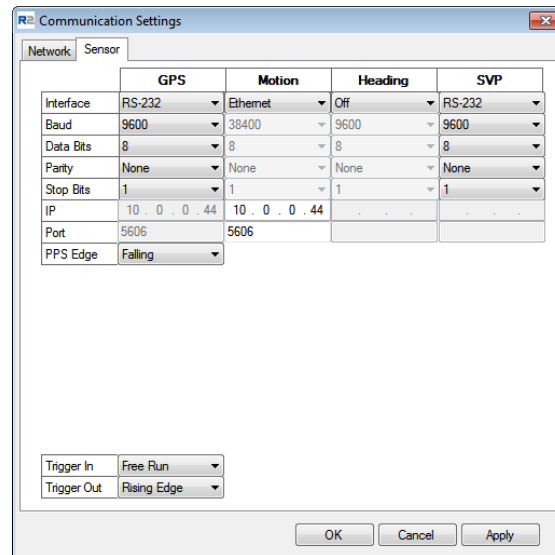

Figure 27: Sensor communication settings

5.5.1 Ethernet Interfacing

The system will accept the GPS time message, Motion and SVP over Ethernet as well as the normal serial connection. When setting up the Ethernet interfacing, the IP and Subnet Mask settings, for the auxiliary sensor, must agree with the sonar's Ethernet configuration. The data must also utilise UDP. The same UDP port can be used for all inputs, but separate UDP ports is suggested. Enter the sending sensor's IP.

In the dropdown for Interface, select Ethernet. When selected, the IP and Port fields will become active. Set an IP that agrees with the rules of the subnet mask (default subnet is 255.0.0.0) and the UDP port. The LED's, on the SIM, will turn green when data is received the same as with serial data.

Using the default sonar Ethernet configuration, with a Subnet mask of 255.0.0.0 and the sonar's IP set to 10.xxx.xxx.xxx, the auxiliary sensor's network configuration has to be set up with the same Subnet mask (255.0.0.0) and use similar IP addressing (10.xxx.xxx.xxx). The illustration, below, shows IP addressing based on the default sonar network configuration.

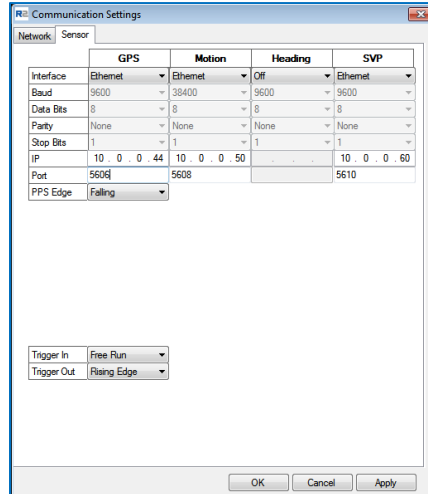

Figure 28: Sensor Ethernet communications settings

5.5.2 GPS

The GPS input is for the ZDA time message (\$GPZDA) or Trimble UTC message, other NMEA messages may be in the same string; it is not necessary to isolate the ZDA or UTC. In the GPS receiver's operation manual, there will be an entry that will detail which edge of the PPS pulse is used for synchronisation; this will be either synch on rising edge, or synch on falling edge. Selecting the correct polarity is vital for correct timing.

The firmware supports the ZDA integer part (HHMMSS) and accepts PPS pulses if they pass a basic stability test: the last two pulses must be within 200ppm. If the PPS is unstable or absent, the SIM's internal trained clock-runs with a high degree of accuracy.

The decoded time, from the bathymetry packet, is visible in the main display on the lower left along with the cursor position information. If the displayed time is 01/01/1970 it indicates that timing is not set up correctly.

5.5.3 Motion

The motion data is used for roll and pitch stabilisation. There are three accepted formats: TSS1, iXSea \$PHOCT or CDL's MiniPOS3. All formats are accepted on serial or Ethernet.

The motion data should be at the highest possible baud rate, with the motion sensor configured for the highest output possible; at a minimum 100Hz update.

5.5.4 Heading

Not currently enabled.

5.5.5 SVP

This is used to set the communication for the sound velocity probe mounted on the sonar head.

5.5.6 Trigger In / Trigger out

Used to receive or send synchronisation TTL pulses. Output goes high when transmitter pings, goes low after receiver has collected data.



Figure 29: Trigger In/Out Options

5.5.6.1 Trigger In

- The SIM Trigger In input requires a TTL signal (0 to +5V)
- The minimum high level trigger point is +2.4V
- The trigger pulse width must be longer than 1µsec
- The sonar will ping 10.025msecs (±10µsecs) after receiving the trigger

5.5.6.2 Trigger Out

- Output is 0 to +5V
- If Trigger Out is set to Rising Edge, the output pulse is high during the receive cycle. If Trigger Out is set to Falling Edge, the output pulse is low during the receive cycle.

In the lower portion, of the GUI, the colour indicator will indicate when the Trigger In is active by turning from grey to green **TRG Pwr**. When the Trigger In mode is set to Manual, the colour indicator will change to yellow **TRG Pwr**. Manual mode allows the sonar to ping every time an external Ethernet command (PNGØ, 1) is received or, if in FLS mode, the Ping button is used.

5.6 Sonar Settings (Hotkey: F2)

The Sonic 2020 has many features that provide the user with the versatility to tailor the system to any survey project; many of these features can be controlled either through the Operation Settings or with the mouse cursor.

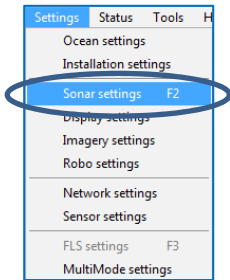

Figure 30: Settings Menu

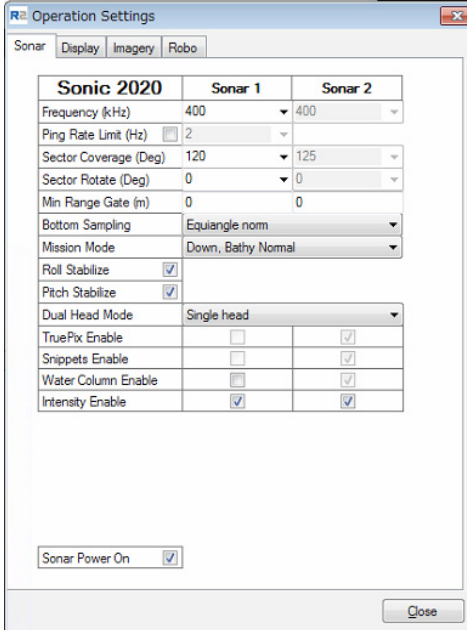

Figure 31: Sonar Operation Settings window

5.6.1 Frequency (kHz)

The Sonic 2020 operates on a user selectable frequency, from 200 kHz to 400 kHz, in 10 kHz steps. The operating frequency can be changed on the fly; there is no need to stop recording data, go offline, or load any firmware. The operating frequency is selected via the drop down menu next to Frequency (kHz) or can be typed in (within the 200 kHz to 400 kHz restrictions).

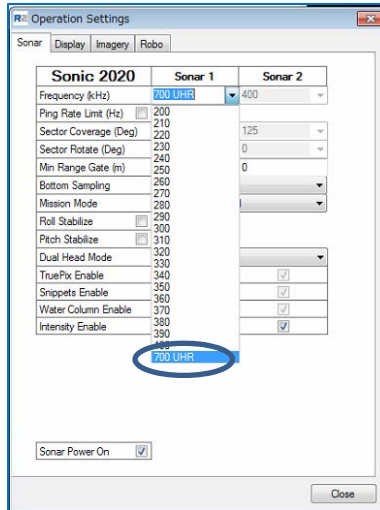

Figure 32: Operating Frequency Selection

5.6.2 700 kHz UHR (Optional)

The optional UHR upgrade enables the sonar to operate at 700 kHz for Ultra High Resolution. If this option is installed, there will be the added 700 kHz frequency, after 400, in the available frequency list (as seen above). If the upgrade is not installed there will be no listing of this frequency.

When 700 kHz is selected, the swath sector will automatically be reduced to 70°. The UHR upgrade is intended for short range operation. In the UHR mode of operation, the across track beamwidth is 1.0° and the along track beamwidth is 1.0°: true Ultra High Resolution sonar.

5.6.3 UHR Operation Suggestions

When operating at the high 700 kHz frequency it will be necessary to increase Power and Absorption significantly (Absorption set to 200dB/km). Along with this will be a possible increase in Pulse Length, Gain and Spreading Loss. As frequency increases so does the effect of attenuation and this is why, when in UHR mode, the sonar operating settings need to be increased to increase the total power going into the water and the higher gain needed to receive the attenuated signal. As stated the UHR mode is for short range operation.

5.6.4 Ping Rate Limit

The Sonic 2020 can transmit at a rate up to 60 Hz (60 pings per second), this is called the Ping Rate. At times, it may be desirable to reduce the ping rate to reduce the collection software file size or for other reasons. Highlight the box next to Ping Rate Limit and the ping rate limit drop down box will be activated; select a predefined ping rate or enter a manual rate.

Version	3.3	Rev	r000
Date	13-04-2017		

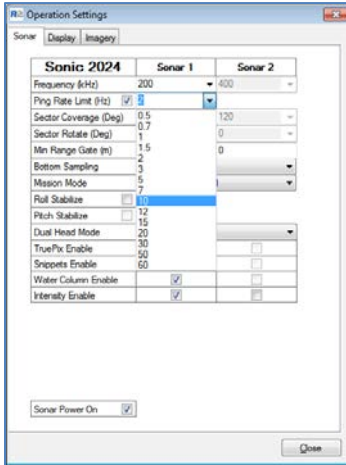

Figure 33: Ping Rate Limit

5.6.5 Sector Coverage

The Sonic 2020 allows the user to select the swath sector from 10° to 130°, with an option to increase the sector to 160° (please contact R2Sonic for further details on this option). All 256 beams are used, no matter what the selected sector coverage that is chosen. The smaller the sector, the higher the sounding density is within that sector. Changing the Sector Coverage can be done on the fly, with no need to stop recording data or to go offline.

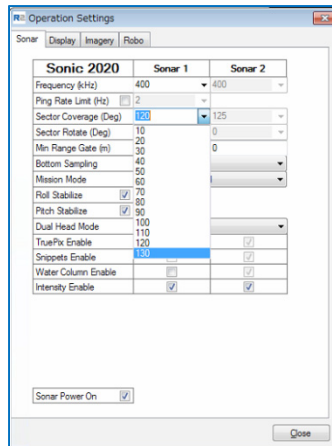

Figure 34: Sector Coverage

The Sector Coverage can also be controlled via the mouse cursor, inside the wedge display.

5.6.5.1 Symmetric sector sizing

Position the cursor on either of the straight sides of the wedge; the cursor will change to a double arrow and the sector can be reduced or increased. When using the cursor to change the sector coverage, the change only takes place when the mouse button is released. The sector will be

symmetrically set about nadir. The sector angle will be numerically visible in the lower left hand corner of the wedge display while the mouse button is depressed.

5.6.5.2 Asymmetric sector sizing

The Shift button can be used to only move one side of the wedge in and out. Position the cursor on either the right or left leg of the wedge. Hold down the keyboard Shift button and left mouse button (LMB) to only move that leg of the wedge. Asymmetrical sector sizing can only be done with the Shift and LMB; there is no menu selection for this type of sector sizing.

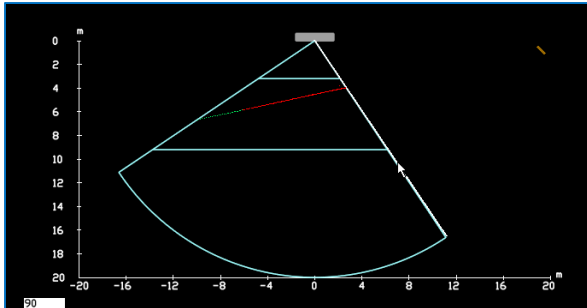

Figure 35: Asymmetric sector sizing

5.6.6 Sector Rotate

The Sonic 2020 has the capability to direct the selected sector to either port or starboard, allowing the user to map vertical features, or areas of interest, with a high concentration of soundings resulting from the compressed sector.

First, change the sector coverage to the desired opening angle; this will concentrate the 256 beams within the sector, and then increase the Range setting.

Second, rotate the swath towards the feature to be mapped with high definition. This is done on the fly, with no need to stop data recording or to go off line. When rotating, make sure to keep the bottom detections within the confines of the range.

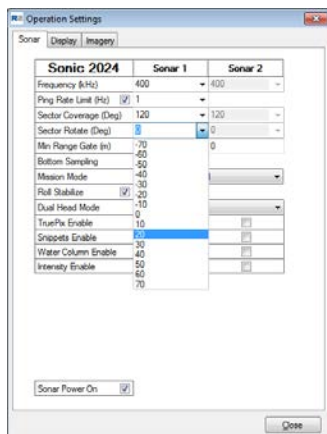

Figure 36: Sector Rotate

The sector can also be rotated using the mouse cursor, in the wedge display. Position the cursor on the curved bottom of the wedge; the cursor will change to a horizontal double arrow, the wedge can now be rotated to port or starboard. The angle of rotation is numerically visible in the lower left hand corner of the wedge display during rotation. A clockwise rotation is positive, an anti-clockwise rotation is negative.

The change only takes place when the mouse button is released. To return to a 0 rotation, use the Hotkey Alt+Z.

Version	3.3	Rev	r000
Date	13-04-2017		

5.6.7 Minimum Range Gate (m)

This provides a means to block out noise or interference close to the sonar head. Enter the range, in metres, from the sonar head to establish the gate; anything within that range will be blocked. As a safety precaution: **This gate should not be used when working in very shallow water.**

5.6.8 Bottom Sampling

There are two main options: Equiangular or Equidistant. The equiangular and equidistant modes are further enhanced by the Dual/Quad mode, described below. In equidistant mode, all beams are equally distributed, within the sector. There are limits to what the equidistant can do, based on opening angle and bottom topography; it is best on flat sea floor and with an opening angle (Sector Coverage) **equal to, or less than, 130°**. When in equidistant mode the conditions, such as excessive vessel roll, may cause the system to change from equidistant mode to equiangular mode; this is normal operation. The GUI will indicate that the system that is supposed to be in equidistant mode is now operating in equiangular mode by changing the BSM indicator to yellow.

A more technical way to look at this is the change over from equidistant to equiangular occurs when the outer beam grazing angle is 80° or greater. This is based on the below equation:

$$(\text{Swath Width} / 2) + \text{Head tilt} + \text{Sector rotate} = \text{grazing angle of outermost beam}$$

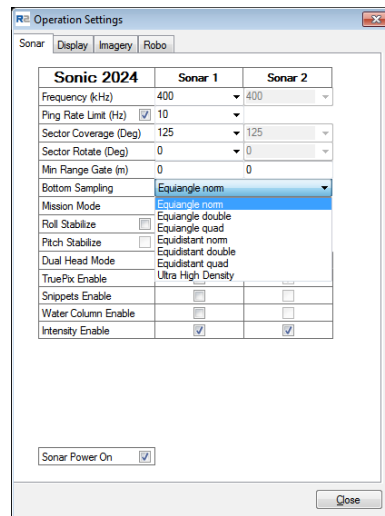

Figure 37: Bottom Sampling Modes

5.6.8.1 Dual/Quad Mode

The Dual/Quad bottom sampling modes can be used with both equiangular and equidistant sampling. The modes work by spatially distributing the across-track bottom sampling, ping by ping. The beam is slightly repositioned, in the across-track direction, with each ping. This mode was developed for ROV/AUV survey operations.

The Dual/Quad mode will work at all speeds; **however, it is at slower speeds, that the Dual or Quad modes will be more evident.**

$$\text{Beam Repositioning Angle} = [\text{SectorCoverage} / (256-1)] / n$$

Where:

- n = 1 for Normal Mode
- n = 2 for Double (or Dual) Mode
- n = 4 for Quad Mode

The Dual/Quad mode requires the 16-May-2013 head firmware and 17-Oct-2013 GUI or more recent. All firmware from Head\$16-may-2013-03-58-29, firmware will have this feature available. All GUIs, from 17Oct2013 and new will support the Dual/Quad mode.

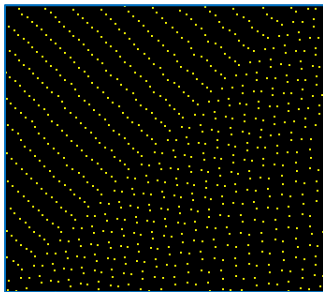

Figure 38: Example of going from normal to Quad mode

Version	3.3	Rev	r000
Date	13-04-2017		

5.6.8.2 Current Mode Display

The current Bottom Sampling Mode is shown in the main GUI window, in the lower right, information area. If operating in equidistant mode and conditions, such as heavy roll, force the system into equiangular mode, the BSM indicator will be highlighted in yellow to indicate that equidistant mode is temporarily suspended and the system is operating in equiangular mode. When conditions change, the operation will go back to equidistant mode automatically

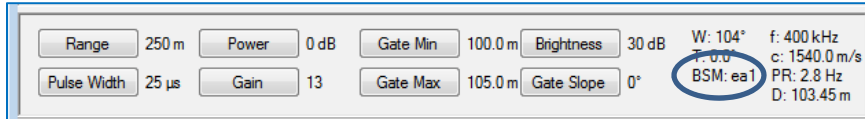

Figure 39: Indication of Bottom Sampling Mode

The BSM designations:

- ea1 = Equiangular normal
- ea2 = Equiangular dual
- ea4 = Equiangular quad
- ed1 = Equidistant normal
- ed2 = Equidistant dual
- ed4 = Equidistant quad

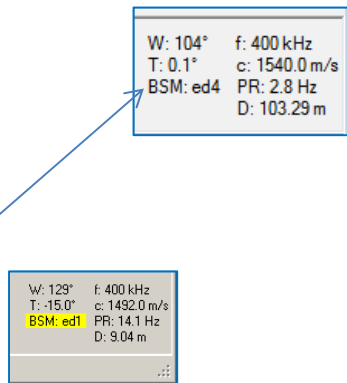
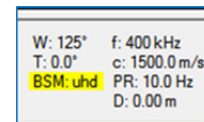

Figure 40: Highlighted indicator for equiangular operation

5.6.9 Ultra High Density (UHD™)

Introduced in 2017, the Ultra High Density mode is an entirely new technology developed by R2Sonic to provide the highest possible density of soundings in one ping: up to **1024 soundings per ping**. As opposed to producing pseudo beams by interpolating data to create the appearance of double the beams; R2Sonic searches across each beam footprint for additional soundings, using the extra-fine angular resolution that results from R2Sonic’s advanced signal processing to precisely locate each point. This provides much higher density and detail based on the acoustical properties of the bottom return acoustic signal = up to 1024 real bottom soundings.



When operating in UHD mode, the data collection software storage files can become large with the additional soundings and it is recommended to use the data collection software file splitting routines.

UHD uses equidistant spacing by default.

UHD mode is not currently recommended for mapping vertical surfaces.

Version	3.3	Rev	r000
Date	13-04-2017		

5.6.10 Mission Mode

The versatility, built into the Sonic 2020, is further enhanced with the ability to adapt the system to the nature of the survey task: normal survey or surveying a vertical feature. The Sonic 2020 can also be upgraded for Forward Looking Sonar (FLS) mode.

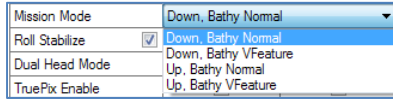
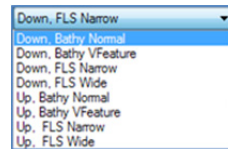

Figure 41: Normal Mission Mode selections

Figure 42: Mission Mode with the FLS Option Installed



- **Down, Bathy Norm:** Normal bathymetry survey
- **Down, Bathy VFeature:** With the ability to map vertical surfaces, without physically rotating the sonar head, this Mission Mode provides improved detection methods tailored to mapping vertical features. This specialised mode greatly reduces the corner ‘ringing’ seen in older technology systems. When using Bathy VFeature, please use Equiangular bottom sampling and not Equidistant.
- **Down, FLS Narrow/Wide:** One Forward Looking Sonar mode. No bathymetry output; this setting is for imagery only
- **Up, Bathy Norm; Up, Bathy VFeature:** is the same as the above, but orientates the wedge so it is pointing up (used primarily hull inspection type survey).
- **Up, FLS Narrow/Wide:** Most common setting when using the optional FLS feature

The Mission Mode can be changed on the fly, with no need to stop recording data.

5.6.11 Imagery

5.6.11.1 Acoustic Image (Display only)

The wedge can display acoustic intensity. This will aid in setting the correct combination of operating parameters (such as power, pulse width and gain). Enabling the Acoustic Intensity will increase the network load.

Enable the wedge Acoustic Intensity under the Display options. The Brightness control, in the main window, is used to set the intensity in the display. A good brightness setting, to start with, is 30dB. Most users also prefer the 1 pixel bathy dot option (on the Display tab), when viewing the Acoustic Image, in the display.

Version	3.3	Rev	r000
Date	13-04-2017		

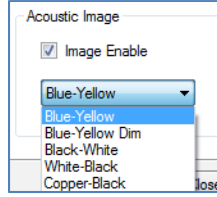

Figure 43: Enable Acoustic Image in the wedge display

5.6.11.2 Forward Looking Sonar

Forward looking mode can be in one of two configurations. FLS Wide and FLS Narrow. The Sonic 2020 changes the number of projector staves or elements employed for the FLS mode selected. FLS Wide uses a reduced number of staves, which results in 15° coverage at 400kHz, 18° coverage at 300kHz and 32° coverage at 200kHz. FLS Wide mode will reduce the source level below the normal 207dB maximum. FLS Narrow will use the entire projector.

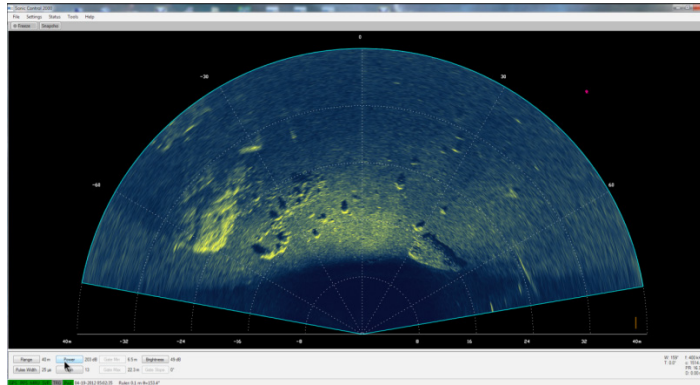

Figure 44: FLS Wide mode

5.6.11.2.1 FLS Mode adjustments

In FLS mode, the Brightness button adjusts the image 'gain' up to 80dB. The colour palette is selected in the Display options, under Acoustic Image.

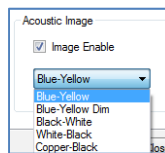

Figure 45: Imagery palette selection in Display Options

The FLS grid visibility is set in the Display | Grid settings. When in FLS mode, the range rings are turned on and off, by the Horizontal Grid Line selection. The angle markers (from nadir) are controlled by the Vertical Grid Line selection.

5.6.11.2.2 Stealth Mode

The FLS can be operated in a stealth mode, where the only time the system transmits is when the user manually triggers the sonar using the Ping button. In Sensor Settings, the 'Trigger In' option has

Version	3.3	Rev	r000
Date	13-04-2017		

to be put to Manual (the TRG indicator colour will change to Yellow), simultaneously, the Ping button will appear in the GUI. The only time an image will be updated, is when the user selects the Ping button.



Figure 46: Stealth mode single Ping button

5.6.11.2.3 Forward Looking Sonar

The Sonic 2020 has a steerable projector. Because of these advanced features, with the Sonic 2026 and Sonic 2020 FLS mode, there is an additional FLS option in the Settings menu that allows the user to set the Vertical Beamwidth and the degree of Vertical Steering.

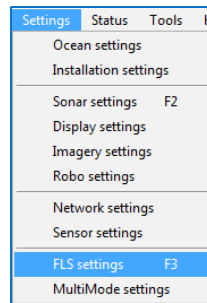

Figure 47: Settings menu FLS settings option

When FLS settings (or F3) is selected and one of the FLS options, in Mission Mode, is selected another window will be visible to select the beamwidth and steering angle.

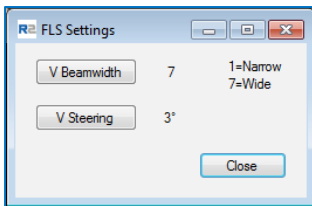

Figure 48: Sonic 2020/2026 FLS Options

The lower the frequency, the wider the vertical beamwidth and the greater the degree of vertical steering allowed. V Beamwidth and V Steering are used to alter the beamwidth and steering angle by using the left mouse button to decrease the value and the right mouse button to increase the value, up to the limits set by the operating frequency.

Approximate Vertical Beamwidth in Degrees

	200 kHz	250 kHz	300 kHz	350 kHz	400 kHz
Setting 1	8.7	6.9	5.8	5	4.3
Setting 2	11	8.7	7.2	6.2	5.4
Setting 3	12	10	8.3	7.1	6.2
Setting 4	15	12	9.7	8.3	7.3
Setting 5	18	14	12	10	8.7
Setting 6	22	18	15	13	11
Setting 7	30	24	20	17	15
Default	22	18	15	13	11



Table 9: Sonic 2020 FLS Vertical Beamwidth

As an example of the vertical steering: 400 kHz, the steering is $\pm 10^\circ$. At 200 kHz, the steering is $\pm 20^\circ$.

5.6.12 Roll Stabilize and Pitch Stabilize

When a motion sensor is interfaced to the SIM, the data can be stabilised for the roll and pitch motion of the vessel. With the advanced roll stabilisation, in the Sonic 2020, there is no need to stop recording or go off line to change between roll stabilised and non-stabilised mode, nor is there a need to go into the data collection software and identify the data as roll stabilised. The R2Sonic roll stabilisation has been developed based on recommended methods from various data collection software companies.

Roll stabilisation only works within the 130° maximum sector, any swath rotation or large sector size (opening angle) that attempts to go beyond the 130° limit will cause the system to stop roll stabilisation.

Pitch Stabilize is available in the Sonic 2020 (and Sonic 2026). Enabling Pitch Stabilize will steer the transmit pulse in such a way as to counteract the pitching of the vessel. This feature is can be enabled at any time, but it is intended for deeper water survey applications. The operating frequency determines the range within which pitch stabilisation will be able to work.

The maximum steering angles for the 2020/2026, with pitch stabilization enabled, is given by the following equation:

$$\text{maxsteer} = (10 \text{ degrees}) * 400000 / \text{frequency in Hertz}$$

At 400kHz, the system can compensate for ± 10° of pitch. At 200kHz, it can compensate for ± 20° of pitch. At 700kHz, this will decrease to about ± 5.7° of pitch.

As stated in the SIM interfacing, it is recommended that the motion data be at the highest update rate possible.

Sonic 2024	Sonar 1	Sonar 2
Frequency (kHz)	200	400
Ping Rate Limit (Hz)	<input checked="" type="checkbox"/> 2	
Sector Coverage (Deg)	124	120
Sector Rotate (Deg)	0	0
Min Range Gate (m)	0	0
Bottom Sampling	Equiangle quad	
Mission Mode	Down, Bathy Normal	
Roll Stabilize	<input checked="" type="checkbox"/>	
Pitch Stabilize	<input type="checkbox"/>	
Dual Head Mode	Single head	
TruePix Enable	<input checked="" type="checkbox"/>	<input type="checkbox"/>
Snippets Enable	<input checked="" type="checkbox"/>	<input type="checkbox"/>
Water Column Enable	<input checked="" type="checkbox"/>	<input type="checkbox"/>
Intensity Enable	<input checked="" type="checkbox"/>	<input type="checkbox"/>

Figure 49: Roll and Pitch Stabilize

5.6.13 Dual Head Mode (Also see [APPENDIX VII](#).)

The selections are: Single Head, Simultaneous Ping or Alternating Ping. When the dual head mode is selected, a second wedge display will be available in Sonic Control 2000.

The sonar heads have to have exactly the same firmware installed. Use the Status display to verify that both heads have the same firmware; if not, update the oldest firmware sonar head to match the most current firmware sonar head.

Sonic 2024	Sonar 1	Sonar 2
Frequency (kHz)	400	400
Ping Rate Limit (Hz)	<input checked="" type="checkbox"/> 2	
Sector Coverage (Deg)	124	120
Sector Rotate (Deg)	0	0
Min Range Gate (m)	0	0
Bottom Sampling	Equiangle quad	
Mission Mode	Down, Bathy Normal	
Roll Stabilize	<input checked="" type="checkbox"/>	
Pitch Stabilize	<input type="checkbox"/>	
Dual Head Mode	Single head	
TruePix Enable	Single head	
Snippets Enable	Simultaneous ping	
Water Column Enable	<input checked="" type="checkbox"/>	<input type="checkbox"/>
Intensity Enable	<input checked="" type="checkbox"/>	<input type="checkbox"/>

Figure 50: Dual Head Mode

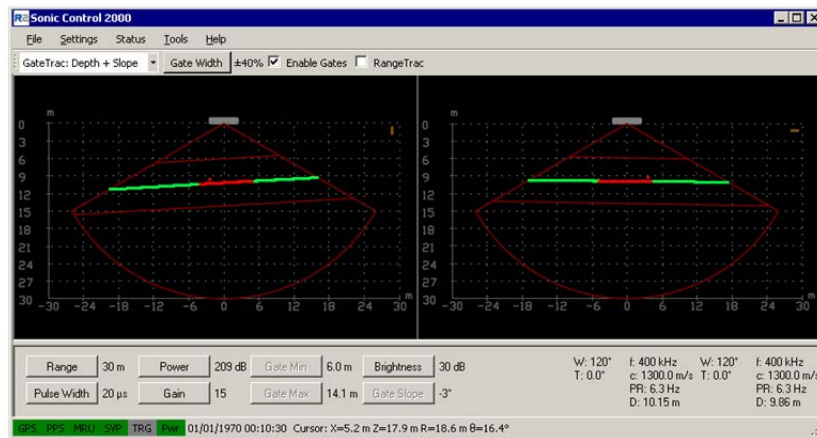

Figure 51: Dual Head Mode active

In dual head mode, certain controls: Range, Power, Pulse Length, and Gain set both sonar heads.

NB. For a dual head system, the Discover function will only list the systems. Discover does not auto-fill the serial numbers for a dual head system. Correct serial numbers must be entered by hand for both systems.

5.6.13.1 Dual Head default settings

To make it easier to set up the system for dual head operation, there is a specific settings file that can be loaded that will set all of the defaults for a dual head configuration. Under the File menu selection, select Load Settings.

Version	3.3	Rev	r000
Date	13-04-2017		

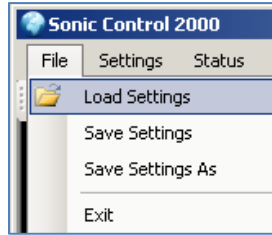

Figure 52: Load Settings menu selection

The available settings files will be shown. There are three Factory Default initialisation files; one for single head and two for dual head: dual head – dual SIM or dual head – single SIM.

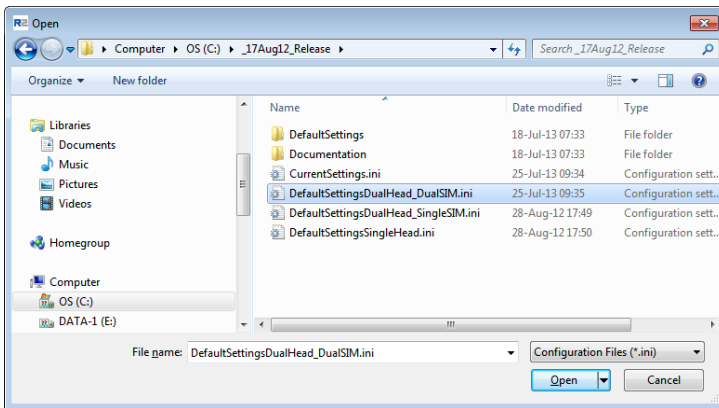
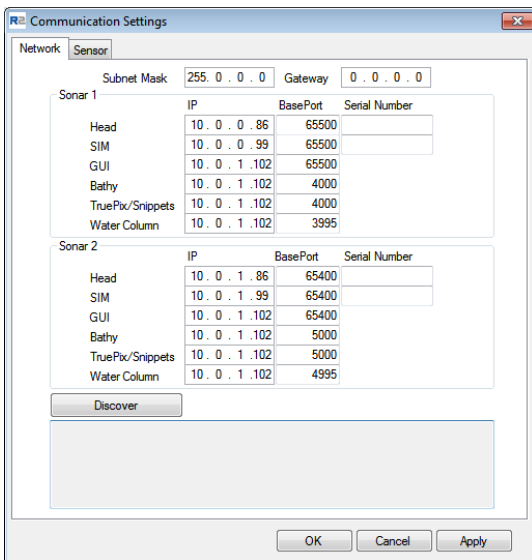

Figure 53: Loading an .ini file

When the file is loaded, Sonic Control will be configured for dual head mode, this includes the default network settings. If using only one SIM, the second SIM IP and BasePort must be set to zero.



Sonar 2	IP	BasePort	Serial Number
Head	10.0.1.86	65400	
SIM	0.0.0.0	0	
GUI	10.0.1.102	65400	
Bathy	10.0.1.102	5000	
TruePix/Snippets	10.0.1.102	5000	
Water Column	10.0.1.102	5000	

When only one SIM is used for a dual head system, the Sonar 2 SIM IP and BasePort need to be set to 0. The Serial Number must be left blank. This is the DefaultSettingsDualHead_SingleSIM.ini

Figure 54: Default dual head Network settings

Version	3.3	Rev	r000
Date	13-04-2017		

5.6.14 TruePix™, Snippets, Water Column, Intensity Enable

If the options TruePix™, Snippets or Water Column are installed (Help | Options, those features can be turned on and off by ticking the box next to appropriate option enable. Intensity Enable will output the bottom detection intensity value in the bathymetry packet; this is a standard feature.

5.6.14.1 TruePix™ Explained

TruePix™ is a new backscatter imagery process developed by R2Sonic to combine the advantages of the traditional side scan record and Snippets, while eliminating their respective disadvantages.

Side scan records are:

- Formed independently from Bottom detection
- Compact
- Inclusive of water column data in the Nadir region
- Suitable for pairing of highlights and targets

Snippets records:

- Suppress reverberation
- Report angle of centre of snippets record for better colocation of backscatter and bathymetry

TruePix™ possesses all of the above advantages and more.

The TruePix™ operation processes all beams into a single continuous times series record for both the port and starboard regions. This continuous record contains intensity and angle values for every point in the record (approximately 10,000). The range corresponds to the sample number times the sample interval, (which is 1/sample rate) like a regular side scan; along with the angular information, the point's elevation and distance from nadir can be calculated.

On the Imagery tab, the user can select to store the Magnitude or the Magnitude + Angle data. The Magnitude + Angle data option will provide the geolocated information; storing Magnitude data provides only imagery.

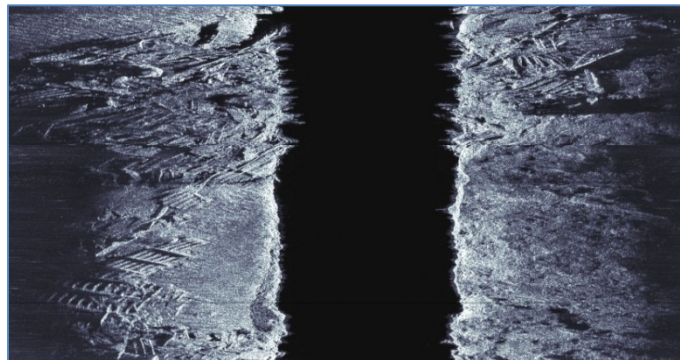

Figure 55: TruePix™ image of wreck debris and sea grass

Version	3.3	Rev	r000
Date	13-04-2017		

5.6.15 Water Column Data Collection

Water column data takes a considerable amount of the uplink bandwidth. The network interface card (NIC) settings are very important to allow the computer to work with water column data collection. There are also Registry settings that can be adjusted; please contact r2support@r2sonic.com for details on changing registry settings.

The NIC has to be Gigabit. It is very important to increase the Receive Buffer size, for the NIC, so that the NIC can handle the flow of the data. Increase the value to the highest number possible. Depending on the NIC, there is more than one way to access the Receive Buffer setting on the Advanced Tab, under Configure.

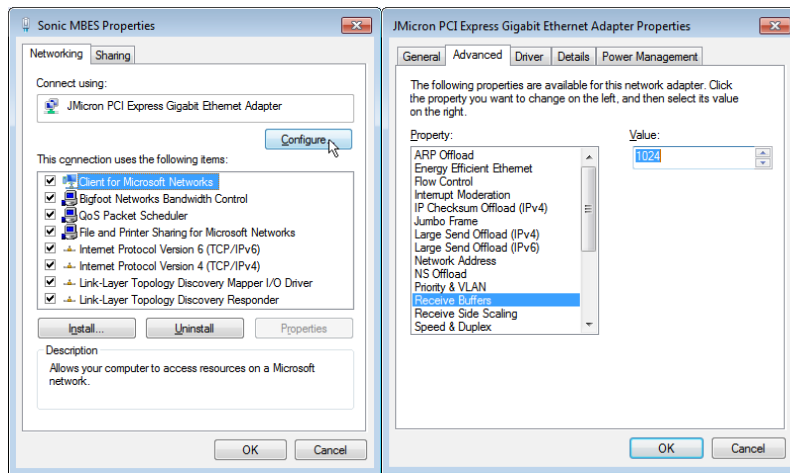

Figure 56: Network Card Properties

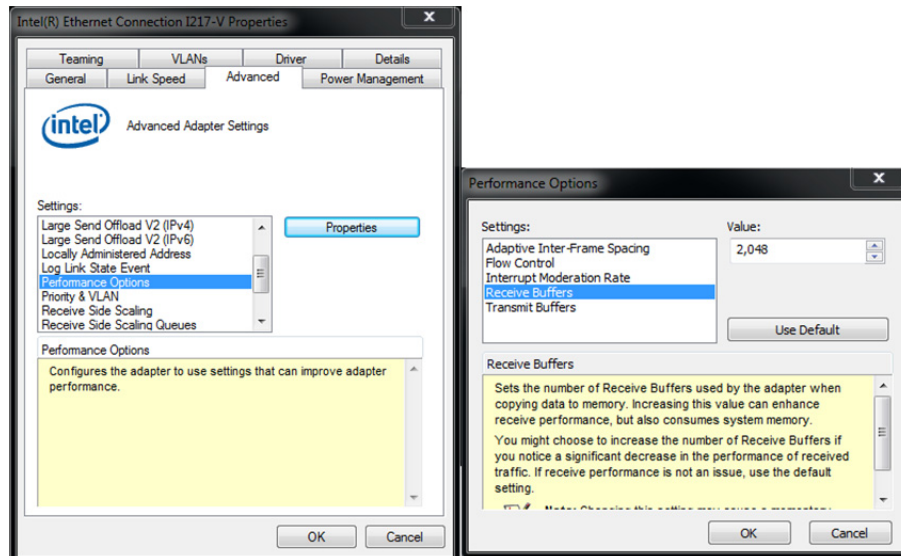

Figure 57: Intel NIC Properties

Version	3.3	Rev	r000
Date	13-04-2017		

5.7 MultiMode

First introduced in 2016, the MultiSpectral mode provides a means to ping at different frequencies with each subsequent ping.

R2Sonic has greatly enhanced the ability to tune the sonar on a ping to ping basis beyond just the frequency. The MultiSpectral mode is now a selection in a more enhanced MultiMode function.

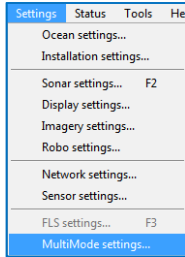

Figure 59: Settings | MultiMode

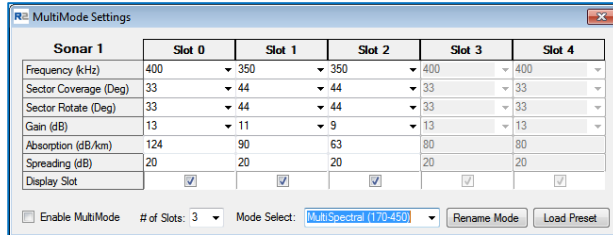

Figure 58: MultiMode Window

Where the MultiSpectral mode allowed the user to select a Frequency, Gain, Absorption and Spreading loss, MultiMode allows for also setting Sector Coverage and Sector Rotate.

From Mode Select, the user can select the MultiSpectral mode or a specialised UHR feature: Pipeline Mode.

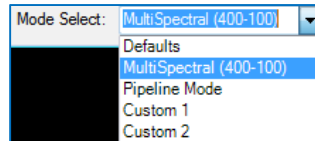

Figure 60: MultiMode Selections

5.7.1 MultiSpectral Mode™

R2Sonic developed the MultiSpectral Mode™ to meet the growing demands of those involved in extending the use and capabilities of multibeam backscatter. To a much lesser extent this mode may provide benefits in some bathymetric surveys.

When enabled, this mode is used to sequentially shift the operating frequency on a ping-to-ping basis. Up to five different frequencies can be set to be shifted between. There are four preset, MultiSpectral modes; three of which are selectable under Presets, but the user can enter any values that they wish

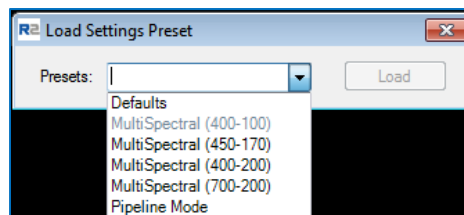

Figure 61: MultiMode Preset Settings

When loading a configuration, from the Presets, the user will be notified that the current settings are about to be overwritten.

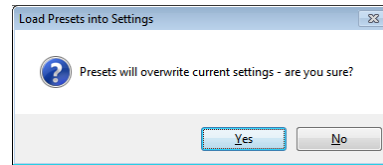

Figure 62: Preset warning

Under 'Mission Mode' there are preset options that can be used as a starting point or two Custom settings, which can be renamed by selecting the 'Rename Mode' option.

The number of frequencies, which are required, can be manually set by the '# (number) of Slots' drop down menu. Each Slot can be set up manually by either entering the desired parameters or using the drop down menu. An alternative is that if Sonic Control is currently using the desired configuration, the user merely clicks on the associated Slot column heading and those settings will be automatically transferred.

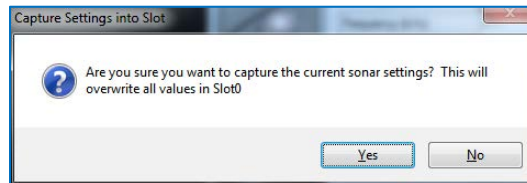

Figure 63: Capture settings prompt

When 'Enable MultiMode' is selected, by clicking on the associated box, the sonar will ping with Slot 0's configuration and, on the next ping, use Slot 1's configuration, then Slot 2's configuration and etc. When the last Slot is used, the sonar starts over at Slot 0's configuration.

When MultiMode is enabled, the sector coverage and sector rotate will no longer be able to be adjusted via the computer mouse; the only way to change the sector coverage and the sector rotate is through the MultiMode settings.

5.7.2 Pipeline Mode

Pipeline mode is designed for UHR capable systems. When enabled, the sonar will switch, ping by ping, between UHR mode and standard mode. This capability means that the pipeline or other linear feature is mapped with UHR and the full resolution of the surrounding natural bottom is mapped at the same time. This is opposed to systems that sacrifice beams to concentrate on a linear feature and sacrifice beams for the surrounding seafloor; pipeline mode provides full resolution of the feature as well as the seafloor on either side. Both the pipeline and the corridor receive full resolution coverage.

When enabled, the sonar will ping at 700kHz and then 400kHz (or other selectable frequency). The default sector size for UHR is 70°; default for 400kHz is 125°. Pipeline mode can also benefit from using UHD bottom sampling. It is recommended that prior to entering pipeline mode, the sonar be

Version	3.3	Rev	r000
Date	13-04-2017		

put to 700kHz and the power adjusted for that frequency. If this is not done, it could be the Power setting may be too low for 700kHz and the result will be noise instead of a good bottom return.

For a dual head installation, MultiMode will automatically go to a dual head configurable condition.

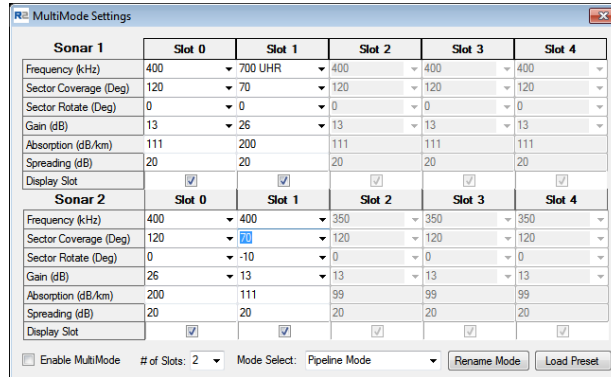

Figure 64: Dual Head Multimode

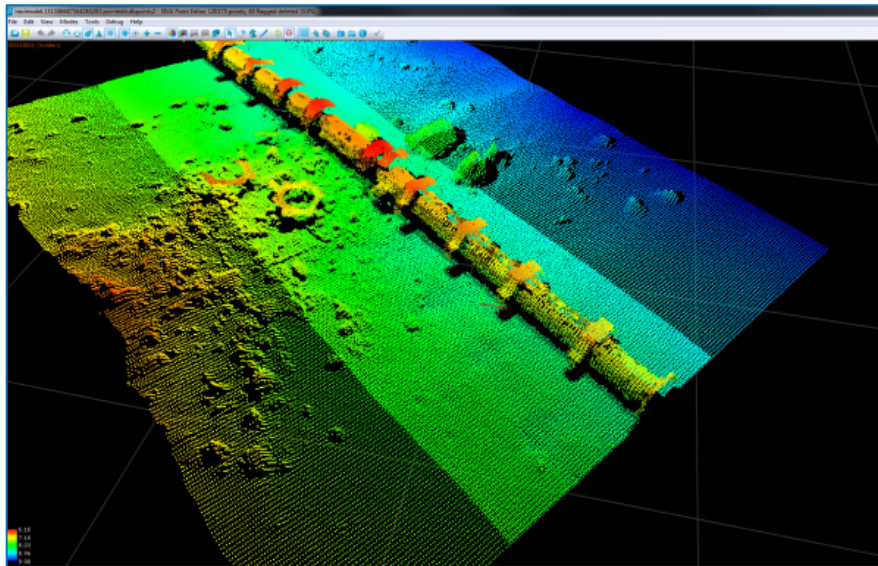

Figure 65: Pipeline Mode (image courtesy of DOF Subsea)

5.8 Ocean Setting

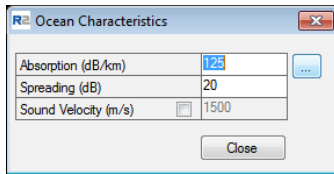

Figure 66: Ocean Characteristics

Ocean Characteristics include Absorption and Spreading loss, which are the main components of the Time Variable Gain (TVG) computation, and manual Sound Velocity (for receive beam steering).

5.8.1 Absorption: 0 – 200 dB/km

Absorption is influenced primarily by frequency and the chemical compounds of boric acid $B(OH)_3$ and magnesium sulphate $MgSO_4$.

It is highly recommended that the local absorption value be entered. The button, next the absorption input will call up a calculator that will allow setting the correct parameters to derive the proper value to be entered.

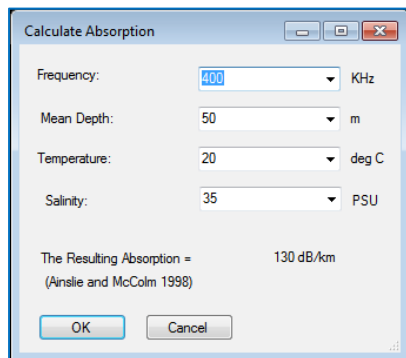

Either manually enter the values for each variable or use the dropdown selection to choose a value.

Enter the resultant value into Absorption; it is not automatically updated from the calculator.

Figure 67: Absorption Calculator

[Appendix VI](#) provides a table of absorption values based on operating frequency.

5.8.2 Spreading Loss: 0 – 60 dB

Spreading loss is the loss of intensity of a sound wave, due to dispersion of the wave front. It is a geometrical phenomenon and is independent of frequency. The sound wave propagates in a spherical manner, the area of the wave front increases as the square of the distance from the source. Therefore, the sound intensity decreases with the square of the distance from the projector. Spreading loss is not dependent on frequency.

Spreading loss is not a setting that normally needs to be changed except when surveying in deeper depths. As spreading loss is not dependent on frequency, the setting is unaffected by a change in operating frequency. A general default value of 20 – 30 is normally sufficient for most survey

Version	3.3	Rev	r000
Date	13-04-2017		

conditions. The standard default is 20dB. The value should be increased when surveying into deeper depths (>100 metres).

NB. In very shallow water (2m or less) it may be more advantageous to use Fixed Gain. To put the system into Fixed Gain enter zero (0) for both Spreading Loss and Absorption.

For more detailed information on absorption and spreading loss, please refer to Appendix V Basic Acoustic Theory.

5.8.3 Time Variable Gain

Absorption and spreading loss are the main components of the Time Variable Gain (TVG) computation.

TVG Equation

$$TVG = 2 * R * \alpha / 1000 + Sp * \log(R) + G$$

- α** = Absorption Loss db/km
- R** = Range in metres
- Sp** = Spreading loss coefficient
- G** = Gain from Sonar Control setting

TVG is employed in underwater acoustics to compensate for the nature of the reflected acoustic energy. When an acoustic pulse is transmitted in a wide pattern, the first returns will generally be from the nadir region and very strong. As the receive window time lengthens, the weaker returns are received. Using a fixed gain would apply either too much gain for the early returns or insufficient gain for the later returns. The solution is to use TVG. The function of TVG is to increase gain continuously throughout the receive cycle. Therefore, smaller gain corresponds with the first returns (normally the strongest) and higher gain corresponds to the later returns (normally the weakest). This function is represented in, what is called, the TVG curve.

5.8.3.1 TVG Curve

The TVG curve can be either shallow or steep depending mostly on the Absorption value to define the shape of the curve. The Spreading Loss will determine the amplitude of the gain.

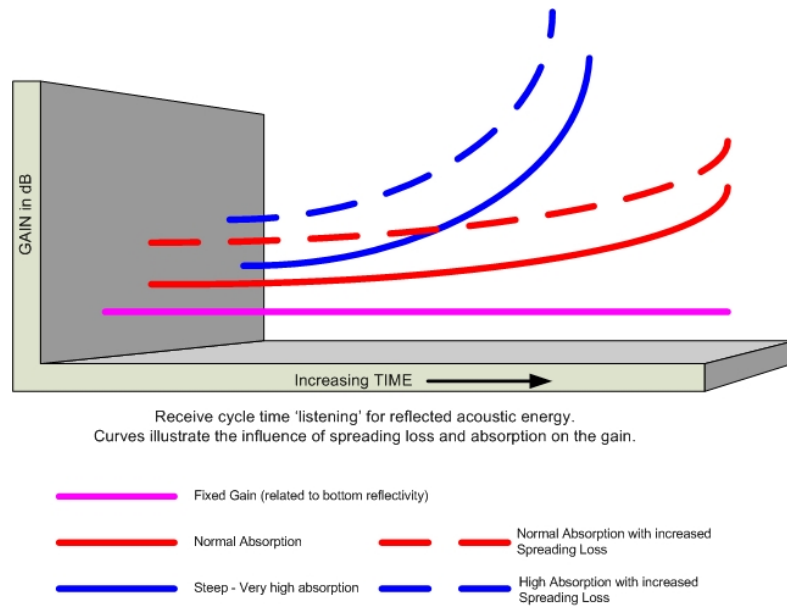

Figure 68: TVG Curve Concept

5.8.3.2 Sound Velocity

The speed of sound, at the receiver's face, is required to do the receive beam steering, which is required for all flat array sonars. The angular acoustic wave front strikes each receive element, but at a different time and phase depending on the angle of the return. By introducing a variable delay to each receive element's information, the phases can be aligned and the beam can be 'steered' in the direction of the return. In order to accurately apply the correct delay, three factors have to be known or measured: The physical distance between each receive element is known, the time of reception at each receive element is measured, the speed of sound at the receiver face must be known or measured (for this reason there is a sound velocity probe attached to the mounting frame).

The beam steering can be accomplished, without a sound velocity probe, by entering in the correct sound velocity for the area around the sonar head. To manually enter a sound velocity, check the box for 'Use Custom velocity' and enter a velocity. The SVP indicator, in the GUI, will change from Green to Yellow. SVP TRG Pwr

Version	3.3	Rev	r000
Date	13-04-2017		

WARNING

The wrong sound velocity, at the sonar head, will cause erroneous data. There are currently no known post processing tools to correct for this.

If the sound velocity is wrong, the beam steering will be in error. If the sound velocity is greater than what it really is at the face of the receiver, the ranges will be shorter and thus the bottom will curve up or ‘smile’. If the sound velocity is less than what it really is at the face of the receiver, the ranges will be longer and the bottom will curve down or ‘frown’. This error can be confused with a refraction error caused by the wrong water column sound velocity profile. The refraction error can be corrected by entering the correct water column sound velocity profile, however; erroneous beam steering cannot be corrected as it is part of the beam data.

Therefore, for accurate beam steering to take place, an accurate sound velocity must be provided to the Sonic 2020.

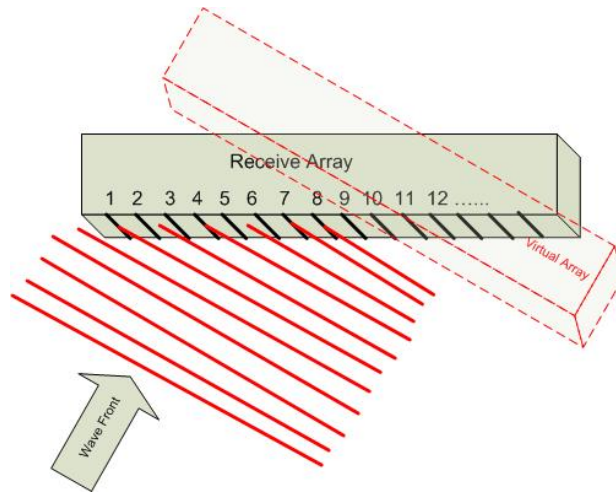

Figure 69: The angular acoustic wave front will strike each receive element at a different time

As the wave progresses across the face, each receive element will see the wave at a slightly different time and thus a slightly different phase. The formed beam is steered in the direction of the acoustic wave by selectively adding delay to each receive element’s data until the data is coherent and in phase. In the above figure, receive element 1 would have the most delay applied, whereas receive element 8 would have no delay; thus a ‘virtual array’ will be formed.

Version	3.3	Rev	r000
Date	13-04-2017		

5.9 Installation Settings

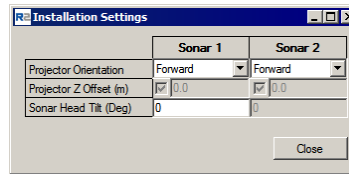

Figure 70: Installation Settings

5.9.1 Projector Orientation

With the Sonic 2020, the projector is to the side of the sonar head and not a separate part of the sonar head. For the Sonic 2020, Projector Forward is the orientation when the Sonic 2020 is installed, as preferred, with the deck lead connector and SV probe facing aft and the receiver forward. In the case of the Sonic 2020, it is Receiver Forward or Receiver Aft.

5.9.2 Projector Z Offset (m)

Sonic Control automatically senses which sonar is attached and will set the correct Projector Z offset. There is no projector Z offset for the 2020, the Projector Z Offset is 0.000

5.9.3 Head Tilt

If the sonar head is physically tilted to port or starboard, the tilt angle is entered here to rotate the wedge and depth gates. The head tilt limits are $\pm 45^\circ$.

5.10 Status

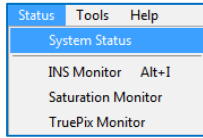
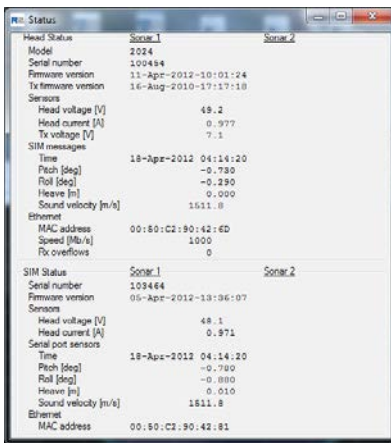

Figure 71: Status Options

The INS Monitor is covered in [Appendix I](#).

5.10.1 System Status

The Status report provides a detailed list of the current system parameters in both the sonar head and the SIM, including current version of installed firmware and serial input messages.



It is quite normal that the SIM messages, in the Head Status, differ from the Serial port sensor data (in the SIM Status). The Head Status reflects what is received at the head, from the SIM.

Figure 72: Status Message

The upper area reflects the sonar head status; the lower area reflects the SIM status. In the SIM Status area, the real-time serial input data is shown. In the Head Status area, the received SIM message, which contains the serial received serial data, is shown. The Head Status Response time (μ s) reflects the time required for a message (such as a time request) to go from the head to the SIM and return. The Response time can be very useful in ROV installations to determine any latency issues with the communication between the ROV and the SIM.

Version	3.3	Rev	r000
Date	13-04-2017		

5.10.2 Saturation Monitor

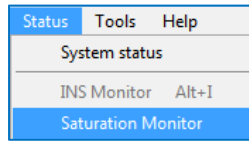

Figure 73: Status | Saturation Monitor

The Saturation Monitor provides the user with the means of monitoring the sonar’s receiver signal level. The Saturation Monitor is a new development by R2Sonic based on the work and input of Dr Jonathan Beaudoin (Center for Coastal Mapping, University of New Hampshire).

The Saturation Monitor enables the user to set sonar parameters to collect meaningful backscatter; maintaining signal levels that keep the receivers within their linear region of response. The Saturation Monitor allows the user to maintain consistent intensity levels. When the Saturation Monitor is enabled, the Intensity Enable (Sonar Settings) will be automatically enabled.

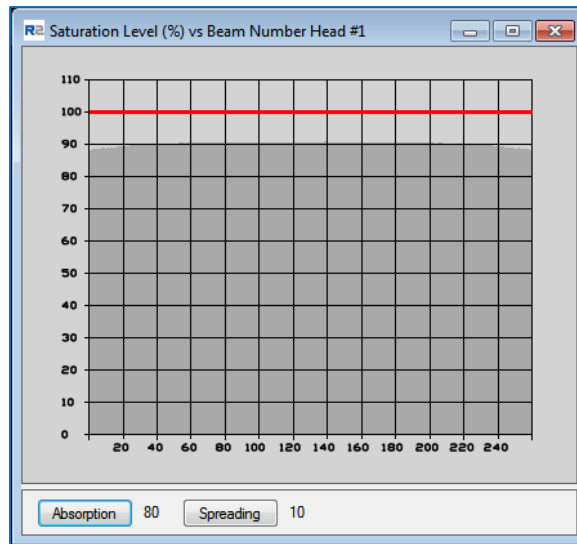

Figure 74: Saturation Monitor

The factors that control intensity are:

1. Power
2. Pulse Width
3. Gain
4. TVG Parameters
 - a. Spreading Loss
 - b. Absorption

Version	3.3	Rev	r000
Date	13-04-2017		

When the Saturation Monitor is opened, the user can adjust the above parameters to maintain signal levels below the red 100% saturation line. The TVG parameters can be changed, directly in the monitor window, without having to go to the Settings | Ocean menu.

5.10.3 TruePix Monitor

The TruePix monitor has been added to Sonic Control to provide users with a means to visualise the real time imagery. It is important to note that with the addition of the TruePix monitor the manner in which TruePix are transmitted, from the head, has changed. TruePix data will only flow to the data collection software when Sonic Control is open. If Sonic Control is closed, the bathymetry (as well as Snippet and water column) data will still flow to the data collection software, but the TruePix data will not.

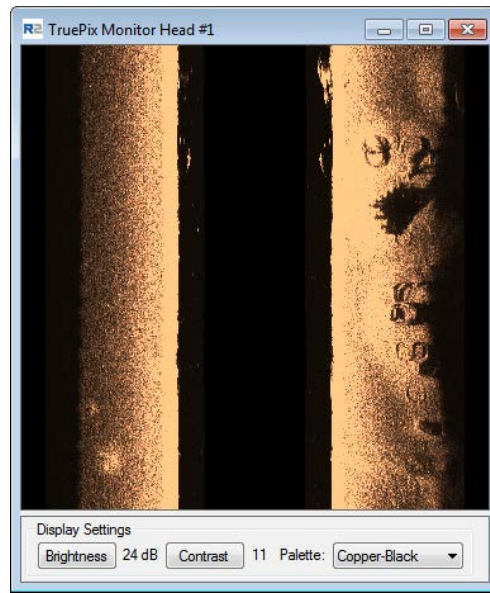
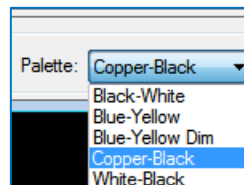

Figure 75: TruePix Monitor

There are multiple palettes available and can be change and, when change, will take immediate effect on the displayed data. The Brightness and Contrast can be toggle up and down using the mouse buttons after first clicking on either Brightness or Contrast.

Figure 76: TruePix monitor palette



5.11 Tools

5.11.1 Engineering

This area is for engineering commands to be sent to either the head or SIM for either trouble shooting or system analysis. This area should not be used except by the direction of R2Sonic engineers.

5.11.2 Firmware Update



When R2Sonic issues a firmware update, it will be made available to the customer, allowing the customer to update their system by themselves. There are two firmware updates possible: SIM update and/or sonar head update. The update file will be designated either Simb\$ (SIM) or Head\$ (sonar head); the extension will be '*.bin'. There is also an option to update the transmitter firmware; this is not the same as the sonar head firmware

Prior to updating firmware, make sure that none of the computer's other Ethernet ports are in use; it may be necessary to shut down other sensors that use the Ethernet for data transfer. Connect the SIM directly to the computer's network interface card.

Place the update file in the Sonic Control directory on the computer hard drive. Go to Tools | Firmware Update; the files will be shown, if not use the browse button to search for the correct upgrade file to download to either the SIM or the sonar head. If there is an upgrade for both the sonar head and the SIM, it is recommended to upgrade the SIM first. Updates are not fully installed until the system has been power cycled

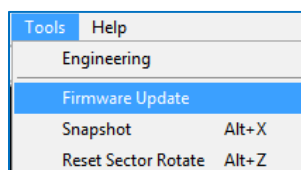

Figure 77: Select Tools; Firmware Update

Version	3.3	Rev	r000
Date	13-04-2017		

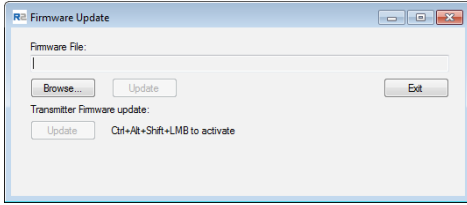

Figure 78: The Browse button will open the current GUI's directory

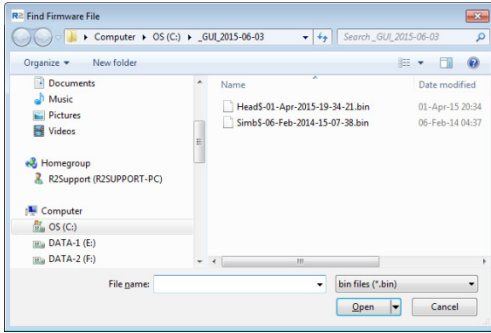

Figure 79: Select correct update .bin file

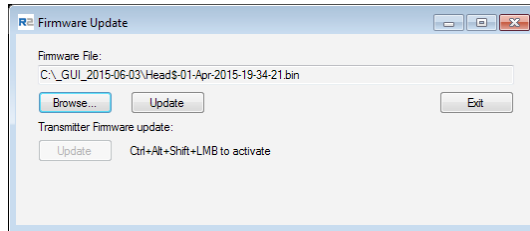

Figure 80: A batch file will automatically load the upgrade file

Once the Update button is clicked on, a batch file will automatically run and download the .bin to the appropriate location.

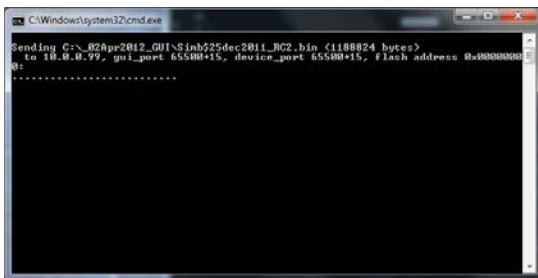

Figure 81: The start of a firmware update. A series of dots represents the update progress.

Version	3.3	Rev	r000
Date	13-04-2017		

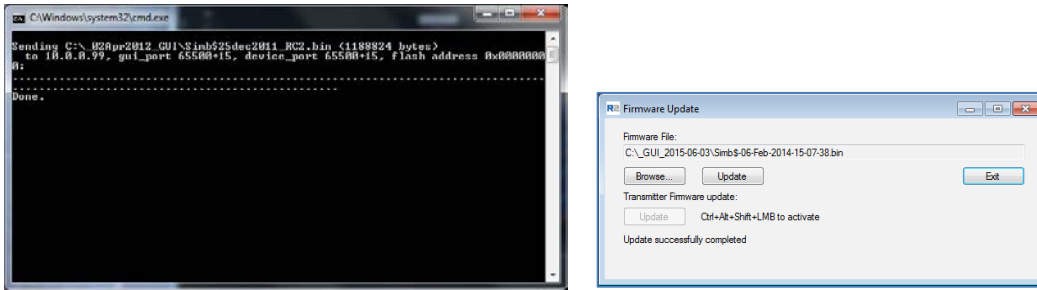

Figure 82: Firmware update completed, the window will close automatically and the Update window will show successful completion

5.11.2.1 Firewall and Virus Checker Issues

A major problem can arise from having a firewall turned on (either Windows or third party) and virus checkers. Having a firewall on will cause a window to pop up, from the firewall, during the upgrade procedure requesting permission to run the upgrade; selecting yes (to allow) it proceeds. In the CMD window a series of 'r' will appear to show the update procedure is trying to perform the update, but is being prevented from doing so. Once the firewall has been turned off, or trained, the 'r' will change to the normal update dots.

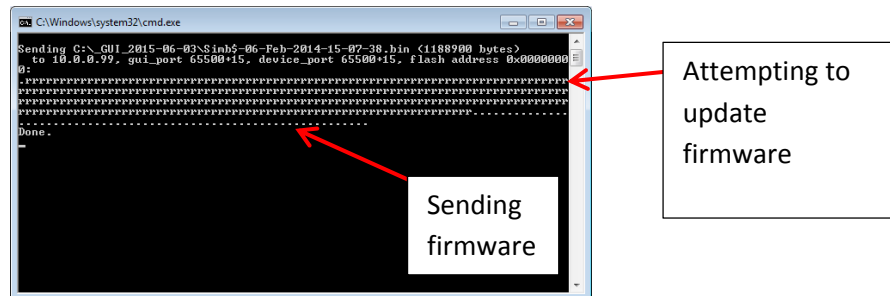
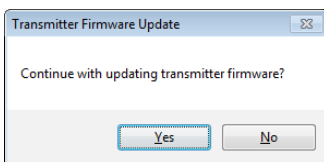

Figure 83: Indication of attempts to update firmware

5.11.2.2 Transmitter Firmware Update

When the transmitter firmware is to be updated, it is a special update. Being a special update, more steps have to be taken, which is why a series of keys and mouse clicks have to be used to activate the update. The transmitter firmware is embedded with the normal sonar head firmware. If the transmitter firmware is to be updated, click the transmitter firmware update button (with associated key strokes and LMB). The head will stop uplinking data (spinner stops) while the transmit firmware is being loaded. When the firmware is updated, the sonar will start pinging normally.



Version	3.3	Rev	r000
Date	13-04-2017		

5.11.3 Snapshot and Reset Sector Rotate

Both of these features can be activated using hot keys. Snapshot will capture a single image of the GUI. Unless a folder is selected, on the Imagery Tab, the captured image will be stored within the GUI files. A snapshot can be taken by using Alt X.

With the ability to orientate the swath to port or starboard, an easy way to return the swath to zero rotation, is by using Alt Z

5.12 Help

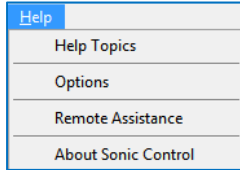

Figure 84: Help Menu

5.12.1 Help Topics

Selecting Help Topics will bring up an electronic copy of the Operation Manual; this is the same as the paper version of the Operation Manual.

5.12.2 Options

The Options display shows the upgrades that have been installed in the system. The installed options are enabled or disabled, as required, in the Sonar Settings (except for the 3000m depth rating upgrade); this display merely shows what is available for the system. . Enabling an installed option's output is done in Sonar Settings.

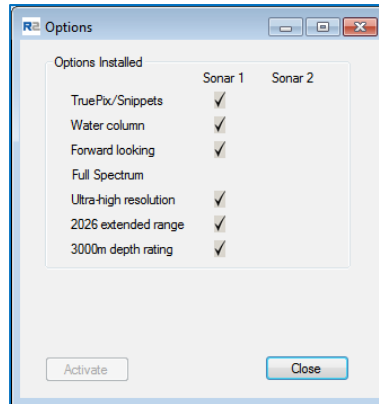

Figure 85: Installed Options

5.12.3 Remote Assistance

R2Sonic support can assist in setting up the system or trouble shooting the system, remotely, by taking control of the customer's computer. An internet connection is required.

Version	3.3	Rev	r000
Date	13-04-2017		

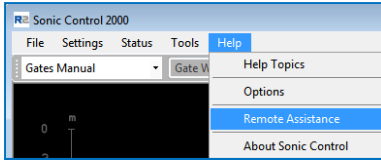
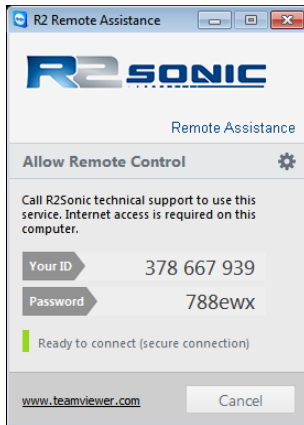

Figure 86: Remote Assistance

When Remote Assistance is selected, a separate program will be launched that will allow R2Sonic Support to remotely control the computer on which Sonic Control is installed. The Remote Assistance window will contain an ID and Password. Contact R2 Support (+1.805.259.8142) and provide the ID number and Password, this will allow support to connect to the computer and take control of it to assist in setup up or trouble shooting. It is preferred that prior to starting the Remote Assistance program that R2Sonic Support be notified via email: R2Support@r2sonic.com or called (SMS is fine), at the above number, to alert them that a Remote Assistance session is requested. Please use UTC or GMT time.



Remote Assistance uses TeamViewer™ software licensed to R2Sonic. When contacting R2Sonic, requesting Remote Assistance, a mutually agreed upon time will be established for the session. When it is time for the session, run Remote Assistance. In the Remote Assistance window, there will be the unique ID, which identifies the computer and the password, which allows R2Sonic Support to take remote control of the computer. This information has to be sent to the R2Sonic personnel that will be assisting

Figure 87: Remote Assistance Window

5.12.4 About Sonic Control

The About Sonic Control shows the version of Sonic Control that is being used. This can be of importance if a GUI is used that does not match the features of the sonar firmware or the sonar firmware does not match the features of the GUI.

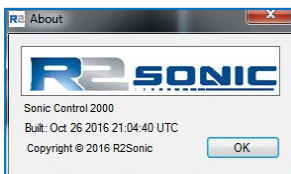

Figure 88: About, provides the GUI version

Version	3.3	Rev	r000
Date	13-04-2017		

5.13 Display settings

The user can customise the colour scheme of Sonic Control's main window.

Dot Colors provides a means to view instantaneous information by colouring the bottom detections dots for the detection algorithm being employed when Magnitude is selected.

Selecting Intensity provides a grey scale representation of the return data's acoustic strength. This Dot Color mode can be very helpful in balancing the power, gain and pulse length for optimal operation of the system. The Brightness (dB) sets a base reference for the depiction of the acoustic return strength.

Bathy-dot Size selection is either normal (1-pixel) or large (3-pixel); default is large. Using the 1-pixel size is recommended when viewing the Acoustic Imagery, in the wedge display.

Under Draggable Sector Outline, the user can enable or disable the feature to use the mouse cursor to change opening angle and swath rotation.

Acoustic Image the Image Enable box turns the wedge's acoustic imagery on and off. The drop down, under Image Enable, allows the user to select the colour palette for wedge's acoustic imagery.

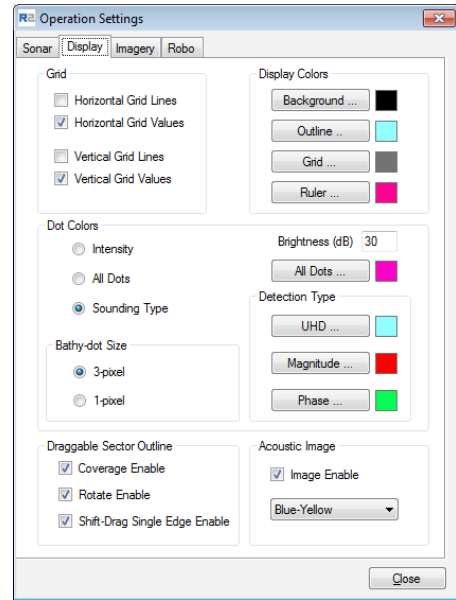

Figure 89: Display Settings

5.14 Imagery

On the Imagery Tab, the user can select the imagery data (TruePix™ and Water Column) formats for logging. The maximum data size is shown to provide the user with an idea of what to expect when storing imagery data.

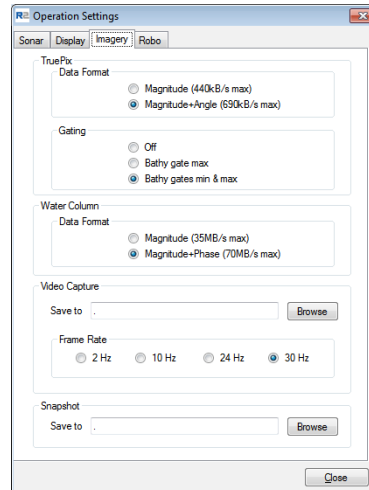

Figure 90: Imagery Settings

5.14.1 TruePix™ and Water Column

The size of the TruePix™ and Water Column formats are given; the user can select either of the formats (this would depend on the users' end product). For TruePix™, if geolocated data is required, the Magnitude+Angle format must be used.

Data rates for Water Column and TruePix are also affected by pulse width. Longer pulse widths will reduce data rate approximately:

- 15-30us: 1/1 data rate
- 35-65us: 1/2 data rate
- 70-135us: 1/4 data rate
- >= 140us: 1/8 data rate

5.14.2 Video Capture

The GUI Record button, in the main window, will capture the entire GUI image in a video file. The format is *.mkv; further details are in [Section 5.16](#). Select a folder location to store videos, if no folder is selected, the video file will be stored within the GUI files.

To maintain a useable video file size, select the appropriate frame rate for the video.

Version	3.3	Rev	r000
Date	13-04-2017		

5.15 ROBO Automatic Sonar Operation

The sonar can be setup to automatically change Power, Pulse Width and Gain based on the Range setting and the percentage of receiver saturation. This feature is designed for ease of use, but the user must be aware that environmental factors play a very large part as to how successful the Robo settings control the sonar. Robo operation does not negate the need for a user to pay attention to the sonar. As with all automatic features, Robo operation is designed for a non-challenging environment.

Robo operation, Range Trac and Gate Trac can be used together for an almost hands free operation of the sonar (within environmental limits).

Robo operation relies on a look up table, which can be easily modified by the user. Enabling Robo operation is initiated by selecting Robo in the control line.

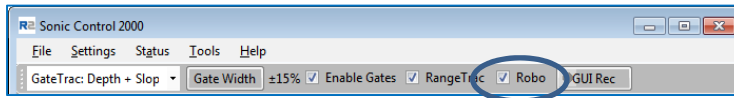

Figure 91: Enabling ROBO Operation

When Robo mode is enabled, Power, Pulse Width and Gain will be greyed out. The Saturation value will be added, on the left side, to show the value being used for the automatic change of gain.

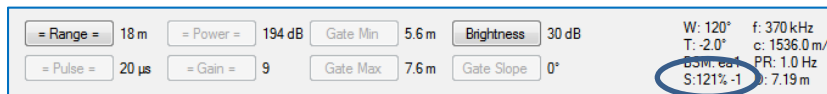

Figure 92: Operational settings with ROBO active

5.15.1 ROBO Settings

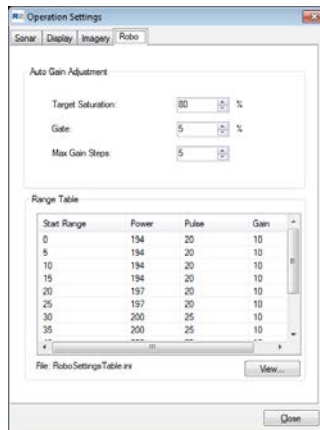
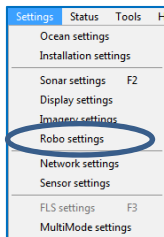

Figure 93: ROBO Settings

5.15.1.1 Auto Gain Adjustment

The Robo feature uses the Range setting and the percentage of receiver saturation to determine when to change the Power, Pulse Width and Gain.

The Range setting will determine the Power and Pulse Width. Receiver saturation percentage will set the Gain. The Saturation Monitor is covered in [Section 5.10.4](#)

The Target Saturation is the level of receiver saturation to be maintained. The Gate is the limit, about the Target Saturation, before a change is made. Max Gain Steps determines how the gain should increase or decrease.

5.15.1.2 Range Table

The current settings are shown in the Range Table; the values cannot be edited within this window. Selecting View will link directly to the RoboSettingsTable.ini file location. The ini file can be opened in Notepad or any text editor and modified to suit local survey conditions.

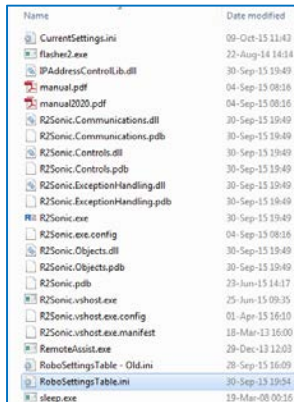

Figure 95: In ROBO Settings, View Link to the ini file

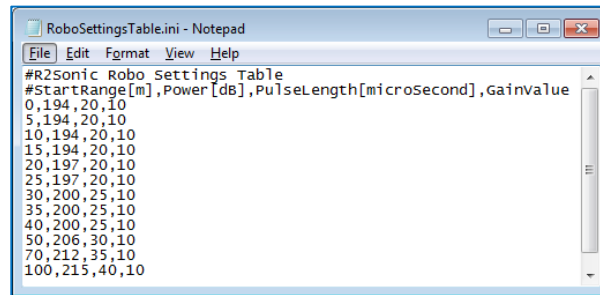

Figure 94: ROBO Settings Table

Version	3.3	Rev	r000
Date	13-04-2017		

5.16 Main Operation Parameters

The main operating parameters of the Sonic 2020 are controlled by the buttons in the lower portion of the window.

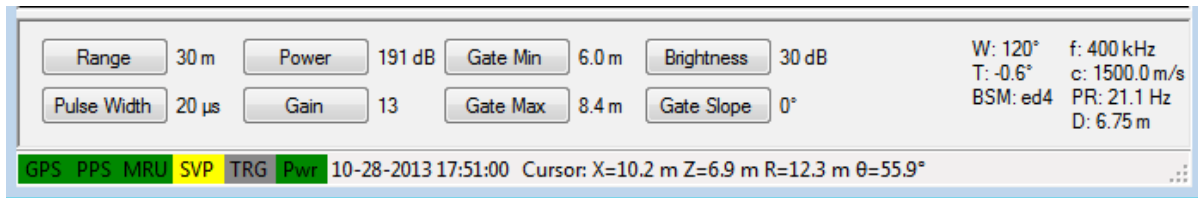

Figure 96: Operating parameter buttons

To change a value, position the mouse cursor on the button then use the left mouse button to decrease the value and the right mouse button to increase the value.

The right hand side of the panel provides system information:

- W: Wedge sector (opening angle)
- T: Sector Tilt angle
- BSM: Bottom Sampling Mode
- f: Operating frequency
- c: Sound velocity at the sonar head
- PR: Ping rate
- D: Nadir depth

The lower left area displays the colour of the SIM communications LEDs, time, which is decoded from the bathymetry packet and the current cursor position, relative to the sonar head. The angular information is represented by theta θ .

5.16.1 Range: 0 – 1200 metres

The Range setting sets the maximum *slant range* of the Sonic 2020. The maximum slant range determines how fast the Sonic 2020 can transmit; this is the Ping Rate. What the range setting is doing is telling the Sonic 2020 the length of time that the receivers should be ‘listening’ for the reflected acoustic energy. If the Range setting is too short, some of the returning energy will be received during the subsequent receive period, i.e. out of synch, and will be seen as noise.

It is easy for the operator to maintain the correct Range setting by noting the bottom detection dots relationship to the straight legs of the wedge display.

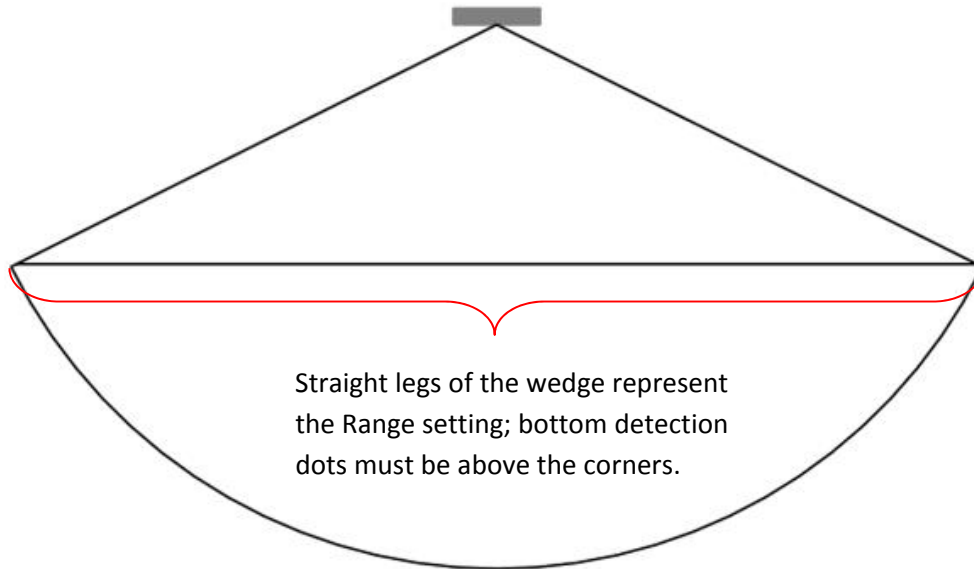

Figure 97: Range setting represented in the wedge display

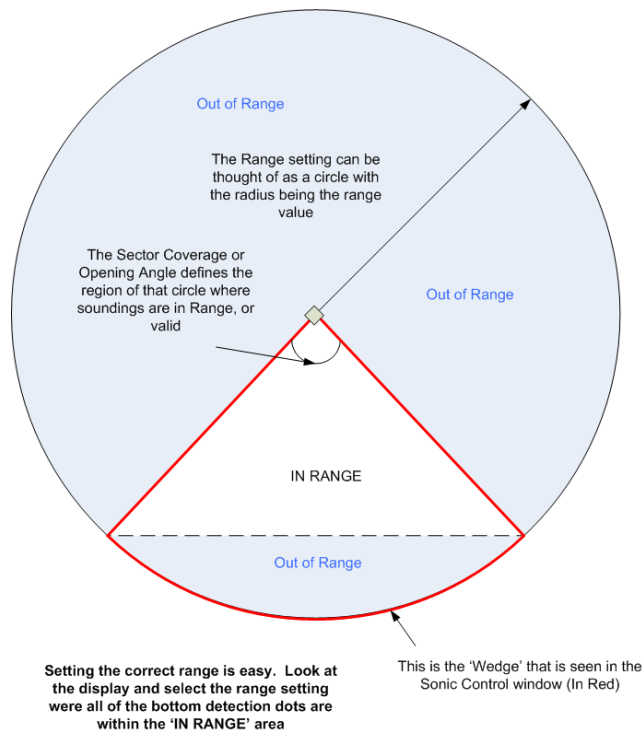

Figure 98: Graphical concept of the Wedge Display

Version	3.3	Rev	r000
Date	13-04-2017		

5.16.2 RangeTrac™ – Sonic Control automatically sets correct range

RangeTrac™ removes the need to manually set the correct range; Sonic Control will determine the correct range and maintain the range setting, no matter how rapidly the depth may change.

RangeTrac is enabled by selecting the box, next to RangeTrac, in Sonic Control.



Figure 99: RangeTrac enabled

The Range button will change to reflect that Sonic Control is operating in RangeTrac mode.

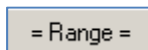

Sonic Control will continue to operate in RangeTrac mode until the user manually changes range or RangeTrac is deselected.

When using RangeTrac, the user manually sets the range first and then turns on RangeTrac; from that point on, there is no need for the user to adjust the Range setting. RangeTrac will automatically set the correct Range for the water depth. RangeTrac will also optimise the ping rate for the determined range.

There are no limits to RangeTrac as far as steepness of slope or amount of variability. RangeTrac can be used simultaneously with GateTrac, in both the Depth and the Depth + Slope modes.

5.16.3 Power: 177 – 207 dB

The Power setting sets the source level of the transmit pulse. The Sonic 2020 should be operated with sufficient power to enable good acoustic returns from the sea floor. The value will change based on water depth, bottom composition, and operating frequency. In general, higher power is better for getting decent bottom returns rather than using receiver gain to obtain the returns. If the Power setting is too low, more receiver gain will need to be used to capture the bottom returns; this can mean more extraneous noise will also be received. The increase in noise will require more processing time; it is better to slightly increase the Power to increase the strength of the bottom returns and, thus, allow for a lower receiver gain setting. If too much power is used, the receivers can be over-driven (saturated); this will result in noisy data and/or erroneous nadir depth readings. A good balance of source level (Power) and receiver gain is the desired end. Shift – left click will turn transmitter power off (Power 0).

5.16.4 Pulse Length: 15µsec – 1115µsec

Pulse length determines the transmit pulse duration time. The Sonic 2020 pulse length range is from 15µsec to 1115µsec. The pulse length does not affect the pulse amplitude, which is determined by the Power setting. The general guide line is to maintain as short a pulse length as possible to optimise the resolution, but not so short as to weaken the transmit pulse. It is suggested

Version	3.3	Rev	r000
Date	13-04-2017		

that 20µsec pulse width be considered the minimum to use. Generally, as the water gets deeper the pulse length will have to be increased to get more ‘total’ power in the water. The default pulse length will depend on the chosen operating frequency.

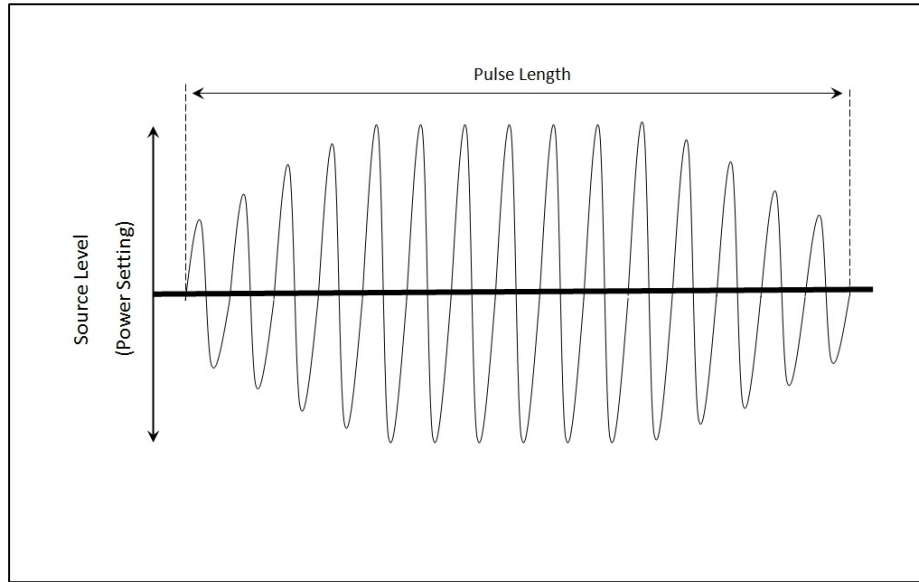

Figure 100: Transmit Pulse

The Pulse Width and sample rate are closely related. In order to reach the maximum pulse with, for a given sample rate, use Shift + mouse click to increase/decrease the pulse width in quarter octave steps. Sample rate change at 35, 70, 140, 280...µsecs.

- Shift+RMB = Increase in quarter octave steps
- Shift+LMB = Decrease in quarter octave steps

5.16.5 Gain: 1 – 45

Receiver gain is in 2 dB steps from 1 to 45. This adjusts the receive gain of the sonar head receivers.

5.16.6 Depth Gates: GateTrac™

The depth gate allows the user to eliminate noise or other acoustic interference by the limits set in the Minimum and Maximum Depth. There are manually selected gates, GateTrac: Depth and GateTrac: Depth + Slope.

Gates are enabled by selecting the check box next to Enable Gates.

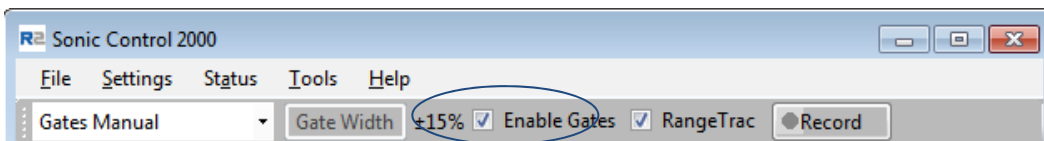

Figure 101: Enable Gates

Version	3.3	Rev	r000
Date	13-04-2017		

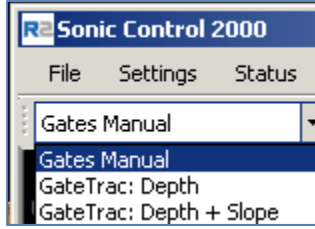

Figure 102: Manual and GateTrac selections

5.16.6.1 Gates Manual

The depth gates can also be changed using the mouse in the wedge display. Click and drag on either depth gate; the cursor will change to a double arrow \updownarrow , drag the gate to the new depth and release the mouse button. The depth gate position is visible in the lower left hand section of the display. When the mouse button is released the gate will be updated in the Operation Parameters area.

To move both gates, simultaneously, use the right mouse button and both gates will move, keeping the same relationship.

In Manual mode, the gate slope can be adjusted by using the Gate Slope button in the Operation area. The gates can be tilted up to $\pm 90^\circ$.

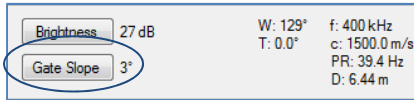

Figure 103: Manually adjust the gate slope

5.16.6.2 GateTrac: Depth

GateTrac: Depth will automatically adjust the gates, for water depth, based on the tolerance that is selected by the control next to the gate drop-down menu. The tolerance is \pm percentage of nadir depth. Right click will increase the tolerance (up to $\pm 90\%$); left click reduces the tolerance.

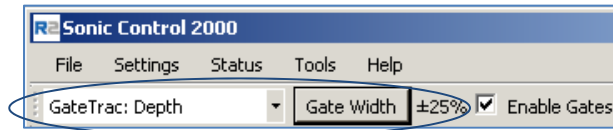

Figure 104: Gate width tolerance toggle

When GateTrac: Depth is enabled, the Gate Min and Gate Max buttons will be disabled, but the Gate Slope button will still be active.

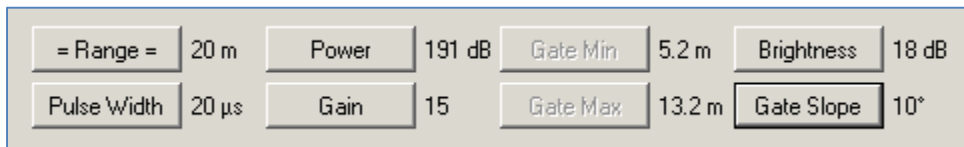

Figure 105: GateTrac enabled; Gate min and max control is disabled

Version	3.3	Rev	r000
Date	13-04-2017		

If the soundings are visible, in the display then, when 'GateTrac: Depth' is enabled, the gates will automatically jump to the soundings, with the selected tolerance. The user can use the Gate Slope button to change the tilt of the gates, they will still automatically track the bottom, and the gate slope will not change from what the user has selected.

5.16.6.3 GateTrac: Depth + Slope

Depth and Slope GateTrac will automatically adjust the gates for the depth and the slope of the bottom. When 'GateTrac: Depth + Slope' is enabled, the Gate Min and Max as well as the Gate Slope buttons will be greyed out.

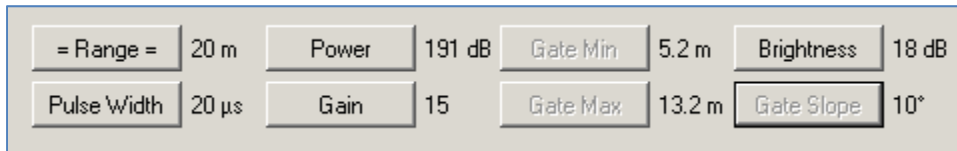

Figure 106: GateTrac: Depth + Slope enabled, manual gate controls are disabled.

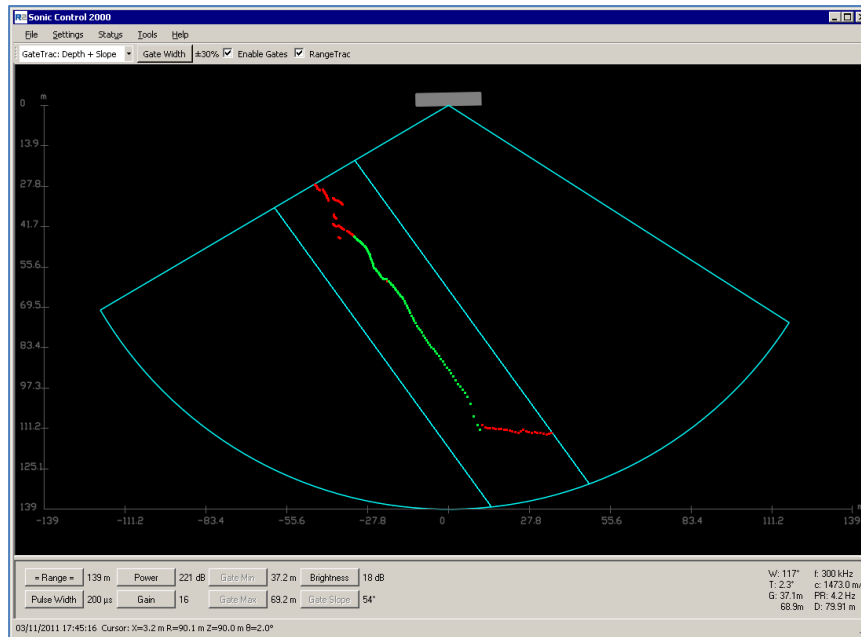

Figure 107: GateTrac: Depth + Slope enabled and tracking a steep slope

5.16.6.4 Using Gates

If the minimum or maximum depth gate eliminates good data, the data are lost as it will not be included in the Sonic 2020 output. In the data collection software there will also be a form of depth gates. If the data are eliminated there, it is more than likely that the data is flagged and not really deleted, so it can be recovered.

Version	3.3	Rev	r000
Date	13-04-2017		

The main reason to use the Sonic 2020 depth gates is to eliminate interference of the bottom detection process. Depending on bottom composition, multiple returns can occur. There will be a secondary and possibly a tertiary return that arises from the initial bottom returns being reflected by the water surface and then back up again to the receiver. These second and third returns can be strong enough to influence the bottom detection process. Using the Sonic 2020 depth gate will enable the Sonic 2020 to search only a small area of the entire beam for a bottom detection, therefore, only the area around where the energy from the actual bottom returns are will be searched to derive a bottom detection. Although the user enters a depth for the gate setting, to the Sonic 2020 this is a time to start searching and a time to stop searching.

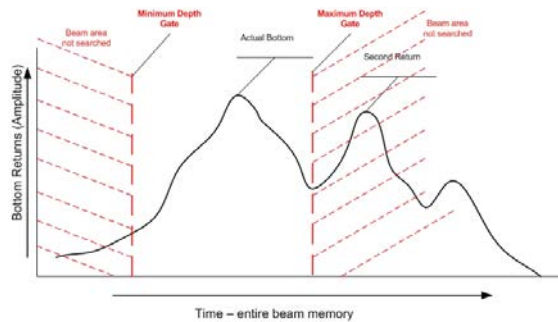

Figure 108: Graphical representation of depth gate

The above representation illustrates how the depth gate narrows down the bottom detection search area (in time) to only the area where the true bottom is expected. If the Maximum Depth gate was not in this location, the second return could be strong enough so as to influence the bottom detection process.

Again, it must be borne in mind that if the depth gate is set such that true bottom detections are 'gated out'; those data are lost entirely and cannot be recovered.

5.17 GUI Rec(ord)

This feature allows the user to record the entire GUI in x.264 format (extension is .mkv). Due to licensing, R2Sonic cannot redistribute the required executables for this format and it is left to the customer to download ffmpeg.exe from <http://ffmpeg.zeranoe.com/builds/>. The ffmpeg.exe file needs to be in the Sonic Control directory or in the Windows search path. To play back the recorded videos there are several free programs that work. MPC-HC <https://mpc-hc.org/> is light-weight (16 MB), supports many formats, excellent scrubbing and launches videos quickly. VLC <http://www.videolan.org/vlc/index.html> is also good, but may take a long time to open a video.

5.18 Ruler

The ruler or measuring tool can be used to obtain range and bearing information, within the GUI, by using the mouse cursor. Use Ctrl + Left Mouse Button (LMB), the cursor will change to a cross and can be dragged to the target (once the range and bearing is initiated, the Ctrl button can be

Version	3.3	Rev	r000
Date	13-04-2017		

released. The Range and Bearing information is along the bottom of the Sonic Control window. To remove the Ruler, use Ctrl + Double Click LMB.

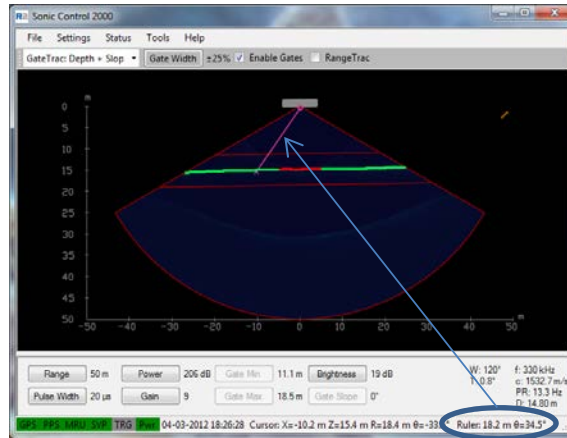

Figure 109: Ruler Function

5.19 Save Settings

When Sonic Control is launched, it will always load the default settings configuration file located in the Sonic Control installation directory (CurrentSettings.ini). The default configuration file will save any local configuration changes during operation of the system.

When a user defined configuration is saved, like dualhead.ini, Sonic Control will still use the default configuration file to store local changes while operating the sonar. This is equivalent to copying the default configuration file to a configuration file with another name.

When a user defined configuration is loaded, Sonic Control will use the default configuration file to store local changes while operating the sonar. This is equivalent to copying the loaded configuration file to the default configuration file.

5.19.1 Default setting ini file

Within the GUI files, there are factory default ini files, which can be loaded to reset the GUI to factory default status. Loading a default settings file has been known to clear some operational issues. When the correct default settings file is loaded, the GUI will need to be set up again by doing Discover and Apply and setting up the Sensor settings

5.20 Operating Sonic Control on a second computer

There may be circumstances where it is preferred to run Sonic Control on a different computer than the computer where the data collection software is running. The user can change IP addresses as well as UDP ports. By doing Discover (in Settings | Network Settings), the system looks for all attached R2Sonic equipment, which will be identified by model and serial number. Once the serial number is discovered, it is used to assign an IP and UDP port to the sonar head and the SIM, after this is done, the IP and UDP ports can be changed.

Version	3.3	Rev	r000
Date	13-04-2017		

5.20.1 Two computer setup

- 1) Set the data collection computer's networking to IP address 10.0.1.102 as usual
- 2) Setup Sonic Control, on the data collection computer, as normal: do Discover and apply the settings to establish communication with the system
- 3) Set the second computer's networking to IP address 10.0.1.105 (using this as an example)
- 4) Load Sonic Control on the second computer, but do not connect the second computer to the SIM until directed to below
- 5) Open Sonic Control on the second computer
- 6) Go to Settings | Network settings and change only the GUI IP address to 10.0.1.105 (see illustration below)
- 7) Connect a LAN cable from the second computer to one of the free RJ45 ports on the SIM (there will now be 2 Ethernet cables connected to the SIM)
- 8) On the data collection computer's Sonic Control, go to Settings | Network Settings and change only the GUI IP to the IP of the second computer: 10.0.1.105 (see illustration below)
- 9) Do not change any other IP or Port, only the IP for the GUI is to be changed
- 10) Select Apply: the GUI, on the data collection computer, will no longer update nor will it be able to control the multibeam
- 11) On the second computer, open Sonic Control
- 12) Under Network settings, use Discover to obtain the serial numbers of the SIM and sonar head and Apply; this computer now controls the Sonic system.
- 13) This example used IP address 10.0.1.105, but any IP can be entered as long as it adheres to the restrictions set by the subnet mask

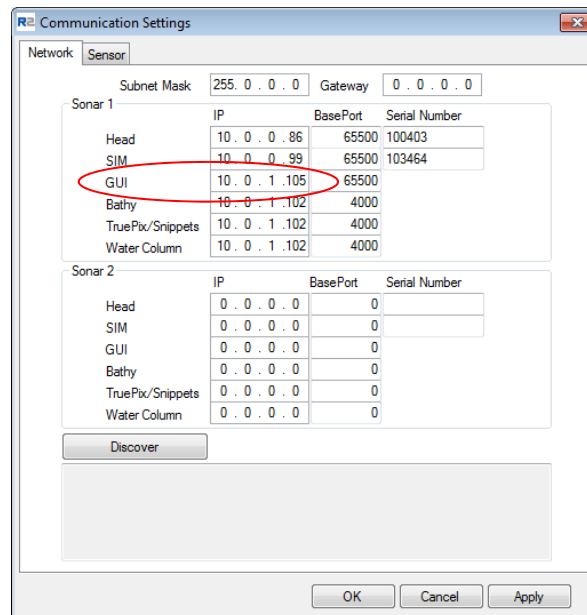

Figure 110: Change in GUI IP

5.20.2 Changing back to one computer

- 1) Open Sonic Control on the data collection computer.
- 2) Change the GUI address to 10.0.1.102
- 3) On the second computer, change the GUI IP address back to 10.0.1.102 and Apply.
- 4) Sonic Control, on the data collection computer now controls the system.

Disconnect the second computer's Ethernet cable from the SIM.

Version	3.3	Rev	r000
Date	13-04-2017		

6 SONIC 2020 THEORY OF OPERATION

The Sonic 2020 transmits a shaped continuous wave pulse at the user- selected frequency. The transmit pulse is narrow in the along-track direction, but very wide in the across-track direction. The reflected acoustic energy is received via the Sonic 2020 receivers; within the Receive Module the beams are formed and the bottom detection process takes place. The resultant bottom detections (range and bearing) are then sent via Ethernet, through the deck lead, to the SIM. The SIM then sends the data out to the Sonic Control software and the data collection software.

6.1 Sonic 2020 Sonar Head Block Diagram

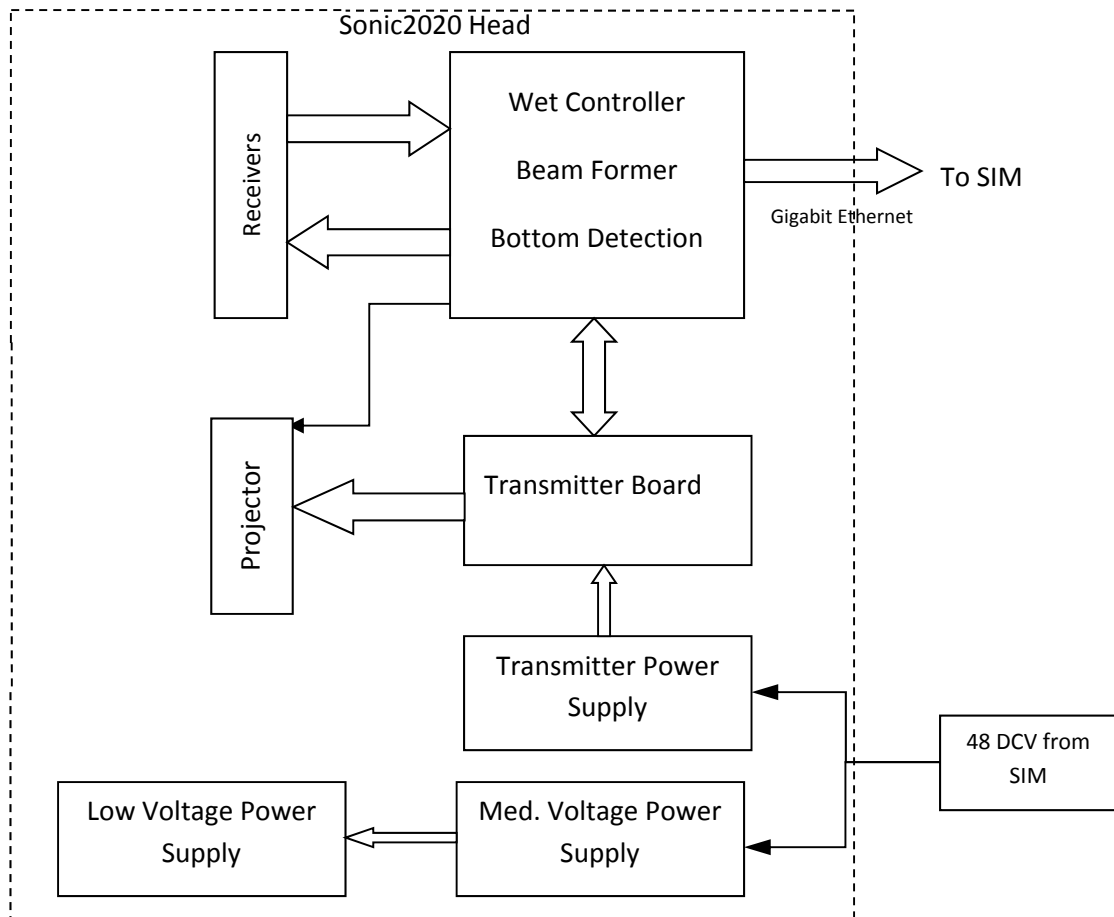

Figure 111: Sonic 2020 Sonar Head Block Diagram

6.2 Sonic 2020 Transmit (Normal Operation Mode)

The projector is comprised of a precisely arranged set of composite ceramics. The projector, itself, can transmit over a wide frequency range, which makes it unique amongst multibeam echosounders. A pulse, at the chosen operating frequency, excites the ceramics which converts the electrical energy to acoustic energy. The pulse originates from the Wet Controller board in the Receive Module, which is then passed onto the Transmitters and out to the Projector. The amplitude of the pulse is set by the transmit Power setting in Sonic Control 2000; the Pulse Length setting in Sonic Control 2000 determines how long the pulse excites the ceramics.

The projector's transmit pattern ensonifies the seafloor in a very wide across-track, but narrow along-track pattern as the vessel moves along the survey line. The across-track angle is 130°; the along-track angle depends on frequency. The 400 kHz along-track pattern is 1°. The along-track lengthens out to 2° at 200 kHz. This is the Normal Operating Mode and not extended Vertical Mapping Mode.

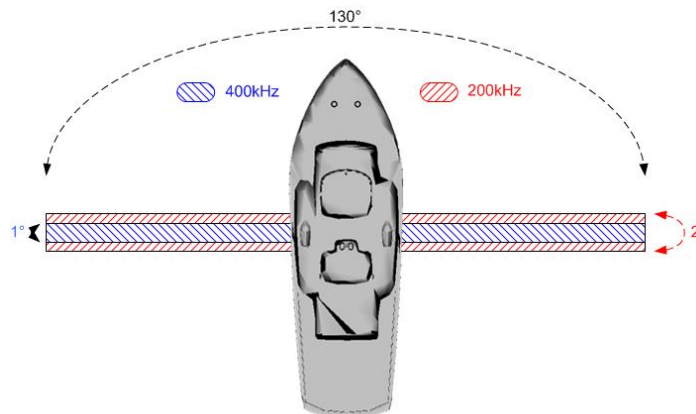

Figure 112: Transmit pattern

Depending on the water conditions, sea floor composition and other factors, a portion of the acoustic energy that strikes the seafloor will be reflected back towards the surface. The return acoustic energy will strike the Sonic 2020 receiver's ceramics.

Version	3.3	Rev	r000
Date	13-04-2017		

6.3 Sonic 2020 Receive (Normal Operation Mode)

The Projector is comprised of composite ceramics that convert electrical energy to acoustic energy. The composite ceramics, in the Receive Module, convert the reflected acoustic energy back to electrical energy. The small electrical voltage, generated by the ceramics, is amplified and then passed onto the receivers. The output of the receivers goes directly to the Wet Controller board in the Receive Module.

In general, the receive pattern is 130° (normal bathymetry survey) in the across-track. The along-track pattern depends on the frequency; from 23° at 400 kHz to 40° at 200 kHz.

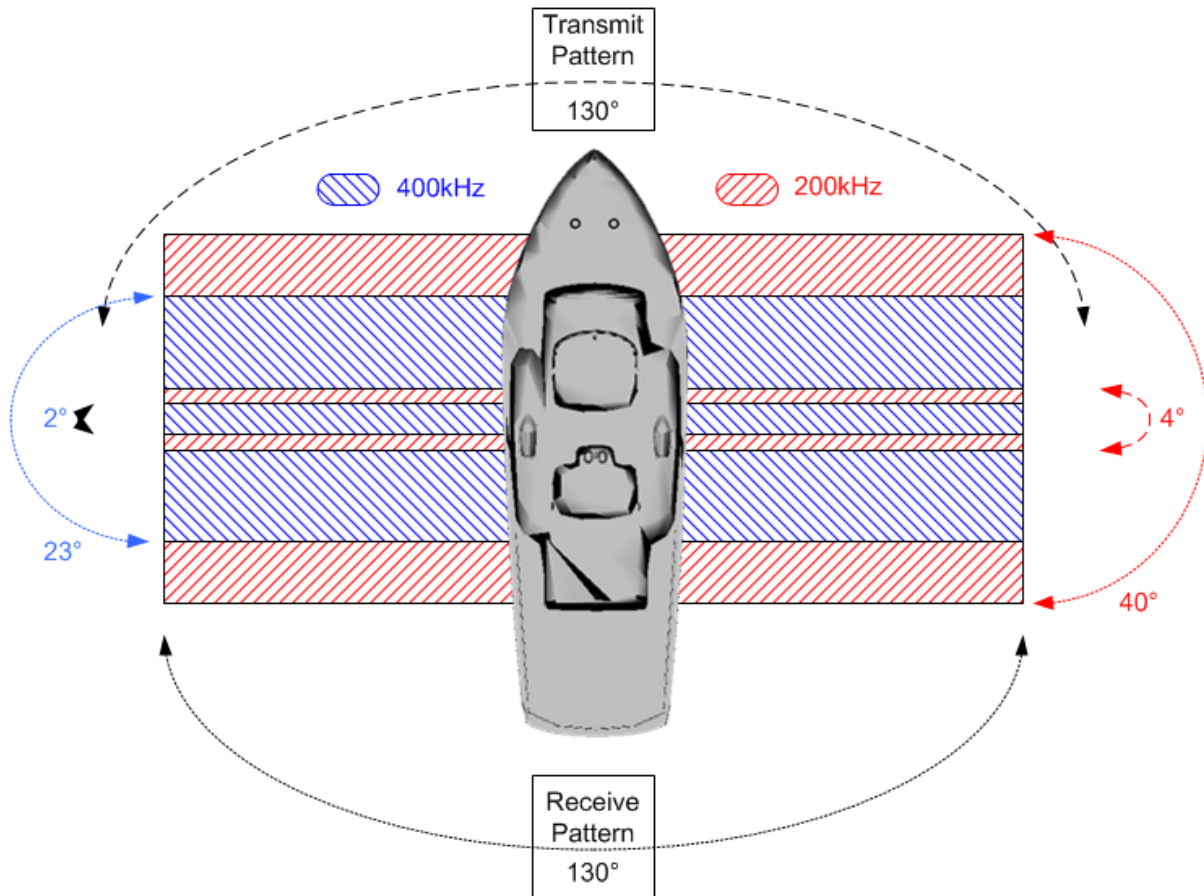

Figure 113: Receive pattern with Transmit pattern

The Wet Controller board contains the FPGA that performs the beam forming and bottom detection operation; time tags the data; and formats the sonar data for output back up to the SIM. The bathymetry data is output as a Range and Bearing (from the sonar head's acoustic centre) for each beam. Other outputs include: side scan, beamformed imagery, and Snippets.

The output of the Wet Controller board is sent through the deck lead, to the SIM's Gigabit switch and onto the data collection computer through one of the SIM's external RJ45 connections.

Version	3.3	Rev	r000
Date	13-04-2017		

6.4 Sonic 2020 Sonar Interface Module (SIM) Block Diagram

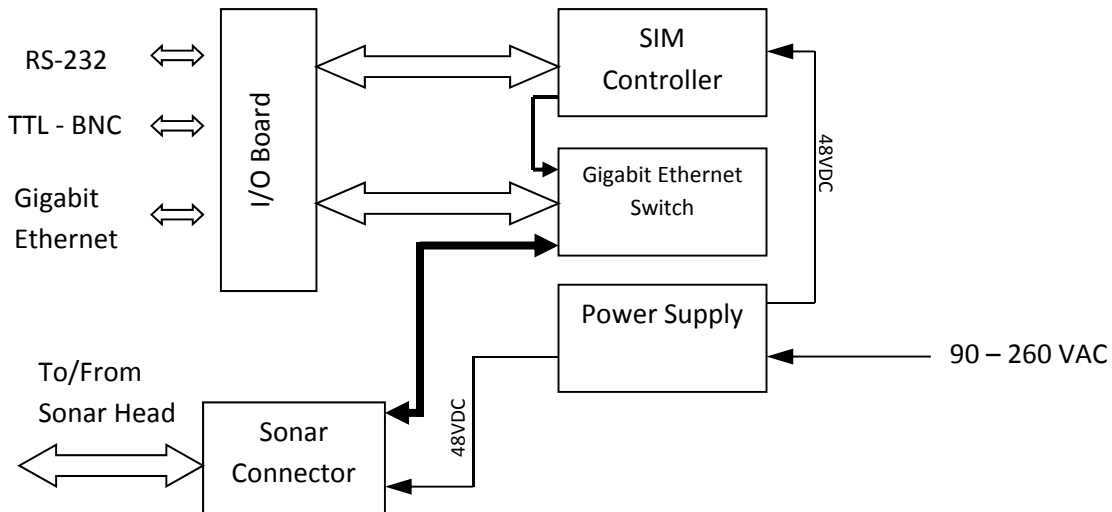

Figure 114: Sonar Interface Module Block Diagram

6.4.1 Sonar Interface Module (SIM) Block Diagram

6.4.1.1 SIM Power Requirement

The SIM operates within a voltage range of 90 to 260 VAC. The mains voltage is converted in the various DC voltages required for the operation of the Sonic 2020. Primarily, 48 VDC is sent to the Receive Module to power the sonar head.

6.4.1.2 SIM Controller

The SIM Controller card primarily does time stamping of sensor data and deals with RS-232 and BNC data.

6.4.1.3 SIM – Sonic Control 2000 interfacing

Sonic Control 2000 communicates with the SIM over the Gigabit Ethernet DATA RJ-45. Commands, from Sonic Control 2000 are transmitted to the SIM and then to the Sonic 2020. The Sonic 2020 data passes through SIM to the data collection software.

6.4.1.4 SIM – RS-232 / Ethernet Interfacing

The SIM receives the GPS PPS and time message (NMEA ZDA), the sound velocity from the probe near the sonar head and the motion sensor data (for roll stabilisation only). These data are routed through the SIM Controller to the Ethernet switch for transmission to the sonar head.

Version	3.3	Rev	r000
Date	13-04-2017		

Appendix I R2Sonic I2NS™

7 Appendix I: R2Sonic I2NS Components and Operation

The R2Sonic I2NS (Inertial Navigation System) option integrates the Applanix Position and Orientation System (POS/MV)'s POS Computing System (PCS) and Sonar topside units saving both power and space while simplifying vessel mobilization. The setup of the R2Sonic INS is identical to the setup of the Applanix POS/MV system; POSView (Version 7.60 or more recent) is necessary for inputting offsets and configuring outputs. All of the data, both sonar and POS/MV are sent over the one Ethernet cable to the data collection computer; eliminating the need for two network cards. The information contained here does not detail the POSView software to set up the Applanix POS/MV; that information is found in the Applanix POS/MV manual. The information provided here covers the necessary setup of the R2Sonic I2NS components as relates to the R2Sonic SIM and Sonic Control. Where necessary, certain steps in the POSView software are detailed.

The R2Sonic INS will work on all R2Sonic systems with SIM firmware: *Simb\$26-OCT-2013-15-58-27.bin* and head firmware: *Head\$16-Nov-2013-04-35-57.bin* or more recent.

7.1 Components

The R2Sonic I2NS is comprised of the enhanced Sonar Interface Module (SIM), which contains the Applanix boards and connections for the antennas and Inertial Measurement Unit (IMU). Two antennas (and cables) and one IMU (and cable) complete the physical INS components.



Figure 115: R2Sonic I2NS Main Components (not including antennas and cables)



Figure 116: GNSS Antennas

Version	3.3	Rev	r000
Date	13-04-2017		

Part No. 96000005

7.2 Mounting the IMU on the Sonic 2020 mounting frame

The Sonic 2020 mounting frame has been designed to accept the IMU for those customers that prefer to have the IMU mounted on the sonar head.



Figure 117: IMU mounted within the Sonic 2022 mounting frame

The same bolts are used to secure the Sonic 2020 to the mounting frame and the IMU. The bolts pass through the face of the 2020 to the mounting frame. The IMU is then placed over the same bolts and secured. The isolation grommet goes over the bolt first, then the ring washer, the split or lock washer and then the bolt.



Figure 118: Detail of securing IMU and Sonic 2020

Version	3.3	Rev	r000
Date	13-04-2017		

The IMU cable is passed through the flange in the same manner as the decklead and SV cable. The connection is made on the rear of the IMU. Care must be taken that the IMU cable is not bent more than as seen below; do not pull the IMU cable taut.



Figure 119: Aft detail of the IMU cable connection

7.3 Installing the IMU and GPS antennas

The IMU (Inertial Measurement Unit) housing should be secured by 4 M8 screws.(3/8" in Imperial units). The IMU housing is depth rated to 15m. The IMU can be mounted close to or on the Multibeam transducer itself. It is not necessary to mount the IMU at the vessel's CoG (centre of gravity), **but if it is not mounted on the CoG, it is vitally important that very accurate IMU to CoG offsets are input into POSView.**

The GNSS antennas should be mounted rigidly with respect to each other as well as the IMU, with a separation of at least 1m between the GPS antennas. The antennas should be mounted so that they have a clear view of the sky.

The standard cables provided with the INS option are:

- 1x15m IMU cable
- 1xBNC jumper cable
- 2x8m GPS antenna cables

Version	3.3	Rev	r000
Date	13-04-2017		

Part No. 96000005

7.4 Connection diagram

When using the INS, there is no need to provide inputs for the motion or the time stamp, as those are provided internally, through the SIM's Gigabit switch. The only serial connection is the sound velocity probe that is on the sonar head. A PPS loop cable is required to go from the PPS out to the PPS in. The IMU can be mounted within the Sonic 2020 mounting frame or can be placed at vessel's centre of rotation.

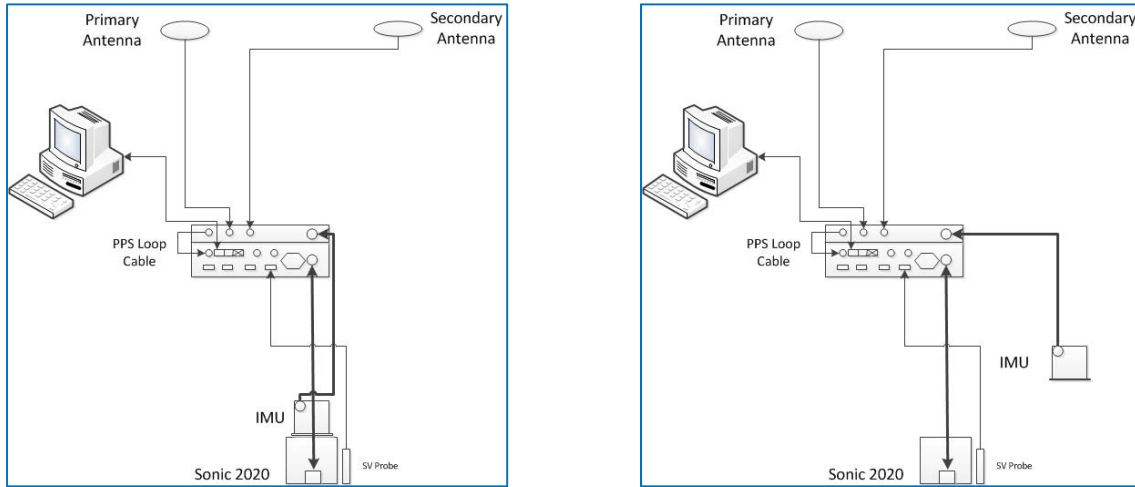

Figure 120: INS connections

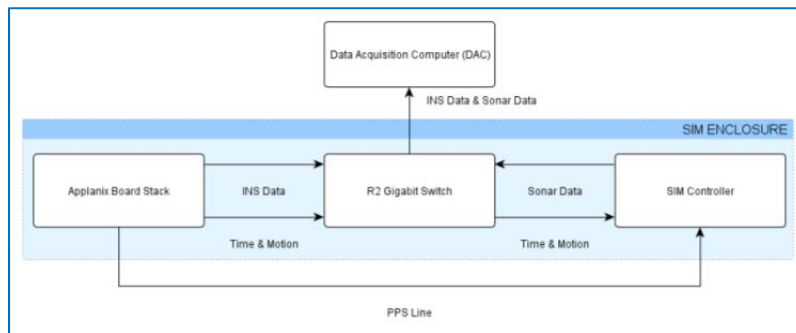

Figure 121: INS SIM block diagram

Version	3.3	Rev	r000
Date	13-04-2017		

7.4.1 INS BNC – TNC Connections



There is one BNC connection for the PPS out. The TNC connection next to it is for the Primary Antenna. The Secondary antenna connects to the TNC connection on the end.

Figure 122: INS BNC & TNC Connections

The PPS Out is connected to the SIM PPS In, with a short length of cable (provided).



Figure 123: PPS Out - PPS In

7.4.2 I2NS DB9 Connections

The I2NS has two serial communication ports. These are standard DB9M serial connections that are setup in the POSView software. Both ports are bi-directional and can be configured to receive RTCM corrections or to output standard NMEA or binary serial data. For full information on the serial ports, please refer to the POSView documentation.



Figure 124: Com 1 and Com 2

In POSView, in the Input/Output Ports Set-up, only COM 1 and COM 2 are to be configured.

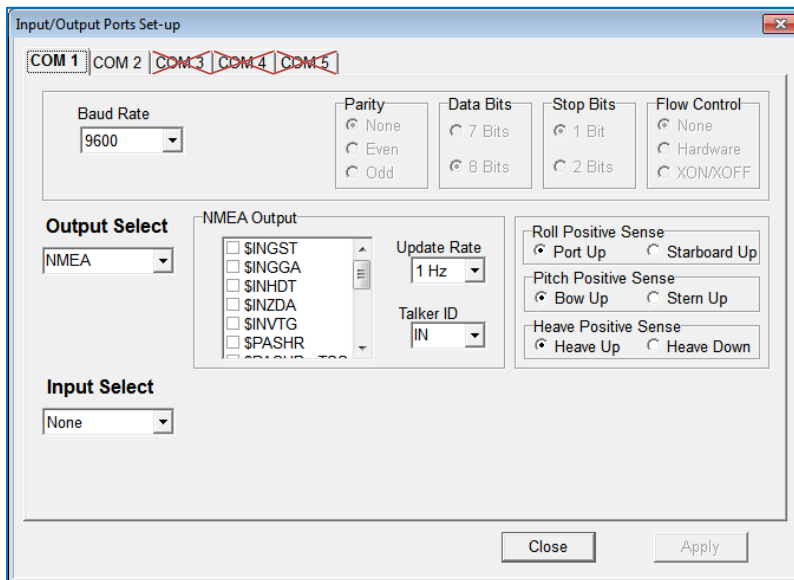

Figure 125: POSView Serial port setup

Version	3.3	Rev	r000
Date	13-04-2017		

7.5 Setup in Sonic Control

7.5.1 Network Setup

In the event that the Applanix IP address is lost and no connection can be made through POSView it can be reset through the R2Sonic GUI. To change the IP address of the POS/MV, reboot the SIM box, open the R2Sonic GUI and go to Settings>Network Settings and under “INS IP” enter the desired IP. The POS/MV takes approximately 2 minutes to power on, once the POS is fully booted, the IP can be set in the R2Sonic GUI. Once the POS is fully booted the user has 5 minutes to change the IP address of the POS/MV. Attempting to change the IP address, outside of the 5 minute window, will result in a warning that the SIM box must be rebooted before changing the INS IP.

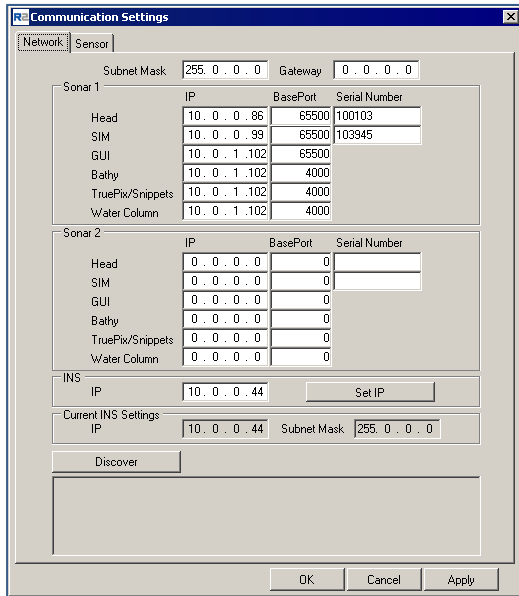

0 minutes: turn on

0 to 1min: Button label is "Set IP wait" and button text is greyed out. The INS IP cannot be updated during this period. The GUI is waiting for the INS to send out message 32.

After ≈ 1 - 2 mins: the GUI will allow changes to the INS IP address. The actual time depends on when the GUI starts receiving message 32 from the INS.

From ≈1min (2min) to 7min: INS IP address can be changed. Button text turns from greyed out to black text and says "Set IP".

After 7 min: INS won't accept change in IP address. Button text color is greyed out and label says "Set IP expired".

Figure 126: Network Settings SIMINS

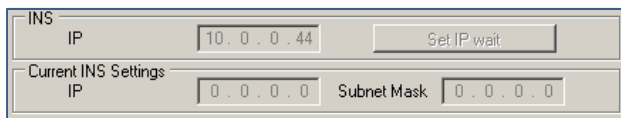

Figure 127: Cannot Change IP, waiting on msg 32

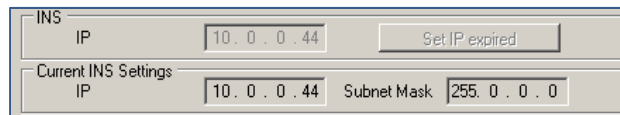

Figure 128: Set IP time expired, cannot change IP

7.5.2 Applanix Group 119 specific to R2Sonic SIMINS

Src: 10.0.0.44:65533

Dst: 10.255.255.255:5606

Applanix POS, Customer data

```

Group 119 (MV customer defined group)
Group start: $GRP
Group ID: 119 (MV customer defined group)
Byte count: 132
Time/Distance Fields:
Time 1: 358370.467027857 (UTC seconds of the week) (Thu 03:32:50.467028 UTC)
Time 2: 1091.53761465444 (POS seconds since power-on) (0.303205 hours)
Distance tag: 0 (POS distance)
Time types: 0x02
Distance type: 0x01
User ID: 1
Reserved: 00
PacketName: R2A0
PacketSize: 100
Reserved0: 0000
PpsTime: 358386 (GPS seconds of the week) (Thu 03:32:50.000000 UTC) (1395286370 Unix)
VesselLatitude: 30.2391284856087 (degrees)
VesselLongitude: -97.838843091206 (degrees)
VesselAltitude: 198.64372053742 (meters)
North position RMS error: 0.922135 (meters)
East position RMS error: 0.698561 (meters)
Down position RMS error: 1.10037 (meters)
VesselPitch: 0.00230865 (radians) (0.132276 degrees)
VesselRoll: 0.000915637 (radians) (0.052462 degrees)
VesselHeave: 0.0256301 (meters)
VesselHeading: 0.115629 (radians) (6.625050 degrees)
RmsErrorPitch: 0.0292523 (degrees)
RmsErrorRoll: 0.0292523 (degrees)
VesselSpeed: 0.063469 (meters/second)
RmsErrorHeading: 10.2586 (degrees)
GpsWeekNumber: 1784 (GPS weeks)
UTCTimeOffset: 16 (GPS-UTC seconds)
StatusB: 0x0189200d
StatusC: 0x00001000
StatusExtended: 0x00000100
Satellites: 9
Reserved1: 00
Reserved2: 0000
Checksum: 23896 (Good)
Group end: $#

```

Version	3.3	Rev	r000
Date	13-04-2017		

7.5.3 Sensor Setup

All of the required information (time message and motion data) from the INS stack, except for the PPS, is transferred internally. However, in the Sensor setup the Interface type and Ethernet configuration has to be set up to receive the internal information. The GPS and Motion interface type is set to Ethernet. The IP that the POS/MV stack sends data out is 10.0.0.44 and uses UDP port 5606, which is unique for R2Sonic requirements. **The POS/MV Ethernet data, going to the data collection computer, is on the same IP (10.0.1.102), as the sonar data and uses the standard POS/MV UDP 5602. If the data collection software requires the IP address of the 'talker', the POS/MV stack outputs on IP 10.0.0.44.**

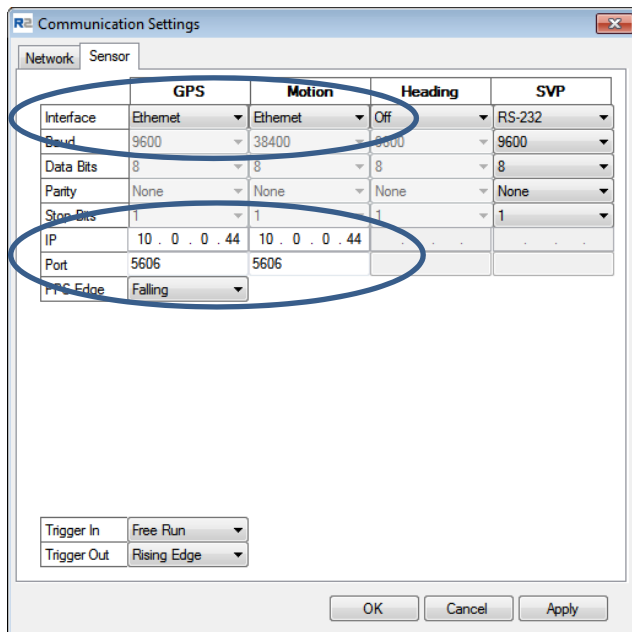

Figure 129: Sensor setup SIMINS

7.5.4 INS Monitor (Alt+I)

INS data can be monitor through the INS monitor. The INS monitor option is under Status.

INS Monitor		
Latitude	30.23915662° +/-	1.383m
Longitude	-97.83881809° +/-	1.380m
Altitude	208.961m +/-	2.417m
GNSS Fix Status: Pri. GPS configuration file sent		
Speed	0.048 knots	
Roll	-0.195° +/-	0.038°
Pitch	-0.157° +/-	0.038°
Heading	96.349° +/-	15.776°
Heave	-0.182m	
GAMS	Not ready	
# of satellites	10	

The INS Monitor allows the user to constantly monitor the values from the INS.

The accuracy limits are preset and independent of the settings in POSView:

Roll & Pitch:	0.050°
Heading:	0.050°
Latitude/Longitude:	2.000m
Altitude:	2.000m

Figure 130: INS Monitor

Version	3.3	Rev	r000
Date	13-04-2017		

7.6 Measuring IMU Offsets

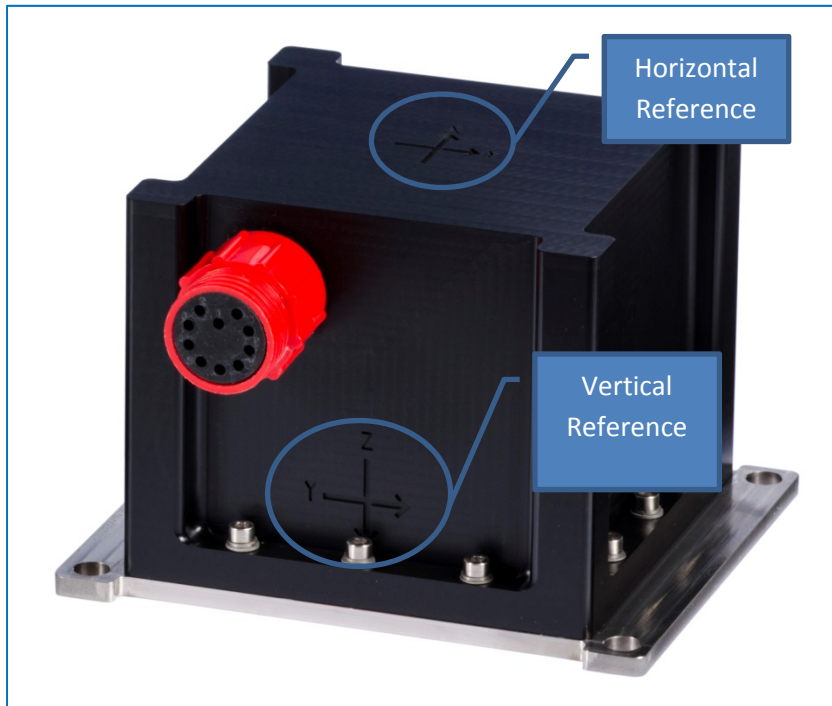

Figure 131: IMU Reference indicators

Identify the COG of the vessel that point becomes the reference point of the INS offsets. The POS/MV uses a right-hand Cartesian co-ordinate system therefore the lever arm offsets should be measured as

- +X = To Bow
- +Y = To Starboard
- +Z = Down

When using DGPS offsets should be measured to 5cm accuracy. When using RTK offsets should be measured to 5mm accuracy.

Measure the offset from the reference point to the primary GPS antenna and record it in POSView in the **“ref. to Primary GPS Lever Arm”** fields. There is no need to measure the offset of the second antenna; the Applanix GAMS calibration will determine this X offset.

Measurement of the IMU COG is critical. The IMU has two reference points. On top of the IMU is the horizontal reference for the X and Y measurement. The vertical Z reference is measured to the reference point on the rear part of the IMU. After measuring the reference to IMU offsets, input the values in the **“Ref. to IMU Target”** fields in POSView Be sure to check the box by **“Enable Bare IMU”**, as seen below. NOTE: Some older versions of POSView will not have this option. If not, please install the version preloaded on the R2Sonic CD that shipped with the Sonar.

Version	3.3	Rev	r000
Date	13-04-2017		

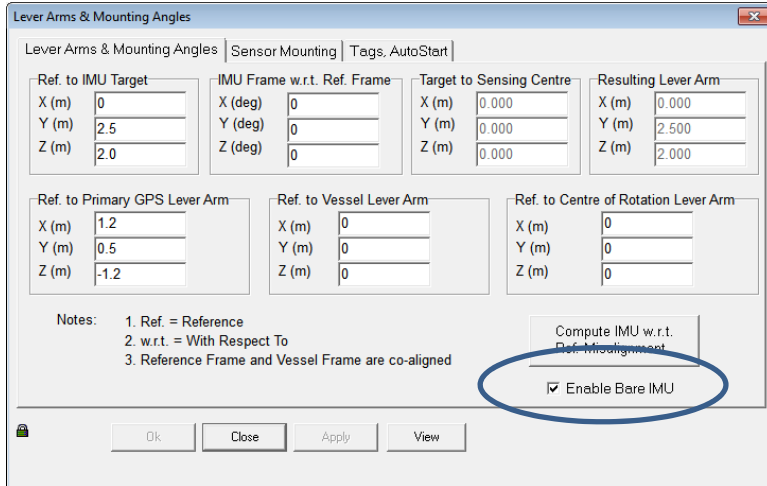

Figure 132: POSView Lever Arm setup

Use the View, when entering offsets, so that the correct sign is confirmed. This figure represents the physical installation using the offsets that are seen in the above figure.

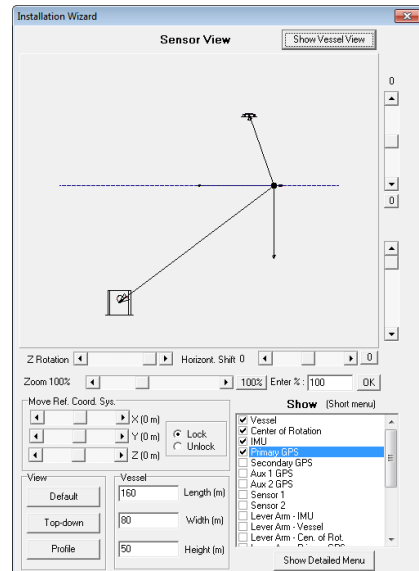

Figure 133: View of installation with the entered offsets

If the Reference point chosen is NOT the COG of the vessel input the offsets from the ref to the COG in the **“Ref. to Centre of Rotation”** fields. This step is extremely important for accurate heave information to be reported.

7.7 Sonic 2020 and IMU offsets when mounted

The Sonic 2020 mounting frame is designed so that the IMU can be installed in the same frame and uses the same bolts to secure both the Sonic 2020 and the IMU. This closely couples the two instruments to each other. Horizontally, the Sonic 2020 acoustic centre and the IMU reference points are in close agreement, but do not coincide with each other.

7.7.1 Vertical Relationship

The Sonic 2020 vertical reference is 168.6mm below the IMU vertical reference

IMU Z to mounting plate = 30.6mm (1.2 inches)
 Mounting plate thickness ≈ 7mm (0.276 inches)
 Bottom of mounting plate
 To Sonic 2020 Z reference = 131.0mm (5.16 inches)
 168.6mm (6.64 inches)

IMU Z Ref to 2020 Z Ref = 168.6mm (6.64 inches)
Top of mounting frame to IMU Z reference = 114.3mm (4.5 inches)
Top of mounting frame to 2020 Z reference = 282.9mm (11.14 inches)

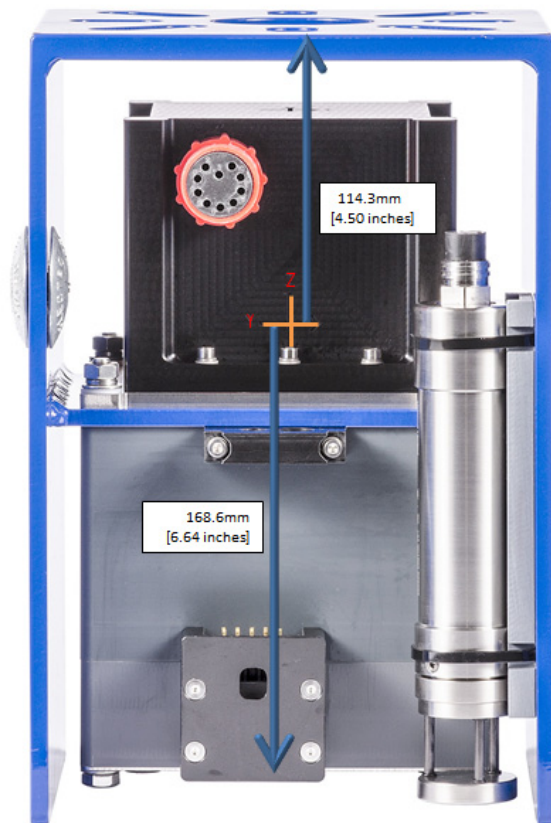

Figure 134: 2020-INS Vertical Offsets

Version	3.3	Rev	r000
Date	13-04-2017		

7.7.2 Horizontal Relationship

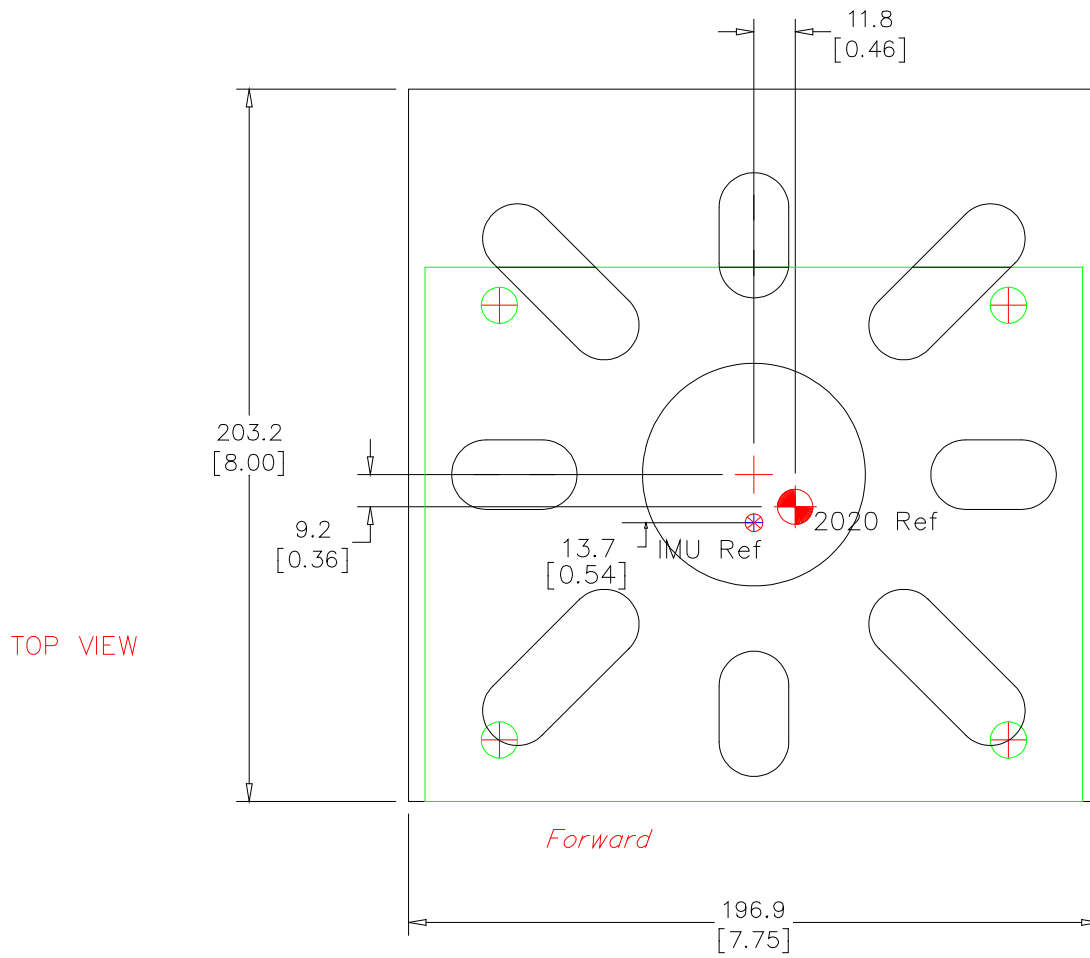

Figure 135: 2020 INS Horizontal Offsets

Version	3.3	Rev	r000
Date	13-04-2017		

7.8 I2NS Physical Specifications

Table 10: I2NS Dimensions and Mass

Component	Dimensions (L x W x H) / Mass
I2NS Sonar Interface Module (INS-SIM)	280mm x 170mm x 126.4mm (top of cooling fins) / 4.17kg
Inertial Measurements Unit (IMU)	161mm x 140mm x 110m / 2.2kg
GNSS Antenna	∅178mm x 73mm / 0.45kg

Table 11: Electrical Specification

Item	Specification
INS (SIM, IMU & Antennas)	38.4w
INS + Sonic 2020	59.6w

Version	3.3	Rev	r000
Date	13-04-2017		

7.9 I2NS Drawings

7.9.1 I2NS IMU

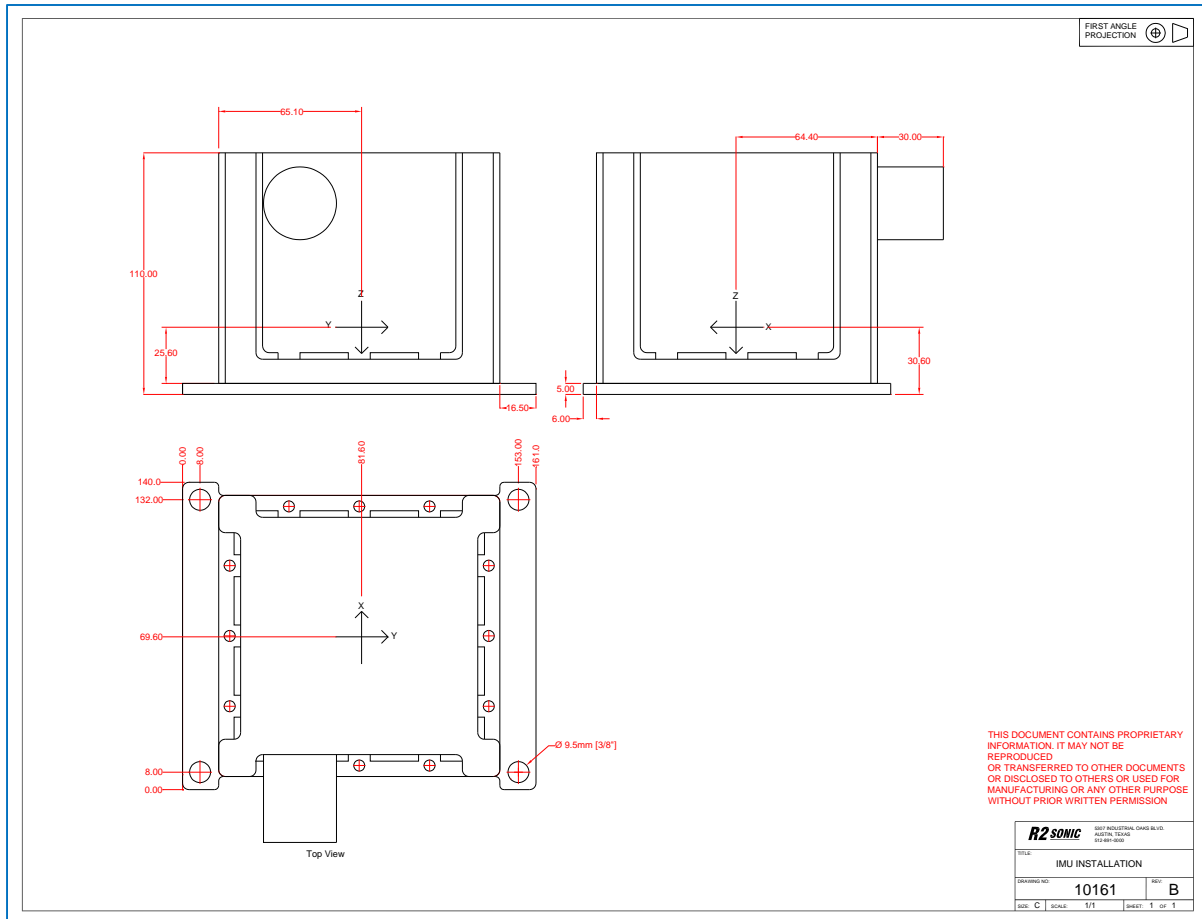

Figure 136: IMU Drawing

Version	3.3	Rev	r000
Date	13-04-2017		

Part No. 96000005

7.9.2 I2NS Sonar Interface Module (SIM)

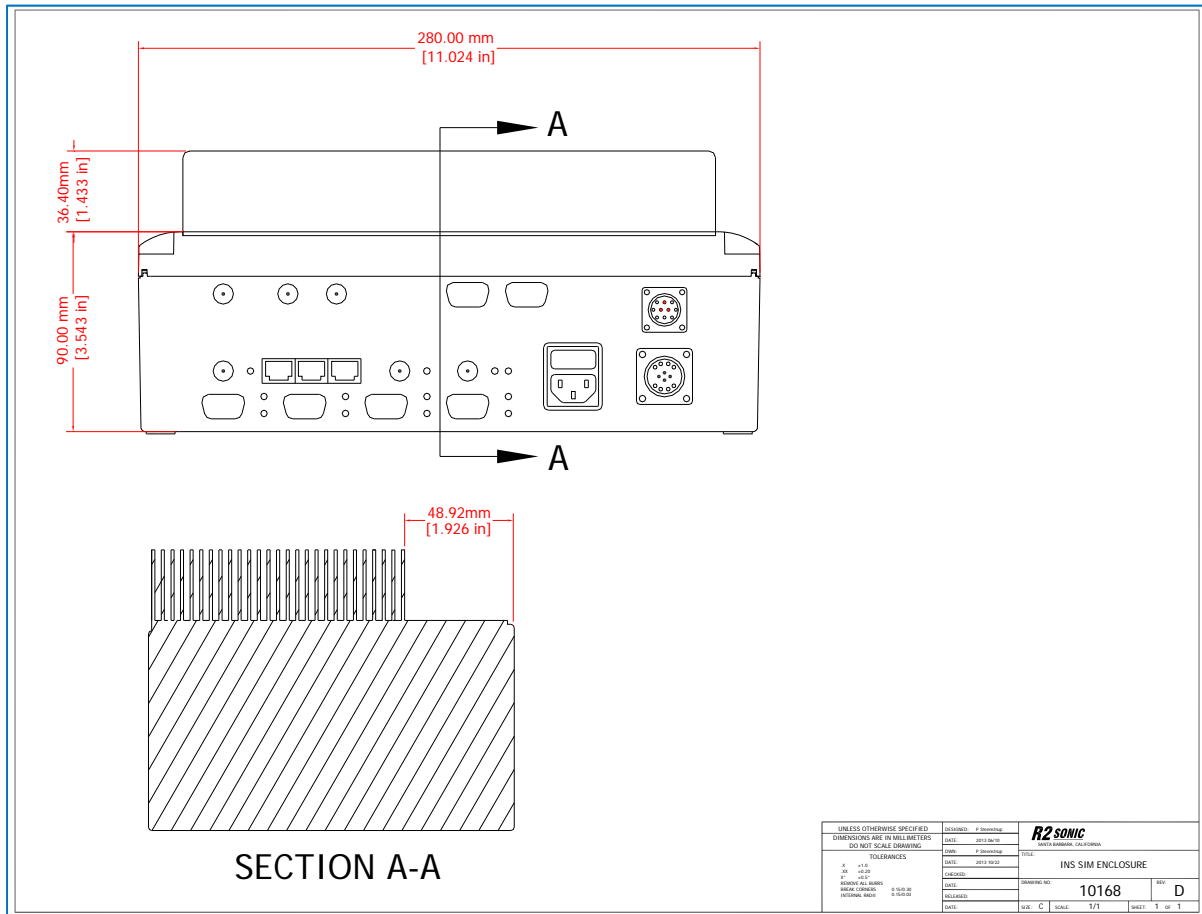

Figure 137: I2NS SIM Drawing

Version	3.3	Rev	r000
Date	13-04-2017		

Version	3.3	Rev	r000
Date	13-04-2017		

Part No. 96000005

APPENDIX II: Multibeam Survey Suite Components

8 APPENDIX II: Multibeam Survey Suite Components

8.1 Auxiliary Sensors and Components

A multibeam survey system is comprised of more components than just the Sonic 2020 Multibeam Echosounder. These components are the auxiliary sensors, which are required to provide the necessary information for a multibeam survey. This does not mean that these sensors are a minor part of the survey system; each auxiliary sensor is required for any multibeam survey operation. The required sensor data:

- Position: Differential Global Positioning System Receiver
- Heading: Gyrocompass
- Attitude: Motion Sensor
- Refraction correction: Sound Velocity Probe

Each of the individual sensors requires their own setup and operation procedures. The details, discussed here, concerning the installation and calibration of the auxiliary sensors, is supplemental to any and all manufacturer’s documentation.

8.2 Differential Global Positioning System

The Global Positioning System (GPS) is well known to all surveyors. There was a period of time when the GPS position was intentionally made less accurate; this was Selective Availability (SA). When SA was enacted, the GPS position became too inaccurate for survey use. It was during this period that the concept of differential corrections was established. Differential corrections were derived from users monitoring the GPS position at a known survey point and computing the corrections required to adjust the various pseudo ranges to make the GPS position agree with the known survey position. If a vessel was operating within the local area and observing the same satellite constellation, the derived pseudo range corrections could be applied on board to make for a more accurate and consistent position. The corrections are normally transmitted over a radio link and applied within the GPS receiver.

8.2.1 Installation

The first and foremost consideration when installing the DGPS system is the location of the respective antennae. Both the GPS antenna and the differential antenna (if they are two separate antennae) need to be mounted on the vessel in such a way so as to have a totally unobstructed view of the sky.

Version	3.3	Rev	r000
Date	13-04-2017		

When installing the GPS antenna, the surveyor should be aware of the position of the stacks and masts; in particular are davits or cranes that may be currently in a stored position, but will be in use during survey operations. If mounting the antenna on a vessel that has helicopter landing facilities, coordinate the placement of the antenna with the personnel in charge of helicopter operations.

When the location for the antennae has been determined the next step is determining how the coaxial cable, connecting the antenna and the receiver, is to be run. The cables should be run in such a manner so as to be protected from possible damage. Cables should not be run through hatches or windows, if it can be avoided; if such runs are necessary, then a block or other such obstruction should be placed so that the hatch or window will not close on the cable. If the cables are to be suspended between two points, a rope or other line should be strung to carry the weight of the cables. Cables should never be kinked; all cables have a minimum bending radius, if it is known adhere to it, if it is not known, use common sense. Do not run cables in a manner that they will become safety hazards on the vessel, causing personnel to trip or be caught on them. Avoid running cables along voltage carrying lines.

It is important to mark the cables at both ends to denote what they are and to where they go.

The connection to the antenna may be required to be completely water proofed (depending on the manufacturer’s recommendations) using electrical tape, with a secondary covering of self-amalgamated tape. Ensure that there are no air gaps in the tape; they will become a channel for water. If a cable is to be run upwards from the antenna, form a drip loop by leaving slack in the cable that will hang below the antenna connector. This will allow any water that flows down the cable to collect and drip from the slack loop instead of running into the connector.

The cables, connectors and antennae should be inspected regularly for signs of damage, corrosion or abuse. Any abrasions on the cable should be securely taped; if possible, a waterproof coating should also be applied.

8.2.2 GPS Calibration

Prior to commencing survey operations, the accuracy of the Differential GPS position and transformation to local datum should be determined. There are two main methods to determine the accuracy of the DGPS position and data transformation. For both methods, a local land survey benchmark is required.

8.2.2.1 Position Accuracy Determination Method 1

The GPS antenna is physically placed over the survey benchmark. The surveyor will ensure that the antenna has a clear view. This is particularly important if the benchmark being used is in a dock area. The surveyor will also ensure that, if a separate antenna is used to receive differential corrections, that it is not blocked.

The GPS position data should be logged, in the data collection software, for not less than 15 minutes. The collected data can then be averaged, standard deviations determined, and compared to the published position of the survey benchmark.

Version	3.3	Rev	r000
Date	13-04-2017		

The two main causes of error, in this area, are:

- Wrong geodetic transformations being applied to the WGS-84 position derived from GPS.
- Erroneous coordinates for the Differential reference station.

8.2.2.2 Position Accuracy Determination Method 2

This method is most easily accomplished during the gyrocompass calibration. The antenna remains mounted on the vessel. The surveyor will set up on the known survey benchmarks; using standard land survey techniques, the exact absolute position of the antenna can be determined. During the period that the surveyor is ‘shooting in’ the GPS antenna, the GPS position will be logged on board, the averaging and statistical analysis will be as above.

The surveyor will need to take numerous shots to also obtain an average, due to the possible movement of the vessel while alongside.

8.3 Gyrocompass

Utmost care is required for the installation of the gyrocompass. The gyrocompass is a sensor that cannot be situated randomly. The purpose of the gyrocompass is to measure the vessel’s heading. In order to do this, the gyrocompass should be placed on the centre line running from the bow stem to the midpoint of the stern. If it is not possible to place the gyrocompass on the centreline of the vessel, it can be mounted on a parallel to the centre line.

All survey grade gyrocompasses will be plainly marked for alignment on the centre line. This marking may be an etched line fore and aft on the mounting plate, or possibly metal pins on the front and the back of the housing that point down. If no marking exists, then measuring the fore and aft faces and finding the centre may be sufficient.

No matter how well the gyrocompass is placed, there exists a possible error between the true vessel’s heading and the gyrocompass derived heading. Any new installation of a gyrocompass should include a gyrocompass calibration. There are various methods to perform a gyrocompass calibration; the best method employed will be determined by the location of the vessel, the time allotted for the calibration and the resources at hand.

8.3.1 Gyrocompass Calibration Methods

After the installation of gyrocompass (henceforth termed gyro) on a vessel, that gyro should be calibrated to ensure that the heading it determines is the true heading of the vessel.

If the error is large, the gyro can be physically rotated to align itself with the true vessel heading. Small errors can be corrected, either by internal adjustment to the gyro, or in the software that receives the gyro reading.

Version	3.3	Rev	r000
Date	13-04-2017		

8.3.1.1 Standard Land Survey Technique

One of the most accurate methods to determine the gyro error involves the use of standard recognised land survey techniques. The time and equipment involved requires that a substantial period be allotted for such a calibration.

- If possible, the vessel will be berthed alongside a quay or dock that has a survey benchmark located in close proximity.
- If a survey benchmark is not located close to the berth, then the surveyor will have to run a transit from the nearest, suitable, local survey bench mark to establish a point on the quay that has a well-defined position. From this point another point should be established along the quay to form a baseline.
- When the vessel comes alongside, all lines should be made as taut as possible. The gyro should be allowed 2 hours to settle down after the vessel has come alongside.
- The stern of the vessel should be measured, with a metal tape, to determine the centre point of the stern. A survey reflector will be placed at this position. Another survey reflector will be placed exactly at the bow. It will be verified that the reflectors are accurately placed on the centre line of the vessel by either measurements or survey techniques.
- The surveyor will set up on one benchmark; a round of readings will be taken from the benchmark to the fore and aft reflectors. Simultaneous to this, the survey personnel will record the gyro heading as it is read by the survey computer. Any variation between the digital output and the physical gyro reading should be remedied prior to the commencement of readings. It is recommended that the personnel on the vessel and the surveyors on the quay be in constant communication to assist in coordinating the measurements.
- One round of readings will be considered to be not less than 30 sets, a set being one reading each from the bow and stern reflectors.
- Upon completion of the round from benchmark one, the surveyor will move to benchmark two and repeat the process.
- Upon the completion of all rounds, from the two benchmarks, the vessel will turn about. With the vessel, now heading on the reciprocal heading, the gyro will be allowed at least 1 hour to settle down.
- When the gyro has been given sufficient time to settle down, a further series of range and bearing measurements will be made in exactly the same manner as before.

When all readings are completed, the surveyor will calculate the azimuth between the two survey reflectors for each set of readings. The azimuth readings will be compared with the headings taken on board the vessel from the gyro itself. If there has been little or no movement of the vessel, an average can be taken of the azimuths and for the gyro readings and compared. By calculating the standard deviation of the readings, the surveyor can determine the degree of movement during the recording process. If the deviation is greater than the stated accuracy of the gyro, the comparison readings should be based on simultaneous time.

Version	3.3	Rev	r000
Date	13-04-2017		

If physical adjustments are required, they should be made and the calibration process repeated. If the adjustment is determined to be minor and can be accounted for in the survey software, the correction value should be entered and then verified using the calibration process. This check of the calibration value can be an abbreviated version of the calibration process detailed above.

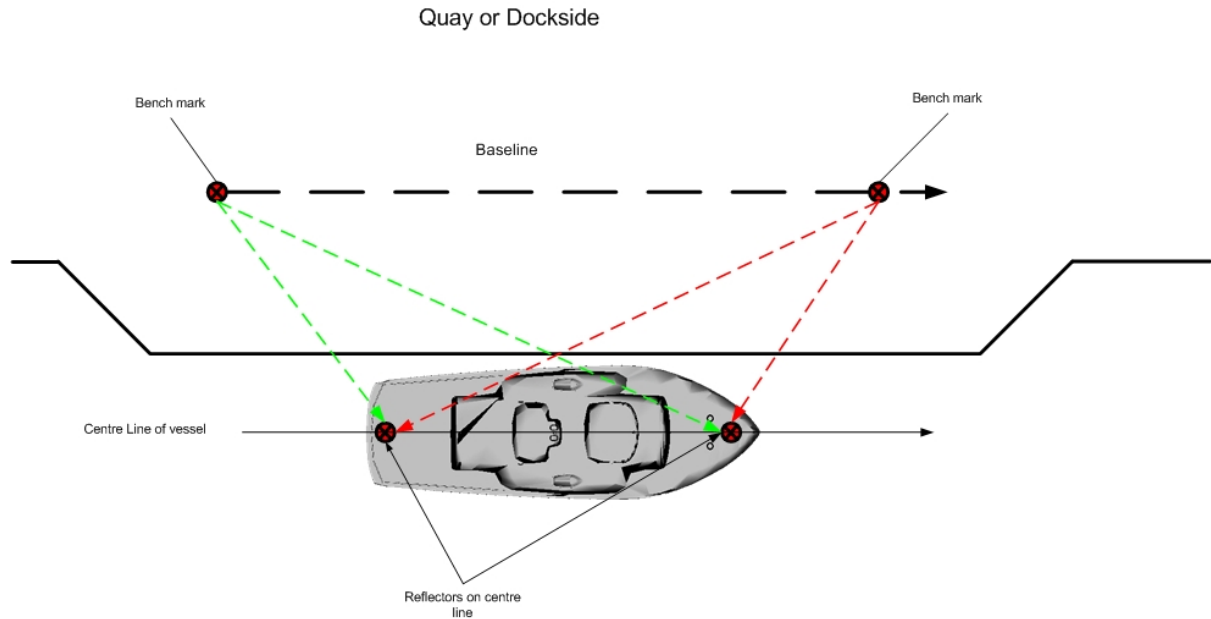

Figure 138: Gyrocompass Calibration method 1

- Quayside Benchmarks have known geodetic positions.
- Measure Range and Bearing to reflectors on vessel centre line.
- Using Range and Bearing to reflectors, determine geodetic position for reflectors.
- Calculate bearing from stern reflector to bow reflector will give the true heading of the vessel.
- True heading of vessel is then compared to gyrocompass reading taken at the same time as the Range and Bearing measurements.
- Benchmarks do not have to be on the quay, but should be in a position to give accurate Range and Bearing to the reflectors.

Version	3.3	Rev	r000
Date	13-04-2017		

8.3.1.2 Tape and Offset Method of Gyro Calibration

This method relies on measuring the offset distance from a baseline on the quay, with a known azimuth, to a baseline that is established on the vessel. There are greater areas for error when using this method, particularly in establishing a baseline with known azimuth.

A baseline is established on the quay as close as possible to the vessel's side. It is very important that the azimuth of this baseline be as accurately determined as possible. The baseline should be of a length that will exceed the baseline that is established on the vessel.

A baseline is established on the vessel that is parallel to the centre line of the vessel. It should not be assumed that the side of the vessel is parallel to the centre line. This baseline should be on the deck that faces the dock. The baseline on the vessel should be as long as possible, the longer the better.

With the vessel secured alongside the quay, the vessel baseline will be compared to the quayside baseline. Two points will be established on the quayside baseline that corresponds exactly to the fore and aft positions on the vessel baseline. That is: the points that are established on the quayside baseline should be normal to the points on the vessel baseline.

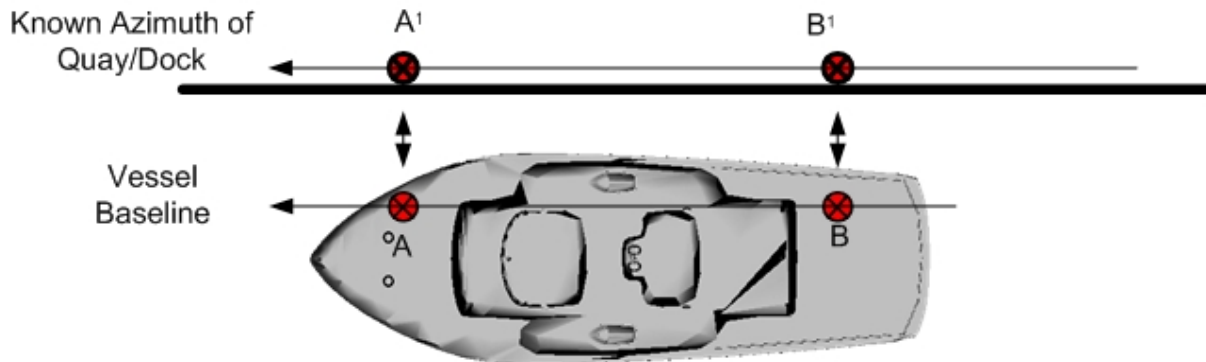

Figure 139: Gyro Calibration Method 2

The example, below, will illustrate the math involved.

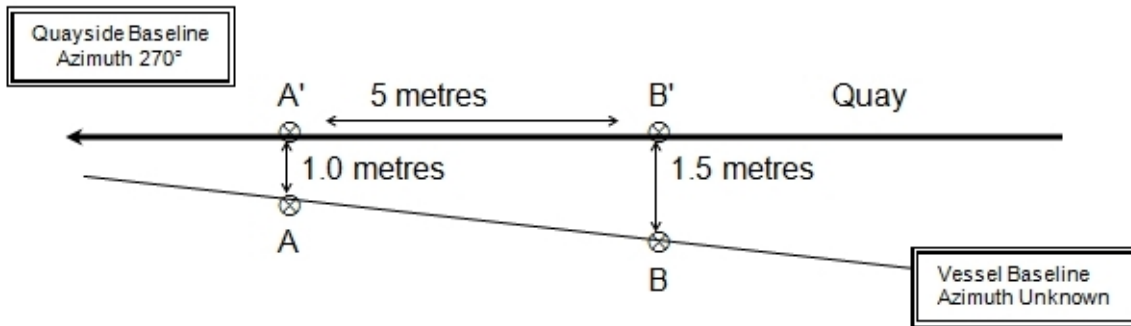

Figure 140: Gyro Calibration Method 2 example

A to A'	1.0 metres	B to B'	1.5 metres
Side a	5.0 metres	Side b	$1.5 - 1.0 = 0.5$ metres
Angle b'	$\text{Arctan } 0.5/5.0 = 5.7^\circ$		
Ship Azimuth = $270^\circ + 5.7^\circ = 275.7^\circ$			

Table 12: Gyro Calibration Method 2 computation

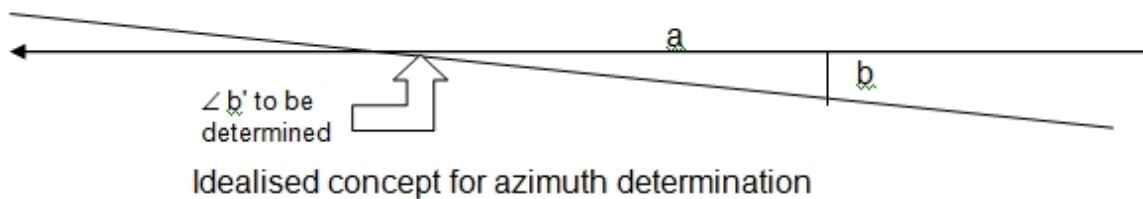

Figure 141: Idealised concept of Gyro Calibration Method 2

In this example, the vessel heading for this set of readings is 275.7° ; this would be compared to the gyro reading recorded at the same time the offsets were measured.

In the above example, if the bow was further out from the quay than the stern, the angle b' would be subtracted from the azimuth of the quay, i.e. $270^\circ - 5.7^\circ = 264.3^\circ$.

8.4 The Motion Sensor

The motion sensor is used to determine the attitude of the vessel in terms of pitch, roll and heave. Pitch is the movement of the bow going up and down. Roll is the movement of the port and starboard side going up and down. Heave is the vessel going up and down.

The sonar head is physically attached to the vessel; as the vessel moves, so does the sonar head. The motion sensor reports the movements of the vessel to the data collection software; the data collection software, using the offsets to the motion sensor and to the sonar head, computes the movement at the sonar head to correct the multibeam data for pitch, roll and heave.

One important aspect of the motion sensor is the sign convention used by the motion sensor as compared to the sign convention used in the collecting software. The surveyor must be aware of the convention that is used and what adjustments are necessary, if any, to ensure that the convention is consistent with the data collection computer.

There exist two major areas of thought as to where the motion sensor should be situated. One group believes that the motion sensor should go as close to the multibeam as possible, even if the multibeam is mounted on an over-the-side pole. The second group believes the motion sensor should be placed as close to the centre of rotation for the vessel as possible.

Placing the motion sensor on the hydrophone pole would seem to solve for all movement of the pole itself, but in fact the motion sensor, mounted in this fashion, can provide false attitude measurements. This is particularly true when there is significant roll; the motion sensor on the pole can interpret a portion of this roll as heave, which is not true. By placing the motion sensor as close to the centre of rotation (also called the centre of gravity) as possible, only the real heave of the vessel will be measured. All software will solve for the motion of the sonar head, based on the offsets that have been entered into the setup files for the vessel configuration; this is called a lever arm adjustment. The other consideration is that the motion data is usually applied to the GPS antenna. The GPS antenna is usually mounted high on the vessel, so any pitch or roll will induce a large amount of movement in the GPS antenna thus providing a false position due to the antenna movement. If the motion sensor is mounted on the hydrophone pole, it is reporting an exaggerated motion because it is far from the centre of motion of the vessel; this exaggerated motion then would be applied to the GPS antenna position and the vessel position computation would be in error.

The other consideration is that the alignment of the motion sensor must be on or parallel to the centre line of the vessel; it is essential to prevent ‘bleed-over’ of pitch and roll. If the motion sensor is not aligned with the centre line, when the vessel rolls some of the roll will be seen as pitch as the motion sensor’s accelerometers and gyros are not aligned with the axes of the vessel it is mounted on. It is more difficult to obtain this precise alignment if the motion sensor is placed on the pole.

Mount the motion sensor as close to the centre of rotation (or centre of gravity as possible) and perfectly aligned to the centre line of the vessel.

Version	3.3	Rev	r000
Date	13-04-2017		

The motion sensor should be mounted on as level a platform as possible. After mounting the motion sensor, the actual 'mounting angles' should be measured. Some motion sensors contain internal programs that can measure the mounting angles. Some data collection software packages also include the capability to measure mounting angles. The mounting angles are the measured degrees of the actual physical mounting of the motion sensor. This is to compensate for sloping or warped decks. Many decks have some slope to them and this should be accounted for to ensure that the pitch and roll values that the motion sensor derives is for vessel movement and not for its physical mounting on the deck. The mounting angles should be measured prior to any multibeam calibration and not changed after the calibration.

Prior to measuring the mounting angles, the vessel should be put in good trim by the engineer. On a small vessel it is important that the angles be measured without undue influence from people standing around. A false measurement can be induced by two people sitting on the gunwale having a conversation while the measuring process is being completed. It is usually a good idea to have all personnel leave a small vessel during the measuring process.

If the motion sensor mounting angles have been entered in the motion sensor or the data collection software, they can only be changed prior to the multibeam calibration (patch test); they are not to be changed after the patch test.

It is important to keep the motion sensor in mind when surveying. A motion sensor takes time to 'settle down' after a turn or a speed change and most of the settling down will depend on the heave bandwidth that is entered into the motion sensor. Some motion sensors can take in position, speed and heading data to assist them in the settling process. Depending on the degree of the turn or the amount of the speed change a practical period of 2 minutes should be allowed for the motion sensor to settle. It is prudent to plan the survey to allow for a long enough 'run-in' to the start of data collection to allow the motion sensor time to settle and the heave normalise. If this is not done, many times motion artefacts or erroneous depths will be seen at the beginning of line and the processed data will not be correct.

Monitor the motion sensor (all data collection software provides a time series window to monitor individual data) to ensure that it is operating properly.

8.5 Sound Velocity Probes

There are two basic types of sound velocity probes. One type measures the parameters of sound velocity in water; those being **C**onductivity (Salinity), **T**emperature, and **D**epth (Pressure), these are normally referred to as CTD probes. The other type of probe contains a small transducer and has a reflecting plate, at a known distance from the transducer that reflects the sound, the time is measured for this transmission and the sound velocity determined by that measurement; these are called Time of Flight probes. There is third type, known as the Expendable Bathythermograph (**XBT**) which is launched and as it passes through the water column sends back temperature readings (through two very thin wires); it is not recovered, it is expendable.

Version	3.3	Rev	r000
Date	13-04-2017		

The CTD and Time of Flight probes store the data internally. The data is downloaded to a computer after the probe is recovered.

8.5.1 CTD Probes

The CTD probe type of sound velocity probe has instruments to measure the conductivity of the water, water temperature, and a pressure sensor to measure depth. The CTD probe is a good choice if any of this information is also required; to obtain a velocity a formula must be used.

There are various formulae available that are based on the parameters that are recorded by the CTD. The UNESCO algorithm is considered a universal standard and was put forth by C-T. Chen and F.J. Millero in 1977. The Chen-Millero (and Li) equation is complex as is Del Grosso's (1974) and have been termed Refined. Simple formula, such as Mackenzie's (1981), also yields good results.

When using a CTD, it is very important that the probe be allowed to sit, fully submerged, in the water for a few minutes prior to deploying it; this is to allow the probe to reach equilibrium with the water temperature. It is also important that the tube, through which the water flows pass the sensors, is checked for obstructions or marine growth.

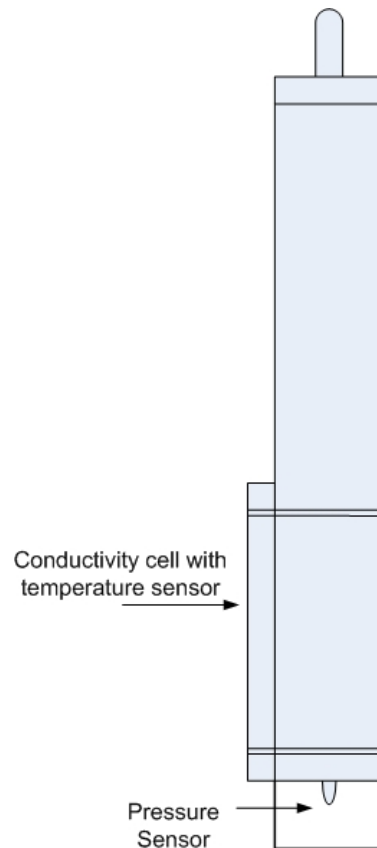

Figure 142: CTD Probe

Version	3.3	Rev	r000
Date	13-04-2017		

Part No. 96000005

8.5.2 Time of Flight Probe

The Time of Flight probe incorporates a transducer that transmits an acoustic pulse that reflects back from a plate that it is at a very precise distance from the transducer. The two-way travel time is measured, divided by 2, and the sound velocity determined. The Time of Flight probe is usually considered more accurate for multibeam survey work.

The sound velocity probe that is mounted close to the Sonic 2020 sonar head is a time of flight probe.

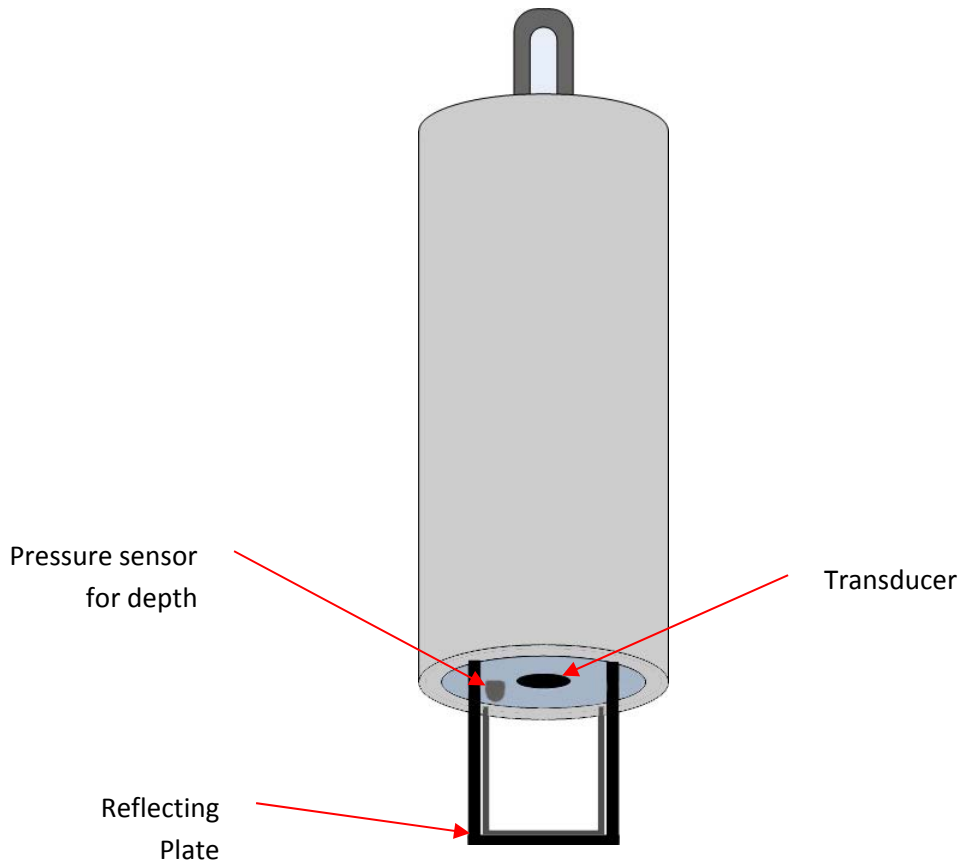

Figure 143: Time of Flight SV probe

8.5.3 XBT Probes

The XBT is a probe which free falls through the water column at a more or less constant speed (the probe is designed to fall at a known rate so that the depth can be inferred) and measures the temperature as it passes through the water column. Inside the probe is the thermograph, which is attached to a spool of very fine wire. Two very small wires transmit the temperature data from the probe back to a computer. The XBT is not recovered. XBT probes can be launched whilst underway

Version	3.3	Rev	r000
Date	13-04-2017		

and are used extensively by Navy and Defence forces for rapid determination of the sound velocity without stopping the vessel.

8.6 The sound velocity cast

There are no set rules for when to take a measurement of the water column sound velocity. Common sense is a good guideline. The conditions, detailed below, have a major influence as to when to take a sound velocity cast.

8.6.1 Time of Day

Throughout the day the upper level sound velocity characteristic will change mainly due to solar heating or cooling due to cloud cover or precipitation. Another main element of the time of day changes is tides.

When working in tidally influenced areas, the sound velocity can change drastically due to a salt wedge that moves in and out with the tide. The surveyor must be aware of the relationship of the time of the tide to the salt wedge.

8.6.2 Fresh water influx

Any river, stream or runoff will drastically change the sound velocity through the introduction of freshwater and also through a temperature difference.

8.6.3 Water Depth

The sound velocity cast should always be made in the deepest part of the survey area. The sound velocity profile cannot be extrapolated to deeper depths as there are too many possible variables.

8.6.4 Distance

If the survey area is large, then it is quite possible that there will be differences across the range of the survey area even in open water.

8.6.5 Deploying and recovering the Sound Velocity Probe

The guide lines for deploying and recovering the sound velocity probe are based on common sense, but are sometimes ignored during the actual operation. The guidelines, below, are for a hand cast in shallow water. The softline, used for the cast, should be marked to provide an indication of the amount of line out.

8.6.5.1 Shallow water sound velocity cast / deployment by hand

1. Plan where the cast is to be made.
 - a. In a small area, deploy in the deepest part of the survey area.
 - b. Always do a cast prior to starting the survey.
2. Liaise with the captain or officer of the watch with the plan position and time of deployment and time required for the cast.
3. Prepare the probe for casting (some probes may need to be programmed prior to each launch).
4. Secure the probe to the downline with a bowline knot or shackle.

5. **Secure the bitter end of the downline to the vessel.**
6. Request permission, from the bridge or helm, to deploy and await their OK to launch.
 - a. Bridge or helm to ensure that the vessel is out of traffic.
 - b. Bridge or helm to assess wind and sea conditions and advise as to which side of vessel the deployment should be made.
7. Put the probe in the water until it is totally covered and let it remain there for a period of time to acclimate to the sea temperature. This is very important with a CTD type of probe, but of less concern for a time-of-flight probe.
8. Verify the water depth.
9. Lower the probe at a constant rate; only the downcast should be used.
10. Try not to allow the probe to touch the bottom.
11. Recover the probe rapidly.
12. As soon as the probe is on deck, notify the bridge or helm that they are free to manoeuvre, but remain in the area.
13. Rinse the probe with fresh water and dry thoroughly.
14. Download the cast and verify that it looks good.
15. Load the cast into the data collection software.

8.6.5.2 Deep Water Cast / Deployment by mechanical means

A cast in deeper water requires more preparation and planning. A deep water cast can be considered to be any cast that is deployed via an 'A' Frame, winch, or other mechanical means. Even a shallow water cast can fall under this definition when mechanical means are used.

One of the main concerns, in a deep water cast, is that the probe will not go straight down due to the current flow or vessel drift due to wind and/or currents. This being the case, weights must be used to ensure the cable (and probe) go as straight down as possible.

Unless the sound velocity probe is designed to have additional weight attached to it, no weights should be attached to the sound velocity probe. The weights, which enable deployment as straight as possible, are attached to the end of the cable. The probe should be attached to the cable approximately 3 – 5 metres above the weights; if the weights hit the bottom this should provide enough scope for the probe to land clear of the weights.

Version	3.3	Rev	r000
Date	13-04-2017		

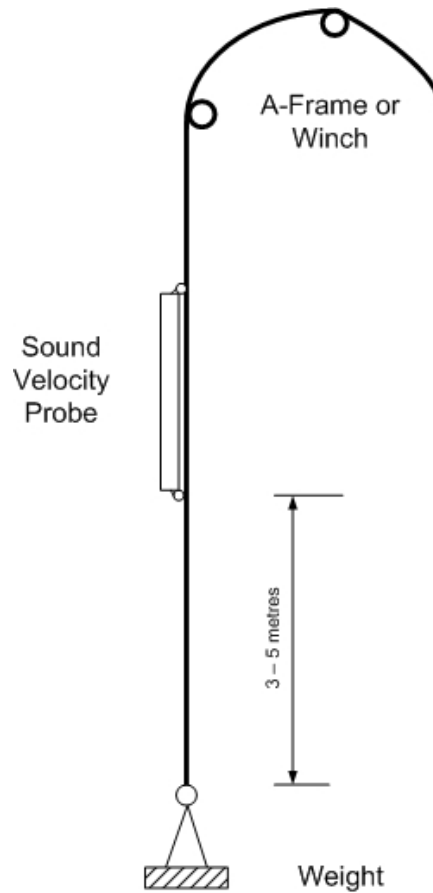

Figure 144: Deploying a sound velocity probe via a winch or A - Frame

The other major consideration, when deploying a probe in deeper water, is that the vessel must be stationary longer and will drift. If there is a large variation in depths, the depth where the probe went in, may not be the same depth when the probe reaches the bottom. It is essential that enough cable be deployed to ensure a full profile to the sea floor.

Version	3.3	Rev	r000
Date	13-04-2017		

APPENDIX III: Multibeam Surveying

9 APPENDIX III: Multibeam Surveying

9.1 Introduction

Multibeam surveying affords the surveyor with many advantages, but it also requires more thought behind the survey itself.

9.2 Survey Design

Multibeam surveying survey planning is very different than single beam survey planning. The main considerations are line spacing and line direction. In single beam surveying, lines are normally spaced based on the scale of the desired chart. The line direction is normally at the discretion of the surveyor. In multibeam surveying, the surveyor has to plan the survey carefully, with thought to overlap between adjacent lines and the direction that those lines are run.

9.2.1 Line Spacing

The entire concept of multibeam surveying is based on the swath coverage that defines the multibeam system. The survey lines should be designed so that there is 100% overlap in coverage between adjacent lines. As swath width is a function of water depth, it follows that the spacing between lines may not be constant. Looking at a chart of the survey area, the surveyor should be able to determine the swath width that will be obtained and can design the line spacing accordingly.

A large overlap in swath coverage is required due to various factors. One prime factor is roll. As the vessel rolls the swath coverage will vary in relation to this roll. If the vessel rolls to port (port-side down), the swath coverage on the port side will be lessened, whereas the swath coverage on the starboard side will increase. If there is not sufficient overlap in swath coverage there could be gaps in coverage, between adjacent lines, due to the roll.

If the helmsman has problems keeping the vessel on the designated line, this could cause gaps if the vessel goes off line to opposite directions on adjacent lines.

Unexpected shallows will reduce the swath coverage. If the lines are designed with very little overlap, a shallow area on the lines will see reduced swath coverage and the possibility of gaps between the lines.

9.2.2 Line Direction

In single beam surveying, the usual practice is to survey normal to the contours. The concept is to cut the contours at 90° to obtain the best definition of the slope. Multibeam survey is exactly opposite of this; in multibeam survey the lines are planned to survey parallel to the contours. Multibeam surveying can be likened to side scan surveying; the best definition is obtained when the

Version	3.3	Rev	r000
Date	13-04-2017		

slope is within the port or starboard swath coverage. There will be poor definition of the slope covered by the nadir beams, as they act similar to a single beam echosounder.

In setting up the survey lines, if the lines were to run up and down slope, the spacing would have to vary between the start and the end of the lines, as the swath coverage would vary due to the change in water depth. The lines would not be parallel. By surveying along the contours, the depths will remain more or less constant so that the spacing does not have to change from beginning to end. However, the spacing between adjoining lines may vary due to increased or decreased depth.

9.2.3 Line Run-in

As was previously noted, it is good survey practice to allow the motion sensor and gyro time to settle after making a turn. With this in mind, the surveyor should set up the survey lines so that an adequate lead in, before the start of data recording, is allowed.

Extra lead in time allows the helmsman the opportunity to get on to the line and make any adjustments that are necessary to counteract wind or current conditions. It is much better for the vessel to be a little off of the planned survey line, but heading in a straight direction, rather than ‘fish-tailing’ back on forth across the line, trying to maintain zero offline.

Surveying into a beach may only allow very limited run-in, if the lines are also to be surveyed out from the beach. In this case it may be better to design the lines so that they run parallel to the beach. Of course, if it shallows greatly towards the beach, the lines should be run parallel to this slope anyway as detailed above.

9.3 Record Keeping

It is essential that detailed records be kept of all aspects of the multibeam survey. The logging of all details of the survey will greatly assist those in charge of processing the data. Maintaining a vessel log, that reflects offsets, draft measurements, sound velocity profiles and etc.; will give the surveyor a reference that can be easily accessed. The more information that is logged, the easier it will be during processing and it will also provide the surveyor with a means to assess survey technique with a view to improving the efficiency of the survey.

9.3.1 Vessel Record

A hardbound ledger book should be kept for the vessel record. The vessel record should include, but is not limited to:

- Diagram of the vessel with measurements
- All offsets
- Daily draft measurements
- Diary of sound velocity profiles
- Surveyors / Operators
- Equipment list
- Equipment interface information
- Diary reflecting dates of individual surveys

Version	3.3	Rev	r000
Date	13-04-2017		

The vessel record is meant to be a quick reference for general information that is required for multibeam surveying. Some of the information does not change from survey to survey and should go either in the front of the book or the back of the book. A section of pages can then be devoted to the information that does change from survey to survey or day to day.

As an example:

- Page 1 – Plan of the vessel with all vessel measurements
- Page 2/5 – Plan of the vessel with all offsets
- Page 6/9 – Equipment list and interfacing information
- Pages 10/20 – Dates of individual surveys with listing of surveyors responsible for those surveys
- Pages 21/40 – Diary of draft measurements
- Pages 41/60 –Diary of sound velocity measurements

As can be seen, this is a general reference which can provide dates and general details.

When naming surveys and sound velocities, a certain degree of logic in their naming will greatly assist deciphering an individual event out of many events. In the case of sound velocity profiles, it is common to name the profiles for the date that they were taken. A sound velocity profile taken on 04 July 2015 would be referred to as 20150704. If more than one profile is taken during the day, then a letter suffix can be added: 20150704a, to separate the profiles, or a time of cast can be added to the file name. Keep in mind that personnel, who were not on board during the data collection, may need to reference the information; keeping it logical and chronological will help.

Ensure that many blank pages are kept for the various categories. When a book is filled, plainly mark on the cover the inclusive dates that the vessel log covers. If possible, also mark this information along the spine of the vessel log. These logs should be kept in a safe and dry place on the vessel.

9.3.2 Daily Survey Log

The Daily Survey Log is where all the details of the survey are recorded: start/stop time of the lines, line names, and line direction, speed of survey, and comments pertaining to that survey line. A copy of the appropriate survey log should accompany all multibeam data along its path during processing.

Daily Survey Logs are of two types: rough and smooth. The smooth log is a sheet that is arranged in rows and columns, where the appropriate survey information is entered, much like a spread sheet. It can be a single sheet that is printed out on board, or it can be professionally produced pad of sheets. The rough log is similar to the vessel log; it is normally a ledger book; the start/stop times, line name, line direction and comments are entered line by line, usually on the right hand page as they occur. The left hand page then is left for details of draft, sound velocity profile data, tides or any other information that is pertinent to the lines that are detailed on the right hand page.

Version	3.3	Rev	r000
Date	13-04-2017		

A copy of the survey log is sent along with the multibeam data to processing and a copy is kept on board the vessel.

An example of the information on a smooth log:

- Sensor offsets
- Calibration offsets
- Date
- Survey name, area and surveyors
- Name of sound velocity file
- Name of tide file
- Vessel name
- Start/Stop time of survey line
- Line name
- Direction
- Comments

Due to the nature of a single sheet type log, the information should be entered on each individual sheet, even though many items do not change from one day to the next.

With the log book style of daily log the items that do not change can be listed on one page, so that everything following that page will be under those parameters (offsets, vessel name etc.). The right hand page will include the start/stop times, line name, direction and comments. The left hand page, as noted above, is for additional information. A further advantage to using a log book is the space available to sketch diagrams of the survey or other visual aids that might make the survey easier to understand.

The surveyor uses a log book to record the data as it occurs. A daily survey log sheet can be created in any word processor or spread sheet program. At a convenient time the surveyor can call a sheet up, within the appropriate program, enter the data and print it out. This has many advantages, the most obvious is that the daily log sheet is typed in and printed out making it very legible to read; it can be stored down to memory, making a permanent record.

Although maintaining a good detailed log of daily survey events may be difficult to get used to, after a short time the advantages will become obvious.

Version	3.3	Rev	r000
Date	13-04-2017		

390110
80 Meter Line Spacing

E 365845
N 4162200

Lines Numbered from N to S.

200. PUP

CM 123 3645845 E
4162187 N

Spring to Line 12 by Rock and a run
with tide.

V/L to Por O/L (40 meters South)

Going to Line 23 just South of
Line 11

1012 Line 1 → 270° 9.45s drop
1015 7.5Kts
1019 EOL 1
1023 Line 1A → 090° 7.3Kts for E.
1031 EOL 1A Run Ck Cr
1034 Line 2 → 270°
1042 EOL 2
1044 Line 3 → 090° 7.2Kts
1052 EOL 3
1055 Line 4 → 270°
1102 EOL 4
1105 Line 5 → 090°
1105 @ SOL No jump yet unste.
due to jump 1st 5 minutes
Line to be to claw
1113 EOL 5
1115 Line 6 → 270° 7.5Kts
1122 EOL 6
1127 Line 7 → 090° 7.3Kts
1135 EOL Rock on STD 5.1N
1137 Line 11 → 270° 7.4Kts
1145 EOL 11
1148 Line 10 → 090°
1156 EOL 10
1158 Line 9 → 270° 7.6Kts
1205 EOL 9
1208 Line 7 → 090°
1215 EOL 7
1219 Line 8 → 270°
1226 EOL 8

END OF E/W Lines

Figure 145: Rough log, kept during survey operations...does not need to be neat, but must contain all pertinent information

Version	3.3	Rev	r000
Date	13-04-2017		

2002 Sydney Harbour Survey										
DATE: 13 May 2002 (UTC)			SURVEY NAME: Area B/ Area A				PAGE/PAGES 1/1			
Vessel: 440			All Times in UTC (UTC = LOCAL - 10)							
OFFSET INFORMATION (metres)				NB Draft change				SV Profiles		20020512_2300UTC
										20020513_2240UTC
	X	Y	Z	Pitch	Roll	Yaw	Latency			
Multibeam	0.0	4.21	-1.00	0.673°	0.692°	3.43°				
Motion Sens	0.0	0.0	0.295							
DGPS	-1.40	-3.40	3.38				0 (Used PPS)	Tide File 200205_11-15UTC.tid.txt		
GEODESY		Datum: WGS 84		Projection: UTM Zone 56S (CM 153° E)						
Start	Stop	Line Name			Direction	Speed	Comments			
0021	0033	0042 Area B (200)			038°	5.1 kts				
0038	0052	0043 Area B (190)			218°	4.4 kts				
0058	0107	0044 Area B (180)			038°	5.4 kts				
0111	0118	0045 Area B (170)			218°	4.2 kts	Stop line, computer not responding well.			
0126	0137	0046 Area B (170)			218°	4.0 kts	Completion of above line after circle.			
0140	0150	0047 Area B (160)			038°	5.2 kts				
0157	0211	0048 Area B (150)			218°	4.0 kts				
0225	0225	0049 Area B (Infill)					Infill Lines various headings and speeds			
0228	0229	0050 Area B (Infill)								
0232	0232	0051 Area B (Infill)								
0234	0235	0052 Area B (Infill)								
0235	0237	0053 Area B (Infill)								
0237	0238	0054 Area B (Infill)								
0242	0243	0055 Area B (Infill)								
0246	0246	0056 Area B (Infill)								
0248	0249	0057 Area B (Infill)								
STOP AREA B SURVEY										
START AREA A SURVEY										
2240		SV Profile 20020513_2240UTC					33° 50' 9S, 151° 12' 0E, 333470E, 6253200N			
2315	2325	0001 Western Centreline			297°	5.2 kts	@2321 noise on starboard side due to other vessel			
2334	2347	0002 Western Centreline (25)			117°	4.4 kts	@2340 Mouse button stuck, range ran too shallow			
2351	2358	0003 Western Centreline (-25)			297°	4.4 kts	Stop line - Lost differentials			
LAST ENTRY										
Surveyor: Charles W. Brennan				Signed: 						

Figure 146: Smooth log; information copied from real-time survey log

APPENDIX IV: Offset Measurements

10 APPENDIX IV: Offset Measurements

10.1 Lever Arm Measurement – Offsets

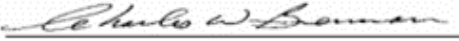
Each component or sensor that produces information, unique to its position, will have a point that is considered the reference point of that sensor. The Sonic 2020, the motion sensor, and the GPS antenna will have a documented point from which to measure. The gyrocompass' data is not dependent on its position on the vessel so, therefore, does not require an offset measurement.

10.2 Vessel Reference System

When all equipment (Sonic 2020 sonar head, motion sensor, gyrocompass and GPS) have been permanently mounted, the physical offsets to a central reference point (CRP) must be measured. The central reference point (CRP) or vessel reference point (VRP) is that point that the surveyor chooses to be the origin for the X and Y grid that will define the horizontal relationship between all of the sensors. The vertical or Z reference can be the water line or other logical vertical reference. Generally, the CRP corresponds to the centre of gravity or rotation of the vessel. All of the sensors must have their physical relationship to each other measured and entered into the data collection software or the processing software.

All offsets, between sensors, are defined by an X, Y and Z offset from a reference (CRP or VRP) point. The X axis runs athwartship, i.e. from the port side to the starboard side. The Y axis runs alongship from the bow to the stern. The Z axis runs perpendicular through the reference. The origin can be any point; the origin will remain the same for all sensors. Some surveyors take the GPS antenna as the origin for all measurements, others take the sonar head itself, while others might take the motion sensor (especially if it on the centre of rotation for the vessel). The sign convention is standard for a Cartesian plane, translated to a vessel: starboard of the reference point is positive, forward of the reference point is positive. The sign for Z may differ, depending on the data collection or processing software.

Version	3.3	REV	r000
Date	13-04-2017		

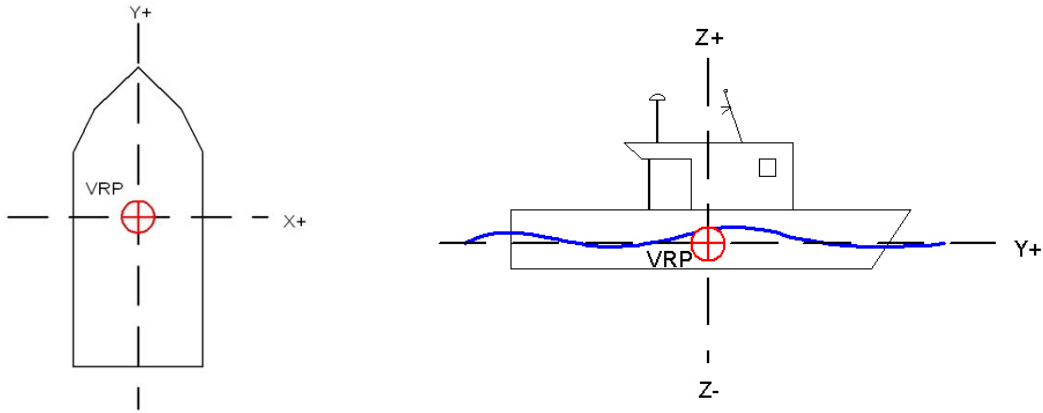

Figure 147: Vessel Horizontal and Vertical reference system

10.3 Measuring Offsets

The accurate measurement of offsets is vital to the accuracy of the survey data. If possible, the vessel will be put on a hard stand so that it can be very accurately measured using standard land survey equipment, such as a total station. However, this may not be possible and the offsets will have to be measured using a tape and plumb-bob, which is detailed below.

10.3.1 Sonic 2020 Acoustic Centre

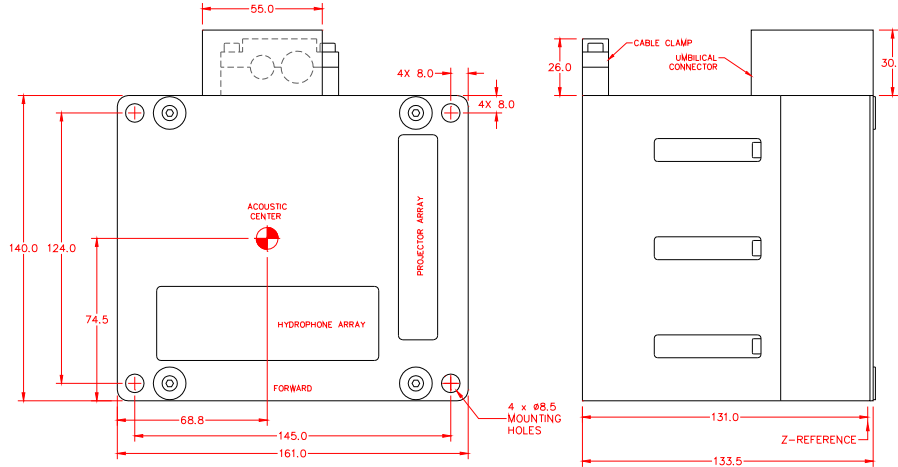

Figure 148: Sonic 2020 Acoustic Centre

10.3.2 Horizontal Measurement

All measurements should be made with a metal tape measure. A cloth tape can stretch, it can also be knotted or kinked, unknown to the persons making the measurements. At a minimum, two people should be assigned to take the measurements; three people will work better with the third person writing down the measurements. One person will be the holder and the other will be the reader. Starting at the reference point or the sensor, the distance will be measured. When either the reference point or the sensor is reached, the two people will reverse roles: the holder is now the

Version	3.3	Rev	r000
Date	13-04-2017		
Part No. 96000005			

reader and the reader is the holder, the transverse is made back to the point of beginning, but not using the same path. If reference marks were made on the first leg, they should not be used on the second leg back. If the measurement from the sensor to the reference point, in one direction, agrees with the measurement in the opposite direction, made by a different reader and holder, then the offset is good. If there is a small disagreement in measurements, the two measurements can be averaged. If there is a large disagreement then the process should be repeated. What is a small disagreement? A few centimetres can be expected.

10.3.3 Vertical Measurement

To measure elevations or the Z offset, the use of a plumb bob is required. This can be something as simple as a spanner tied to a length of line and lowered from one deck to the next. The plumb bob will also allow for accurate measurements in the X and Y direction when transposing them from one deck to the other.

The plumb bob works, of course, by gravity so generally points to the centre of the earth. This being the case, if the vessel is not in good trim, i.e. has a list, the resting position of the plumb bob may not be at the true vertical point under the place from which it is being held. This is very critical when transposing X and Y measurements from one deck to another.

The draft of a vessel will not be constant. Prior to going out on a survey, the fuel and water may be filled up, causing the vessel to settle lower in the water. Possibly less people are on board causing the vessel to rise higher in the water. The main concept here is that the draft of the sonar head changes. All X and Y offsets remain the same as long as the sensors are not moved, but the Z offset changes constantly depending on the draft of the vessel.

If possible, the pole should be marked to show the depth of the head. Measuring up from the sonar head's acoustical reference, rings can be painted on the pole in 10 cm (or other) increments, with 2 cm hatching between rings. The surveyor may have to observe the pole over the course of a few minutes to determine where the water line is and would then estimate the depth by interpolating between the 10 cm depth rings.

Another method would be for the surveyor to initially measure from the sonar head's acoustical reference to the top of the hydrophone pole. This is the total pole measurement. At the start of a survey day, the surveyor will go to the pole and measure from the top of the pole to the water line (using the tape measure and plumb bob or similar weight), this is called the dry measurement. Taking the dry measurement from the total pole measurement yields the wet measurement, which is the draft of the sonar head. Due to wave motion, the surveyor may have to take a series of measurements to ensure an accurate reading.

When the draft or Z of the sonar head is determined the Z for the GPS antenna and the motion sensor can be adjusted accordingly, if the Z reference is the water line. In most data collection software a Z shift, in relation to the water surface, can be entered in for the CRP, which will do the vertical adjustment for all offsets

It is very important that when measuring the draft on small vessels that the person taking the measurement does not unduly cause the vessel to list towards that side. Having someone counter balance the weight of the person taking the measurement is a good idea. This is also true of any temporary list the vessel is experiencing. On small survey vessels, a person leaning over the side, to

Version	3.3	Rev	r000
Date	13-04-2017		

take the draft measurement, can induce upwards, or exceeding a 10cm error in depth readings during survey operation.

On some vessels it is advisable to take draft readings during the survey or immediately after completion of the survey, as the draft will change that much.

All offset information should be recorded in the daily survey log and the vessel's permanent survey record.

Version	3.3	Rev	r000
Date	13-04-2017		

Part No. 96000005

APPENDIX V: The Patch Test

11 APPENDIX V: The Patch Test

11.1 Introduction

The alignment of the Sonic 2020 sonar head to the motion sensor and gyro is critical to the accuracy of the determined depths. It is not possible to install the sonar head in exact alignment with the motion sensor and gyro to the accuracy required ($x.xx^\circ$). If GPS time synchronization is not used, the latency of the position, as reported by the GPS, must also be measured during the calibration. This being the case a multibeam calibration must be performed to measure the angular misalignment between the Sonic 2020 and the motion sensor and gyro and, if necessary, the position latency; this is called the Patch Test.

The patch test is performed with each new installation or whenever a sensor is moved. In the case of an over-the-side mount, a large number of calibration computations need to be performed to determine how well the pole goes back into the same position each time it is deployed. With more permanent mounting arrangements, a minimum of 5 separate patch tests should be conducted in order to derive a standard deviation that would indicate the accuracy of the derived values.

The patch test involves collecting data over certain types of bottom terrain and processing the data through a set of patch test tools. There are two primary methods of processing the data that are currently used: an interactive graphical approach and an automatic, iterative surface match. Each of these techniques has strengths and weaknesses and the preferred approach is dependent on the types of terrain features available to the surveyor. All modern multibeam data collection software packages contain a patch test routine. Please read the software manual for explicit information regarding the requirements for that software's patch test. The below criteria is, in general, the norm for a patch test.

11.2 Orientation of the Sonic 2020 Sonar Head

The orientation of the sonar head must be known in order to convert the measured slant ranges to depths and to determine the position of each of the determined depths.

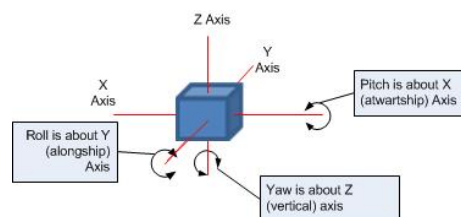

Figure 149: Sonic 2020 axes of rotation

Any error in the measured roll of the Sonic 2020 sonar head can cause substantial errors in the conversion from slant range to depth. A roll error of 1° on a 50 m slant range will cause a 0.6 m error in the resulting depth. Any error in the measured pitch of the Sonic 2020 head will

primarily have a detrimental effect on the accuracy of the positions that are determined for each slant range/depth.

A pitch error of 1° will cause an along-track error in the position of 0.4 meter when the sonar head is 25 meters above the seabed.

Version	3.3	Rev	r000
Date	13-04-2017		

11.3 Patch Test Criteria

The patch test requires collecting sounding data over two distinct types of sea floor topography; a flat bottom is used for the roll computation whereas a steep slope or feature is used for the latency, pitch, and yaw data collection.

Care must be taken that the sonar head covers the same area on both data collection runs, this may not be the same as vessel position, especially with an over-the-side mount or if the sonar head rotated. Only the latency data collection requires a different speed from normal survey speed.

The data collection for Latency, Pitch and Yaw should be done in as deep water as possible. This is particularly true for the pitch computation due to the fact that in shallow water the angle of pitch may not be easily determined due to a lack of resolution.

11.3.1 Latency Test

The vast majority of installations will incorporate GPS time synchronisation and, as such, no latency is expected in the GPS position. However, it is necessary to complete at least one or two latency tests to prove that the latency, for all practical purposes, is zero. Most patch test programs will not yield zero latency, but the derived value would be so small so as to constitute a practical zero.

For the latency test, data is collected on a pre-defined line up a steep slope or over a well-defined object (such as a rock or small wreck). The line is surveyed at survey speed up the slope, and then surveyed again, in the same direction, but at a speed that should be half of the survey speed. If the vessel cannot make way at half survey speed then the fast run will need to be taken at a higher speed than normal survey speed and this can influence the latency test due to squat or settlement. The main consideration is that one line should be twice the speed of the other.

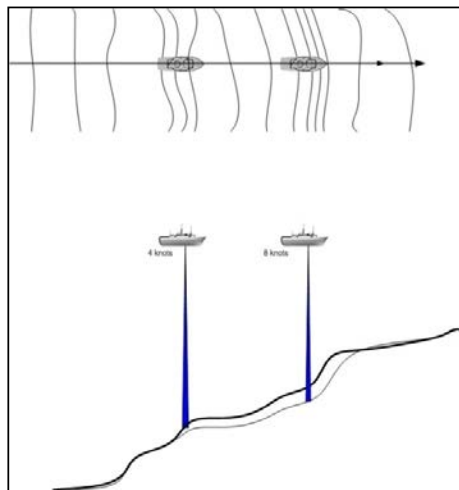

Figure 150: Latency Data collection

Version	3.3	Rev	r000
Date	13-04-2017		

11.3.2 Roll Test

The data collection for roll has to be over a flat sea floor. One line is surveyed twice, in reciprocal directions and at survey speed.

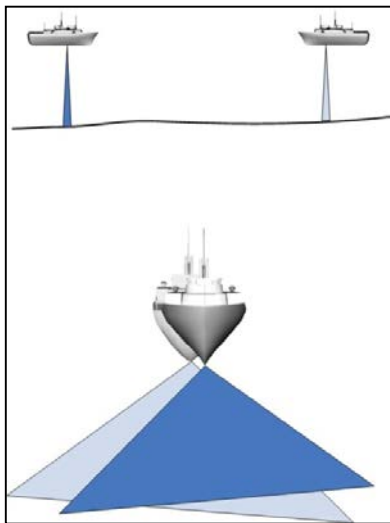

Figure 151: Roll data collection

When the data, from the two data collections, are looked at in profile, there will be two seafloors sloped in opposite directions. Most patch test programs will go through a series of iterations to determine when the difference between the two surfaces is the smallest, and this is the roll offset.



Figure 152: Roll data collections

Roll is perhaps the most critical value in the patch test routine as an error in roll will result in an error in sounding depths.

However, the computation to determine the roll misalignment is usually the easiest and most consistent.

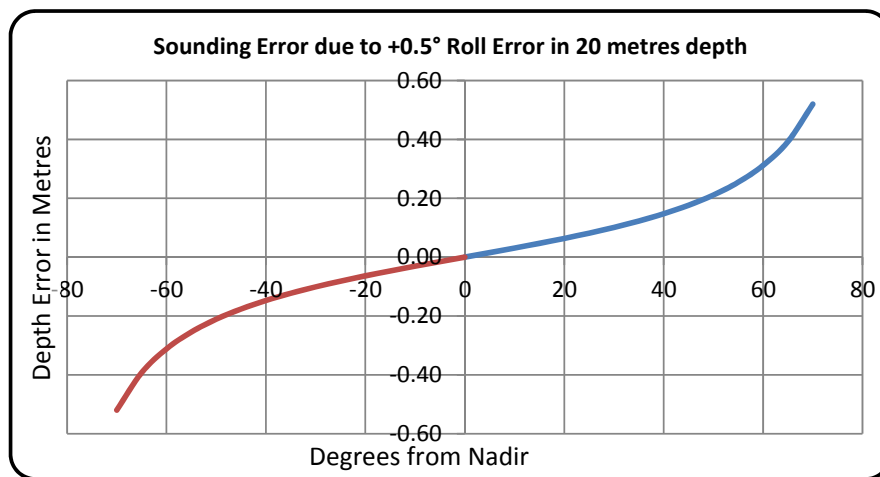

Graph 1: Depth errors due to incorrect roll alignment

Version	3.3	Rev	r000
Date	13-04-2017		

11.3.3 Pitch Test

The pitch data collection is over the same type of sea floor as the latency data collection, i.e. steep slope or feature on the sea floor. One line is surveyed, twice, in reciprocal directions at survey speed. It is very critical that the sonar head passes over the same exact part of the slope on each run.

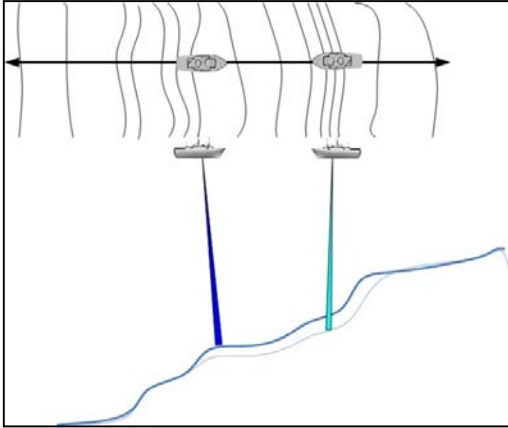

A profile of the data will show two different slopes, which represent the reciprocal data collections. The patch test software goes through a series of iterations of pitch angle corrections until the difference between the two surfaces reaches a null. Whatever the angle of correction, which results in the minima or null, that angle will be reported as the pitch misalignment.

Figure 153: Pitch data collections

A pitch error will result in an along-track position error, which increases greatly with depth

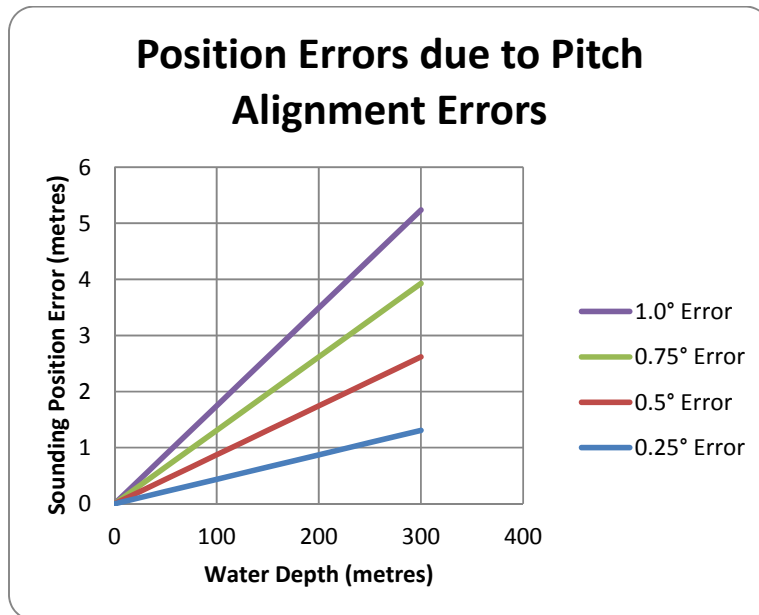

Graph 2: Position errors as a result of pitch misalignment; error can be either negative or positive

11.3.4 Yaw Test

The yaw data collection and subsequent solving for the yaw offset is usually the most difficult of the 4 tests that comprise a patch test. This is especially true if a slope is used for the yaw computation; a feature generally works much better. The reason for this is that the area that is used for the computation is not directly under the vessel, but in the outer beams and the slope may not be perfectly perpendicular in relation to the course of the vessel.

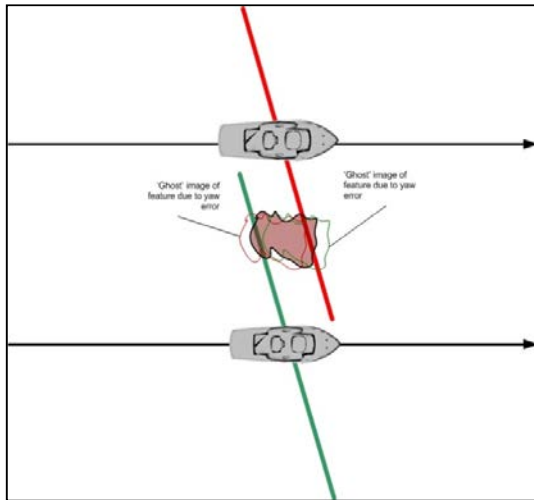

For the Yaw data collection two parallel lines are used, with the vessel surveying in the same direction on those lines. The lines are to be on either side of a sea floor feature or over a slope. The lines should be approximately 2 – 3 times water depth in separation. A yaw error will result in a depth position error, which increase with the distance away from nadir.

Figure 154: Yaw data collection

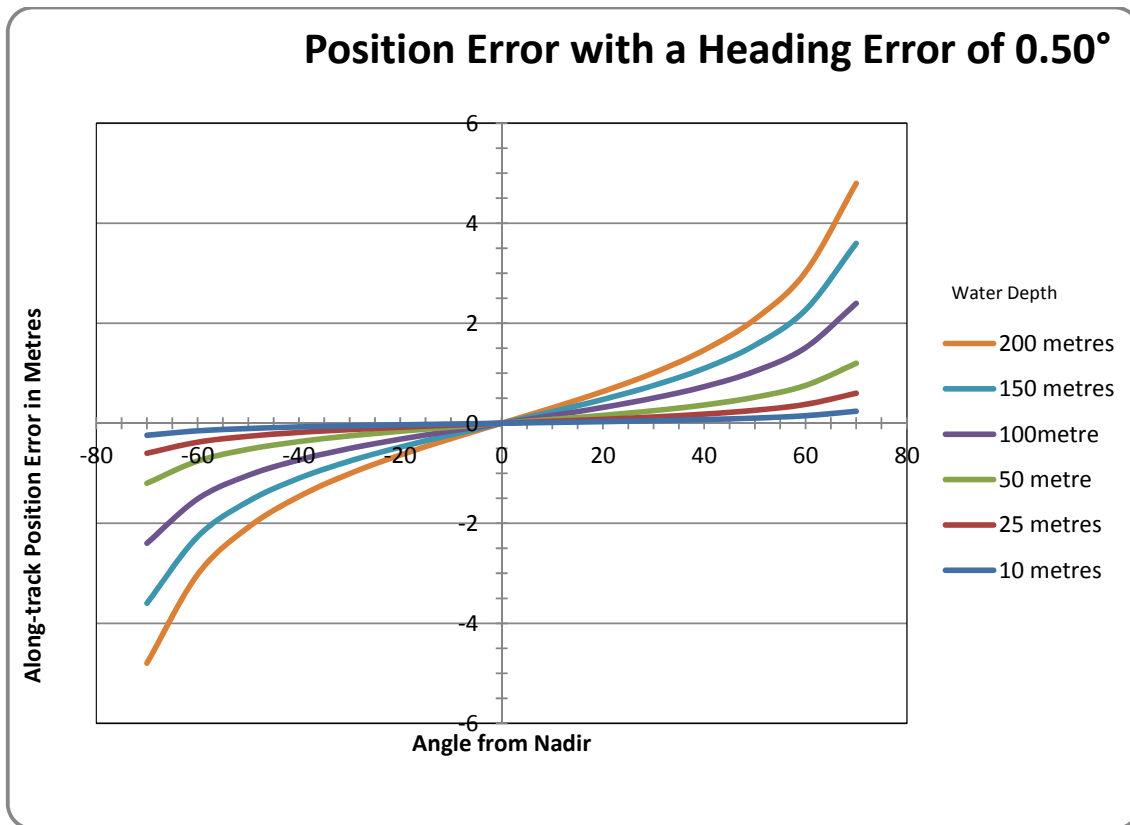

Graph 3: Along track position error caused by 0.5° error in yaw patch test

Version	3.3	Rev	r000
Date	13-04-2017		

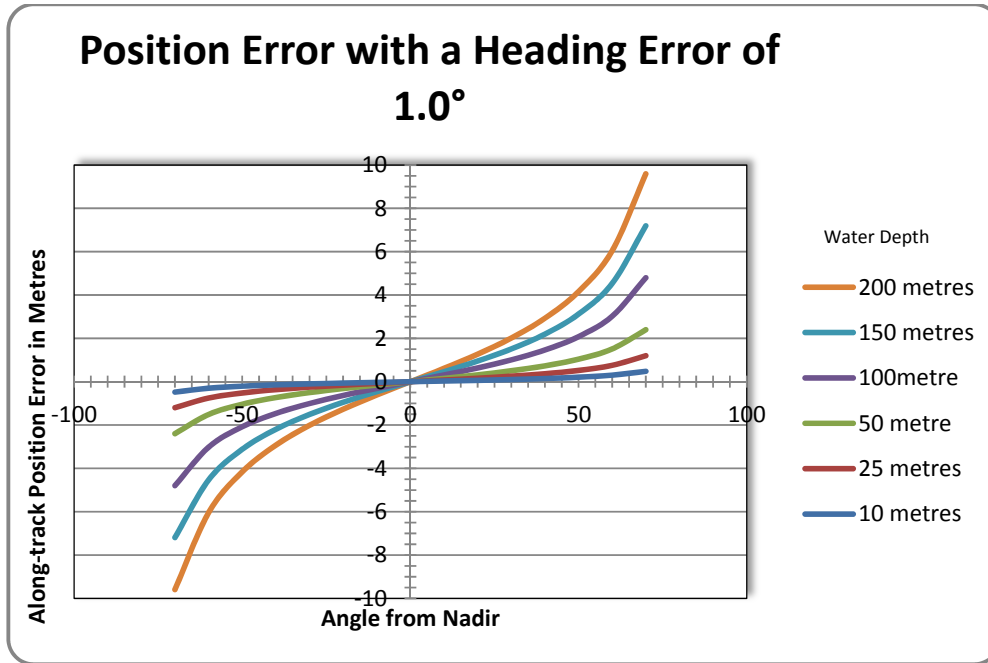

Graph 4: Along-track position error caused by 1.0° error in yaw patch test error

11.4 Solving for the Patch Test

Depending on the data collection software that is employed and how it solves for the patch test, there will be a distinct order that the tests will be solved for, but this does not influence the data collection for the patch test. In general, latency will be solved before pitch; roll will be solved for before yaw. It is not uncommon that a larger than expected error in one of the tests will make it necessary to go back and resolve for all previous values. This can be the case with a large yaw offset, as this will influence to a greater degree the accuracy of the latency and pitch computations if done using a slope.

The resultant patch test values are corrections that are entered in the data collection software and not in the Sonic 2020 software, as the values are used for process data.

11.5 History

Since the advent of commercial multibeam echosounders there has been the need to measure the angular offsets between the multibeam sonar head and the auxiliary sensors that provide attitude and heading information. Another measurement is made to determine the latency, in the GPS receiver. Multibeam data is collected that is used to determine (1) latency, (2) roll offset, (3) pitch offset and (4) heading or yaw offset

What has been developed is called the Patch Test; this is the multibeam calibration. During the development of the data collection criteria, for the Patch Test, there has only been a basic description for the manner of the data collection; providing little, if any, directions that would help create a high degree of confidence in the results of the various tests. This section will

Version	3.3	Rev	r000
Date	13-04-2017		
Part No. 96000005			

address those very directions that will help create a highly accurate and statistically viable result from the Patch Test.

11.6 Basic data collection criteria

Patch test data collection does not have to be in any set order, but the order that the values are computed, in the data collection or processing software, will be in a distinct order. Normally, Latency is the first value that is computed, followed by Roll, Pitch and Yaw (or heading). The solving order is important, as will be seen below.

11.7 Patch Test data collection error areas

There are many common errors, or mistakes, made during the patch test data collection.

11.7.1 Positioning

The accuracy of the positioning system is a common area where errors arise. DGPS has, at best, a variability of ± 0.50 metres, whereas RTK variability is ± 0.05 metres.

A recent article, in *Hydro International* ('Stop Using DGPS'; Hydro International; Volume 16, Issue 7; Oct 2012) documents this issue very well:

The article fully details the errors that can occur by using DGPS, instead of highly accurate positioning for the Patch Test data collection. The error increases inversely with the water depth, i.e. the shallower the water, the larger the error that can be induced by using DGPS over more accurate positioning.

However, many users do not have any better positioning capabilities than DGPS; how can they still obtain valid patch test results without having centimetric accurate positioning? This is, in large part, what this paper is concerned with. However, even with centimetric position, the following should be followed.

11.7.2 Feature chosen for test

Where at all possible, for latency, pitch and heading data collection, a feature should be used rather than a slope. Slopes tend to be too variable as opposed to a well-defined feature such as a wreck, rock outcrop or pipeline.

One of the other issues, with using a slope, is that many times the shallow end of the slope does not allow sufficient area or depth for the vessel to come about and line up for the reciprocal run; this does not allow sufficient time for the motion sensor to settle down nor for the helmsman to find a steady course.

It has been found that when using a slope, for the pitch calibration, that the heading angular offset can have a large influence. If the sonar head does not track exactly the same route, up and down the slope, the heading offset will affect the pitch angular result.

11.7.3 Water depth

The deeper the water, the better the result. In shallow water, DGPS wobble creates more, relatively severe, position errors. A corollary to this is that the subtended angle is proportionally

Version	3.3	Rev	r000
Date	13-04-2017		

larger in shallow water, which can blur the definition of the object used, be it a feature or slope. The shallower the water, the larger the subtended angle; the deeper the water, the smaller the subtended angle and, therefore, the better the definition of the object or slope.

11.7.4 Use predefined survey lines

The most important positioning issue is having the sonar head pass over the same exact location in both of the survey data collections. This is especially true when using a highly variable slope. One way to assist the helmsman is to give the helmsman a defined line to navigate by. Just trying to go over the same track, without a line reference, does not work, as it is the sonar head that has to pass over the same exact point; this accuracy cannot be obtained just by using the grid display to steer the vessel.

When setting up the survey software, make sure that the sonar head is the steered reference for all offline measurements. It does no good to have the vessel on the survey line, if the sonar is mounted on the side of the vessel; it is the sonar that should be on the survey line.

11.7.5 Speed

When doing the latency data collection, the fast run should be at survey speed where, if there is squat or settlement, it should have been previously measured and can be applied. Many times, the fast run survey line is at a speed that is greater than the normal survey speed and induces unknown squat and settlement errors into the computation.

11.7.6 Vessel line up

In order for the angular measurement to be accurate, the vessel should have sufficient time to come on line and allow the motion sensor to ‘settle down’. Sufficient lead/run in should also be allowed in order for the helmsman to find the proper heading so that vessel can maintain as straight a course as possible.

11.7.7 Pole variability

The other issue, which is often overlooked, is the variability in the repeat position of a deployable hydrophone pole. With any moveable mounting arrangement the pole should be recovered and redeployed a few times, during data collection, to determine if it does, indeed, go back into the same aspect every time that it is deployed. (It is a good idea, after redeploying the head, to do a few figure 8 manoeuvres.)

Version	3.3	Rev	r000
Date	13-04-2017		

11.8 Improving the Patch Test and Patch Test results

Section 11.7 described areas that should be addressed to improve the results of the patch test when collecting the data. Further improvement will come with the number of data collections and the manner in which the patch test is computed.

11.8.1 Need to collect sufficient data

Too many times, surveyors will collect just a few lines of data for each test. One of the major issues, detailed above, is the variability of the position accuracy of DGPS. Another issue, detailed above, is the steering of the vessel during the data collection and the relationship of the sonar head to the feature or slope on each data collection.

In order to overcome the variability of the DGPS positioning and vessel steering, it follows that the more tests that are performed, the greater will be the reliability of the test results. Below, is an example of a multibeam calibration, which included five data collections for each test.

ROLL	PITCH	YAW
0.73	-0.73	1.02
0.73	-0.99	0.90
0.76	-2.16	0.81
0.76	-1.07	2.26
0.74	-0.83	0.94

Pitch mean with erroneous value = -1.16 (SD = 0.58); without erroneous value of -2.16 = -0.91 (SD = 0.13) Yaw mean with erroneous value = 1.19 (SD = 0.61); without erroneous value of 2.26 = 0.92 (SD = 0.08)

Consider the above patch test and what the result would have been if only two collections were made and those were the ones that contained the highlighted values, which can clearly be seen to be outside of the trend. Having more data to work with, a more reliable result can be achieved.

The more data collected, the more evident will be any out of trend values that may reflect a DGPS wobble, a steering issue, or variability of the positioning of the pole. Enough data should be collected to provide a reliable statistical result, i.e. mean and standard deviation. Collecting enough data to compute six of each test, allows the exclusion of any one 'out of trend' result to yield a mean and standard deviation derived from five computations; this would be a statistically viable sampling.

11.8.2 Individually solving values

No matter what the solving order may be, each value should be computed independently. All tests should be based on the mean of the previous test(s).

It is important to understand why a certain solving order is used in all survey software. Each computation is based on the previous test result. This is the reason that latency is computed before pitch and roll is computed before heading; the primary test (latency or roll) has a large influence on the result for the secondary test (pitch and heading). The roll computation can also have an influence on the pitch computation, primarily if the position of the sonar head, of the reciprocal runs, was not coincident. The heading offset will also have an influence on the pitch computation for the same reason.

Generally, multibeam surveys are conducted with very accurate time synchronisation using GPS time and the Pulse Per Second. In this case, the latency test is used to prove the lack of latency or that is sufficiently small enough so as to be of no consequence. Using accurate timing, it is not necessary to collect more than two latency collections. This paper will concentrate on the angular offset computations. However, if accurate timing is not used there should be the same number of collections as with the other tests.

With a good number of individual tests, solve for one computation (i.e. only roll) and derive a mean and standard deviation for that one test. Determine if the standard deviation is within acceptable accuracy requirements, then use that derived mean to solve for the next computation (i.e. pitch). As an example, using the results on page 7, the first step would be to solve for Roll first, derive a Roll mean and then use that mean in all of the Pitch computations. Find the mean and standard deviation for Pitch. Use the mean Roll and Pitch values to determine the Heading offset.

In the above example, the roll mean, of the five tests, is 0.74° , with a standard deviation (δ) of 0.01° . The roll mean would now be used when determining the value for pitch. Use the roll mean and solve all of the pitch computations; the pitch mean is -0.91° (excluding the out of norm value), $\delta = 0.13^\circ$. The roll and pitch computed means are now used to solve for the heading offset. The solved heading offset is 0.92° , $\delta = 0.08^\circ$.

If the heading offset had been 1.5° or greater, it would be advisable to re-compute the pitch offset, using the computed heading offset value. This is due, again, to the fact that if the sonar head did not track the same exact position in the reciprocal runs, the heading offset will have an influence on the pitch offset result.

11.9 Truthing the patch test

After deriving the values for roll, pitch and yaw, the values should be entered into the appropriate areas in the data collection software. Ideally, find a singular object that can be boxed in (running data collection lines, on all sides of the object) and process the data. The object depiction, with all survey lines, should not vary from the object depiction from any one line.

Version	3.3	Rev	r000
Date	13-04-2017		

APPENDIX VI: Basic Acoustic Theory

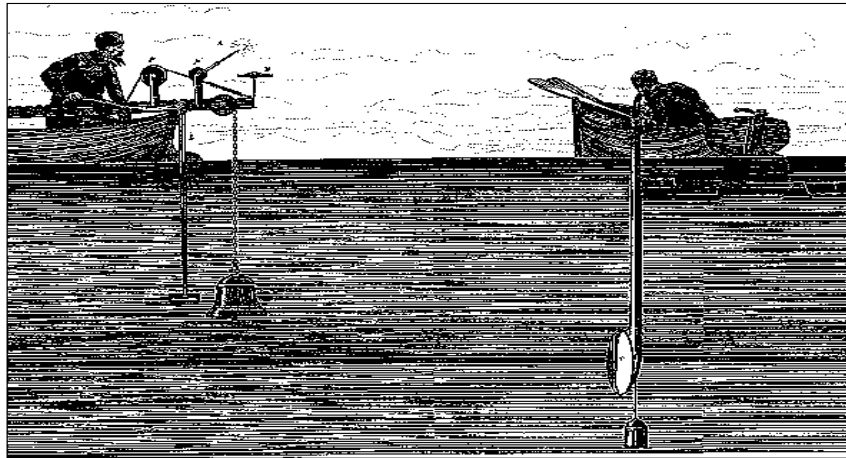

Figure 155: In 1822 Daniel Colloden measuring velocity in Lake Geneva.

(In 1822 Daniel Colloden used an underwater bell to calculate the speed of sound under water in Lake Geneva, Switzerland at 1435 m/Sec, which is very close to recent measurements)

12 APPENDIX VI: Basic Acoustic Theory

12.1 Introduction

With multibeam, as with any echosounder, a main concern is: sound in water. Once the projector transmits the acoustic energy into the water, many factors influence that energy's velocity and coherence. The major influence is the velocity of sound in water.

12.2 Sound Velocity

The major influence on the propagation of acoustic energy is the sound velocity of the water column. As the acoustic pulse passes through the water column, the velocity and direction (refraction) of the wave front will vary based on the water column sound velocity. If the sound velocity, through the water column, is not accounted for in the data collection software the depths and the depth location will be in error. For this reason, sound velocity casts are an oft repeated routine during multibeam survey.

Version	3.3	Rev	r000
Date	13-04-2017		

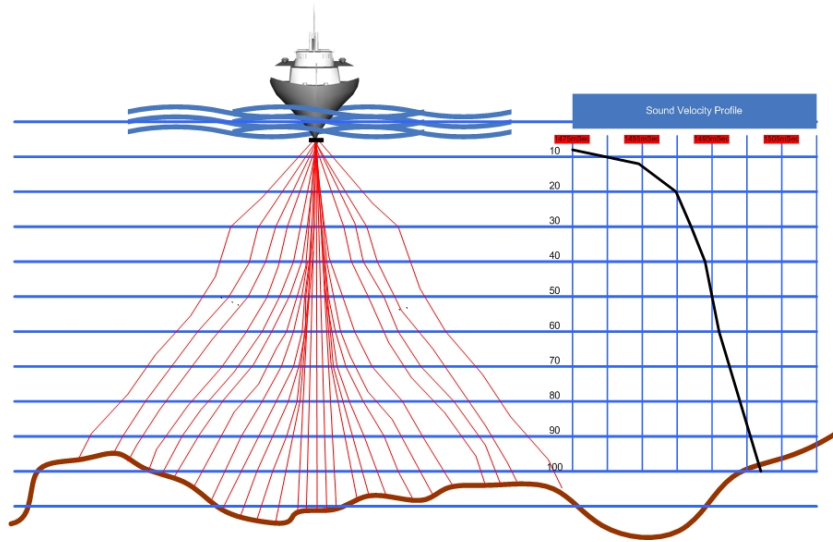

Figure 156: Concept of refraction due to different sound velocities in the water column

The velocity of sound in water varies both horizontally and vertically. It cannot be assumed that the velocity of sound in the water column remains constant over large areas or throughout the day in a more local area. The main influences on sound velocity are: Conductivity (salinity), Temperature and Depth (pressure).

- 1 ° C change in Temperature = 4.0 m/sec change in velocity
- 1 ppt change in Salinity = 1.4 m/sec change in velocity
- 100 m change in Depth (10 atm's pressure) = 1.7 m/sec change in velocity

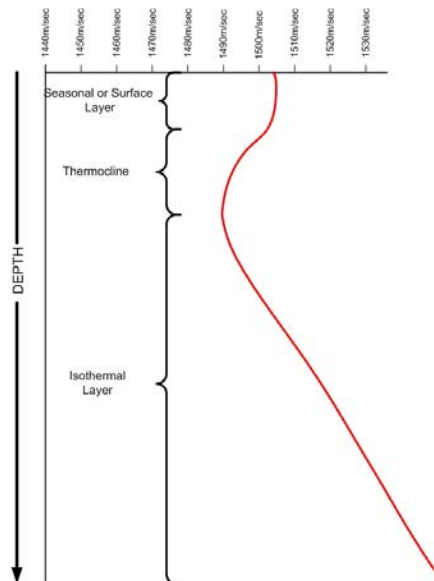

Figure 157: Sound velocity profile

Version	3.3	Rev	r000
Date	13-04-2017		

12.2.1 Salinity

Generally, salinity ranges from 32 – 38 parts per thousand (ppt) in ocean water. A change in salinity will create density changes, which affect the velocity of sound. As a general rule, a change in salinity of only 1 ppt can cause a sound velocity change of 1.4m/sec. There are many influences on the salinity concentration in sea water.

1. Evaporation
2. Precipitation
3. Fresh water influx from rivers
4. Tidal effects (salt wedges)

12.2.2 Temperature

Temperature is the major influence on sound velocity in water. A 1°C change is equal to approximately a 4m/sec change in velocity. Once the upper layer is passed, the temperature normally decreases until pressure becomes the more dominating influence on the velocity of sound, which is approximately at 1000 metres. The normal influences on the temperature component of sound velocity include:

1. Solar heating
2. Night time cooling
3. Rain / run off
4. Upwelling

12.2.3 Refraction Errors

Refraction errors occur due to the wrong sound velocity profile being applied to the data. The error increases away from nadir and, as such, is more apparent in the outer beams. The visual effect is that the swath will curl up (smile) or curl down (frown). The actual representation is that the soundings are either too shallow or too deep.

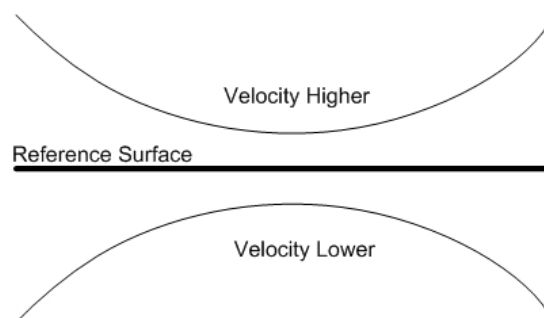

Figure 158: Refraction Error indication

At an angle of 45° in 10 meters of water, a ±10 meters per second velocity error will result in a depth error on the order of ± 4.6 cm. .

- Convex (smiley face) = Sound velocity profile used higher than real profile
- Concave (frown face) = Sound velocity profile used lower than real profile

Version	3.3	Rev	r000
Date	13-04-2017		

12.3 Transmission Losses

The transmission of an acoustic pulse is generally called a ‘ping’. When the projector sends out the acoustic pulse many factors operate on that pulse as it moves through the water column to the bottom and also on its return upward. The major influence of the water column sound velocity characteristics was detailed above; this affects the speed of transmission (and return). There are other influences that will affect acoustic energy in water and these are transmission losses.

12.3.1 Spreading Loss

Spreading loss does not represent a loss of energy, but refers to fact that the propagation of the acoustic pulse is such that the energy is simply spread over a progressively larger surface area, thus reducing its density. Spreading loss is not frequency dependent.

12.3.1.1 Spherical Spreading

Spherical spreading loss is the decrease in the source level if there are no boundaries (such as the water surface or sea floor) to influence the acoustic energy; all of the acoustic energy spreads out evenly, in all directions, from the source. The loss in intensity is proportional to the surface area of the sphere. The intensity decreases as the inverse square of the range for spherical spreading. With Spherical spreading, the transmission loss is given as: **TL = 20log(R)**, where R is range

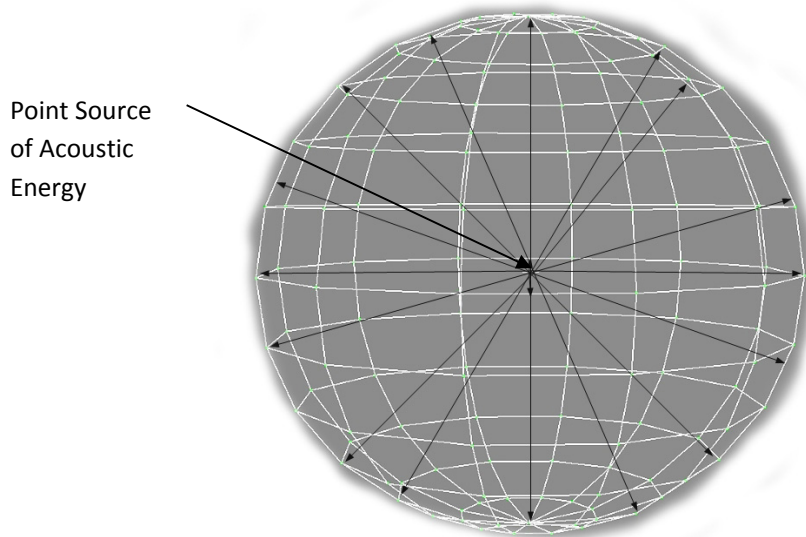

Figure 159: Concept of Spherical Spreading

12.3.1.2 Cylindrical Spreading

In reality the acoustic energy cannot propagate in all directions due to boundaries such as the sea floor and the water surface; this give rise to Cylindrical Spreading. Cylindrical spreading is when the acoustic energy encounters upper and lower boundaries and is ‘trapped’ within these boundaries; the sound energy begins to radiate more horizontally away from the source. With Cylindrical spreading the acoustic energy level decreases more slowly than with Spherical spreading. With Cylindrical spreading, the transmission loss is given as: **TL = 10log(R)**, where R is range.

Version	3.3	Rev	r000
Date	13-04-2017		

Part No. 96000005

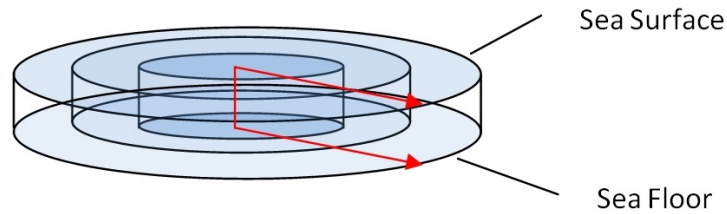

Figure 160: Concept of Cylindrical Spreading

12.3.2 Absorption

Absorption is frequency dependent and refers to the conversion of acoustic energy to heat when it strikes chemically distinct molecules in the water column. Magnesium Sulphate $MgSO_4$ predominates, with Boric Acid $B(OH)_3$ playing a major part at lower frequencies. Temperature is also an influence on absorption. Absorption is one of the key factors in the attenuation of the acoustic energy based on frequency; the higher the frequency, the greater the absorption. The higher the sonar operating frequency, the more rapid the vibration (or excitement) of the particles in the water and this leads to the greater transference of acoustic energy; thus, the attenuation of the acoustic wave. This is the reason why lower frequencies are used to obtain deeper data. At 400 kHz, the normal seawater absorption is approximately 100 dB/km, whereas at 200kHz the absorption is approximately 50 dB/km. These are values for normal sea water (with a salinity of 35 ppt). Fresh water has little, if any salinity (<0.5ppt), so absorption is considerably less.

Version	3.3	Rev	r000
Date	13-04-2017		

The below table and charts illustrate how frequency, water temperature, and salinity affect absorption

Seawater Absorption Values: Salinity = 35ppt, pH=8²											
dB/km											
400kHz						200kHz					
Temp (C)	5°	10°	15°	20°	25°		5°	10°	15°	20°	25°
Depth (m)											
50	97	100	111	130	154		46	56	68	80	89
100	96	100	110	128	153		46	55	67	79	88
150	96	99	110	128	152		46	55	66	78	88
200	95	99	109	127	151		45	55	66	78	87
250	95	98	109	126	150		45	54	66	77	86
300	95	98	108	125	149		45	54	65	77	86
						400m	44	53	64	76	84
Mean Value	96	99	110	127	152		45	55	66	78	87

Freshwater Absorption Values: Salinity = 0.5ppt, pH=7											
dB/km											
400kHz						200kHz					
Temp (C)	5°	10°	15°	20°	25°		5°	10°	15°	20°	25°
Depth (m)											
50	65	55	46	39	33		17	14	12	10	9
100	65	54	46	38	33		17	14	12	10	9
150	65	54	45	38	33		17	14	12	10	9
200	65	54	45	38	32		17	14	12	10	9
250	65	54	45	38	32		16	14	12	10	9
300	64	54	45	38	32		16	14	12	10	9
Mean Value	65	54	45	38	33		17	14	12	10	9

Table 13: Absorption Values for Seawater and Freshwater at 400 kHz and 200 kHz

² Equation used for computation is from: Ainslie M.A., McColm J.G., "A simplified formula for viscous and chemical absorption in sea water", Journal of the Acoustic Society of America, 103(3), 1671-1672 as employed on the NPL website, op cit.

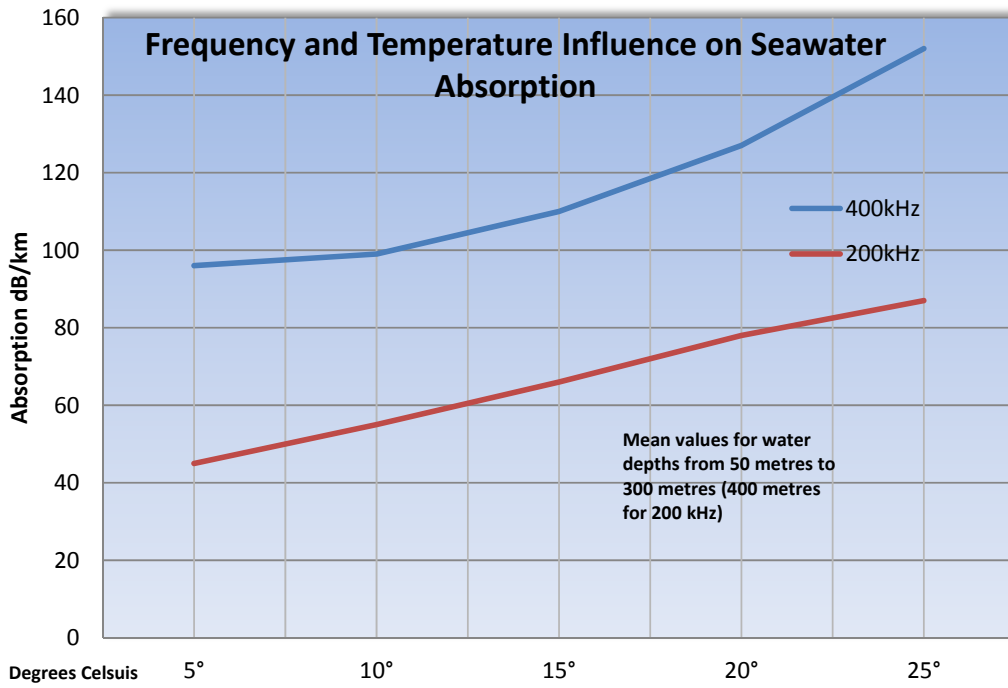

Graph 5: Seawater Absorption (Salinity 35ppt)

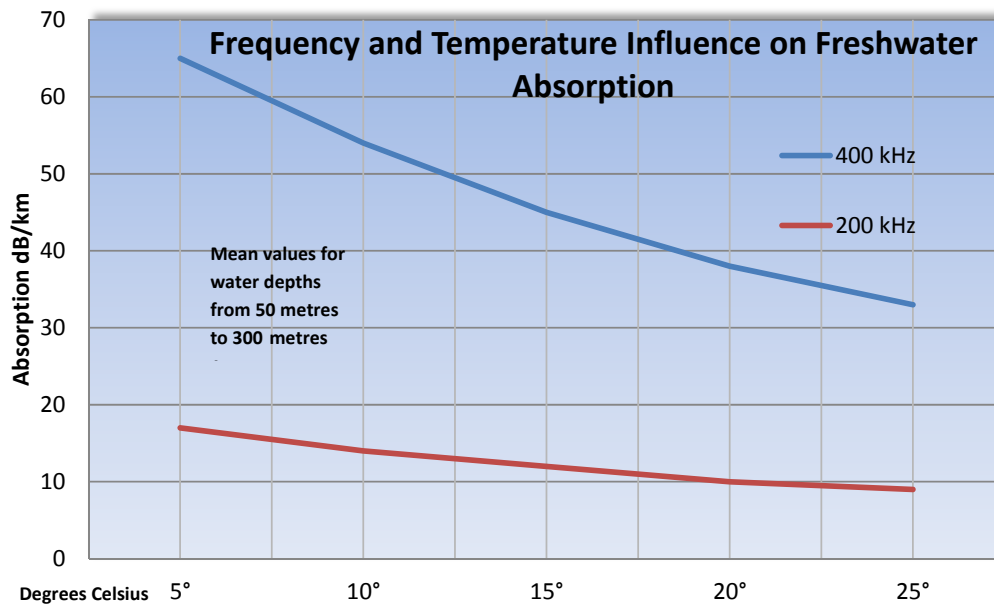

Graph 6: Freshwater Absorption

Version	3.3	Rev	r000
Date	13-04-2017		

These curves use the Francois-Garrison equations to estimate absorption in water. The family of curves are from 0 to 40 ppt in 5 ppt steps.

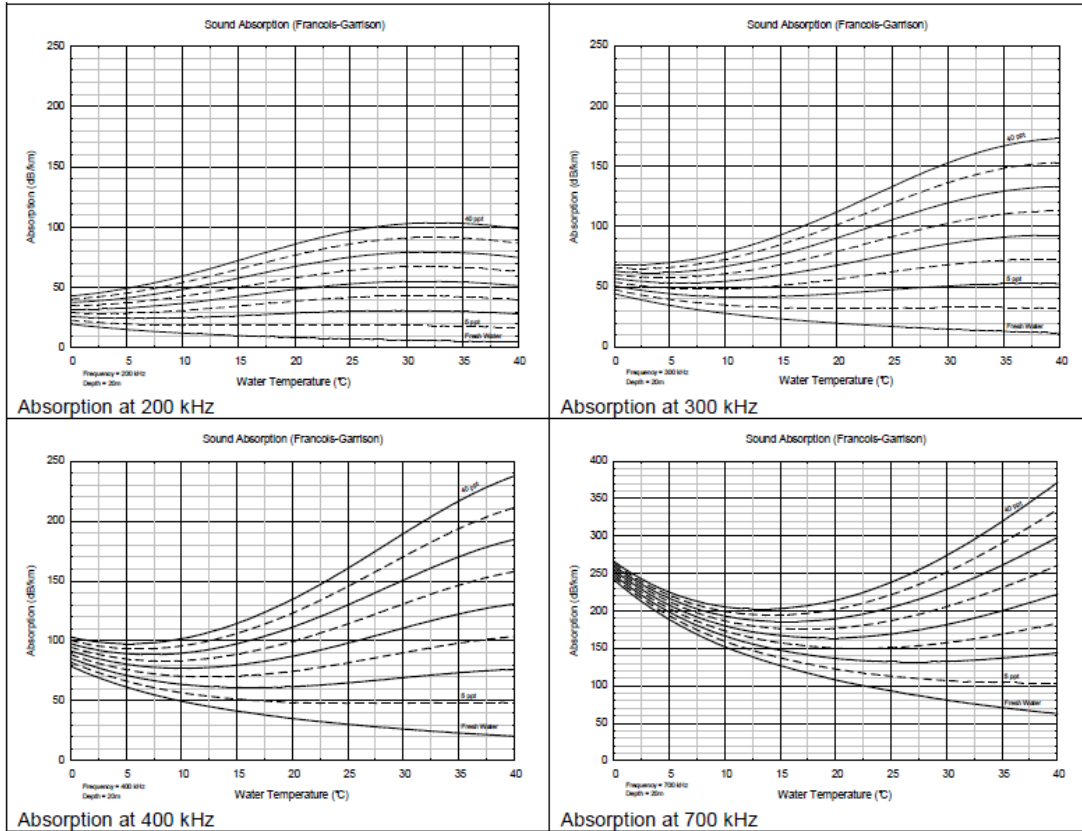

Notes:

1. ph = 8.0
2. These graphs fall outside of the recommended ranges for temperature and salinity. However, the values should be close enough for general use.

Figure 161: Sound Absorption Graphs

Version	3.3	Rev	r000
Date	13-04-2017		

Part No. 96000005

Seawater Absorption dB/km					
Freq.	10°C	15°C	20°C	25°C	30°C
200	55	67	80	89	92
210	57	69	82	94	98
220	59	71	85	97	104
230	61	74	88	101	109
240	63	76	91	105	115
250	65	78	94	109	120
260	67	80	96	113	125
270	69	82	99	116	130
280	71	84	101	120	134
290	73	86	104	123	139
300	75	88	106	126	143
310	78	91	108	129	148
320	80	93	111	132	152
330	82	95	113	135	156
340	85	97	115	138	160
350	87	99	118	141	164
360	90	102	120	143	168
370	92	104	122	146	171
380	95	106	125	149	175
390	98	109	127	152	179
400	100	111	129	154	182
700	213	207 ³	214	235	270

Table 14: Operating Frequency - water temperature - absorption

³ At 700 kHz, there is an absorption dip, in this temperature range

12.3.3 Reverberation and Scattering

The sea is not homogenous in nature. Everything from suspended dust particles to fish, from the sea surface to the sea floor will scatter, that is reradiate, the acoustic energy. All of the effects of individual scattering can be termed reverberation. The effect of reverberation is to lessen the acoustic energy and this leads to transmission losses.

Reverberation is divided into three main areas: sea surface reverberation, bottom reverberation, and volume reverberation (the body of water that the energy is passing through).

Both the sea surface and the sea bottom will reflect and scatter sound, thus affecting the propagation of sound. Sea surface scattering is influenced by how rough the sea is (which is related to wind velocity) and also the trapped air bubbles in the near surface region. The sea surface is also a good reflector of acoustic energy; this can lead to second and even tertiary bottom returns as the bottom return acoustic energy is reflected by the sea surface and is then reflected once more by the sea bottom.

In the case of the sea floor, the strength of the scattering depends on the type of bottom (composition and roughness), the grazing angle of the acoustic pulse and the operating frequency of the sonar.

There is also bottom absorption based on the sea floor terrain and composition. Bottom absorption is also dependent on the operating frequency of the sonar and the angle of incidence. Bottom absorption will be greater for a higher frequency and large angle of incidence. It is more or less intuitive that a mud bottom will absorb more of the acoustic energy than a rocky bottom. When the acoustic energy is absorbed it means there is less that will be reflected back to the Sonic 2020's receivers. The surveyor must be aware of the bottom composition as adjustments can be made to the Sonic 2020 operating parameters to help compensate for the bottom absorption.

In waters with a large sediment load, the suspended particles will scatter the sound wave, thus leading to transmission loss. In the scattering process, there is also a degree of energy that it is reflected (backscatter); this can be a cause for 'noise' in the sonar data. Again, the surveyor should be aware of this condition and, if need be, change the operating parameters of the Sonic 2020. When discussing the changing of the operating parameters, it is generally a matter of increasing transmit power or pulse length to get more total power into the water. In some circumstances, increasing the Absorption value will allow the system to rapidly increase gain to capture the reflected energy that has been dissipated by seafloor absorption or scattering in the water column.

As noted above many of the effects of absorption, scattering, and bottom absorption are frequency dependent. With the Sonic 2020, the operator can adjust the sonar frequency to optimise the system for the survey conditions. This will take some trial and error; however, lower frequencies tend to do best in areas of absorbent bottom and high sediment load (scatter).

Version	3.3	Rev	r000
Date	13-04-2017		

Part No. 96000005

Appendix VII ROV and AUV Installation

13 APPENDIX VII: Sonic 2020 Mounting: Sub-Surface (ROV/AUV)

13.1 Installation Considerations

- A 1000BASE-T link (best time sync accuracy) is preferred; however, with bathymetry only information, 100BASE-T will work. 10BASE-T will also work, but is not recommended. Bath data requires 2 Mb/s data rate at a maximum ping rate of 60 pings/sec. For future compatibility, please use 100BASE-T at minimum, Snippets will not work with 10BASE-T; however, Snippets will work over a 100BASE-T link.
- Average power, for the Sonic 2020 is 22W (0.46A), peak is 29W (0.60A). The peak power occurs just after transmit and typically lasts for a few msec (depends on transmitter power setting).
- The sonar up/down link is all done through the Ethernet channel. Thus, no other hardware is required except for the Ethernet media converters (copper to fibre, fibre to copper). As a precaution, placing additional filtering on the output of the 48V supply to the sonar head is a good idea to prevent vehicle electronic noise from getting into the sonar head. A common mode choke, on the 48V line, is recommended. The Bourns (JW Miller) PM3700-50-RC common mode choke works well (surface mount part). A Bourns 8102-RC choke, which is easier to install (non-surface mount) can also be used.
- The supplied deck cable is a special cable with Ethernet pairs which is rated to 100 meters water depth. **Do not substitute this cable, as the Ethernet data pairs need to meet certain important specifications.** When terminating the Ethernet connections to your own connector, **the Ethernet twisted pairs need to terminate right at the connector pins**, maintaining the twist on the wires as close to the connector pins as possible. On the bulkhead connector, **use CAT5, or better** Ethernet cable, from the connector, to the Ethernet media converter. Use adjacent pins for each wire pair. If 100BASE (or 10BASE) Ethernet is used, only the green and orange pairs are required. All four pairs, including blue and brown, are only required when using gigabit Ethernet.
- **Using a connector with a pigtail spliced on to the deck leads' Ethernet pairs has a low probability of working.** If the deck lead must be terminated to a pigtail, the pigtail length must be as short as possible, probably no more than 7-8cm. There are no special considerations for the power conductors other than the connector being able to handle 48VDC and 2 amperes. The drain (shield) wire does not need to be terminated.

Version	3.3	Rev	r000
Date	13-04-2017		

13.1.1 Ethernet wiring considerations

The sonar head and SIM use gigabit Ethernet ports. There are rules, regarding number of pairs of wire to use, between different Ethernet ports, those rules are:

- **Gigabit to Gigabit**

Need all four pairs. If only two pairs used, in an attempt to force the ports to 100BASE-T, the ports will not negotiate and the result will be no connection. (As of the 16Nov2013 head firmware, two pairs can be used; this will put the head in a 100BASE-T connection.) Sometimes it's not obvious if a port is Gigabit enabled; the Status display shows the Ethernet connection speed for the head. This is useful for troubleshooting connection issues.

- **Gigabit to 100BASE-T**

Two pairs (green and orange on TIA/EIA-568-B wiring) can be used. Be sure to test this with a modified patch cable (cut the brown and blue pairs) before committing to the chosen Ethernet equipment as there may be surprises hidden in the equipment.

- **100BASE-T to 100BASE-T:**

You can use two pairs (green and orange, T568B).

When connecting to the SIM, use either of the AUX Ethernet ports for the sonar head Ethernet connection.

13.2 Data Rates

Bathy: ≈800 kb/s max (bathy data is sent twice, to GUI and data acquisition computer)

Snippets: ≈11Mb/s max

TruePix™: ≈ 5.5 Mb/s (magnitude +angle) max
≈ 3.5 Mb/s (magnitude) max

Water Column: ≈280 Mb/s max for magnitude only
≈560 Mb/s max for magnitude + phase

The data rate, for water column data, can be significantly reduced by increasing the pulse width. At certain pulse widths, the receiver sampling rate halves, which will make the water column data rate halve.

As an example:

Pulse width 15µsec - 30µsec: 65 kHz sample rate = Ethernet: 35 Mb/sec (amplitude) 280 Mb/s (amplitude and phase)

Pulse width 35µsec - 70µsec: 32.5 kHz sample rate = Ethernet: 17.5 Mb/s (amplitude), 140 Mb/s (amplitude and phase)

Version	3.3	Rev	r000
Date	13-04-2017		

Part No. 96000005

13.3 ROV Installation Examples

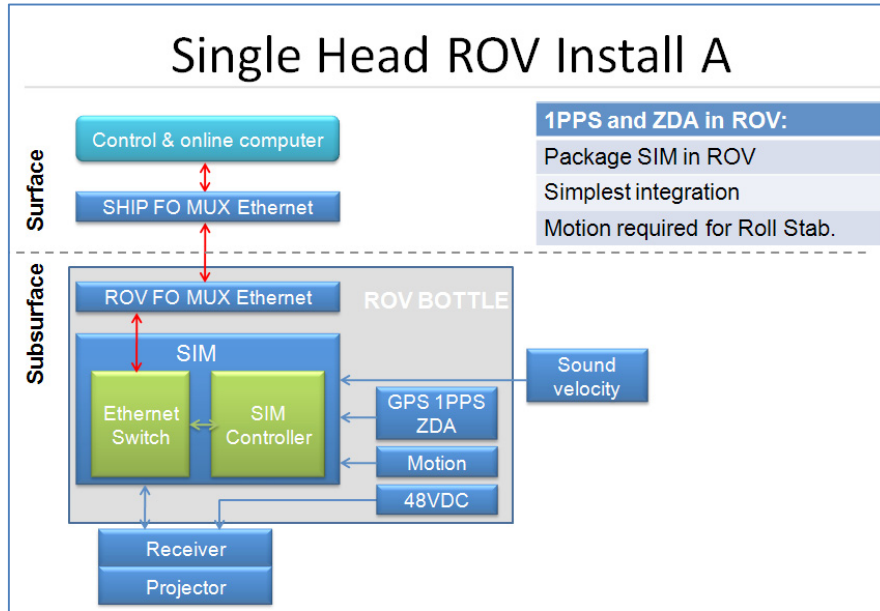

Figure 162: Single Head ROV Installation scheme A

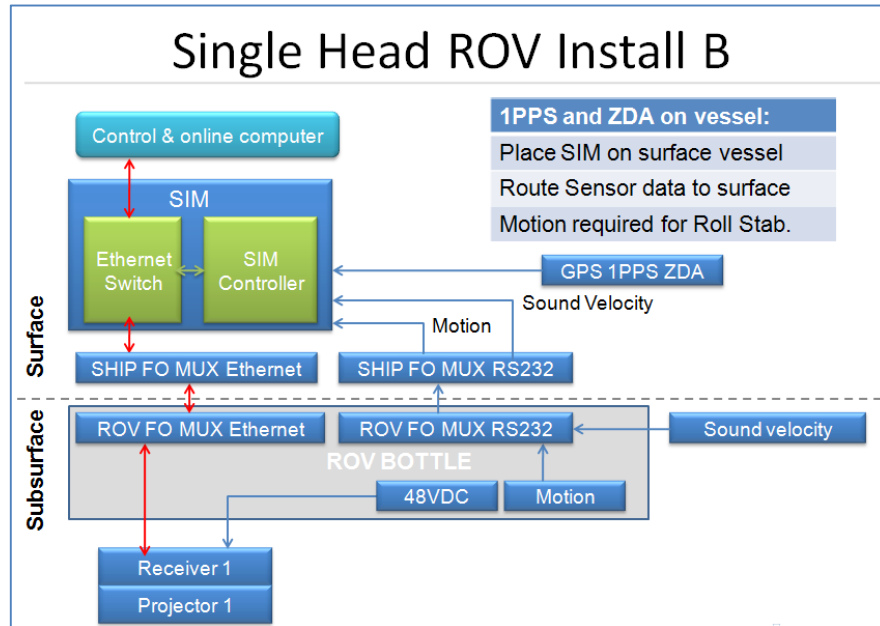

Figure 163: Single Head ROV Installation scheme B (Preferred)

Version	3.3	Rev	r000
Date	13-04-2017		

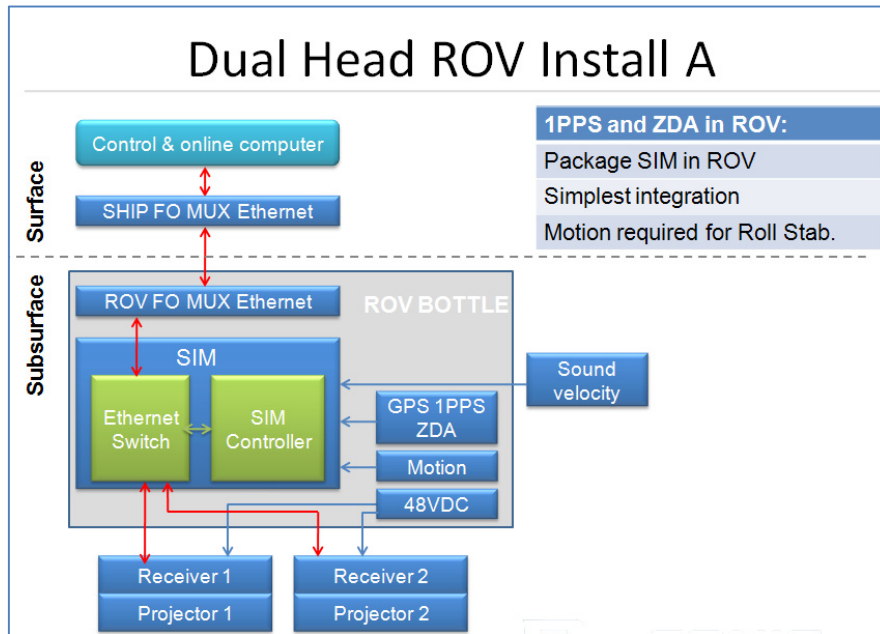

Figure 164: Dual Head ROV Installation scheme A

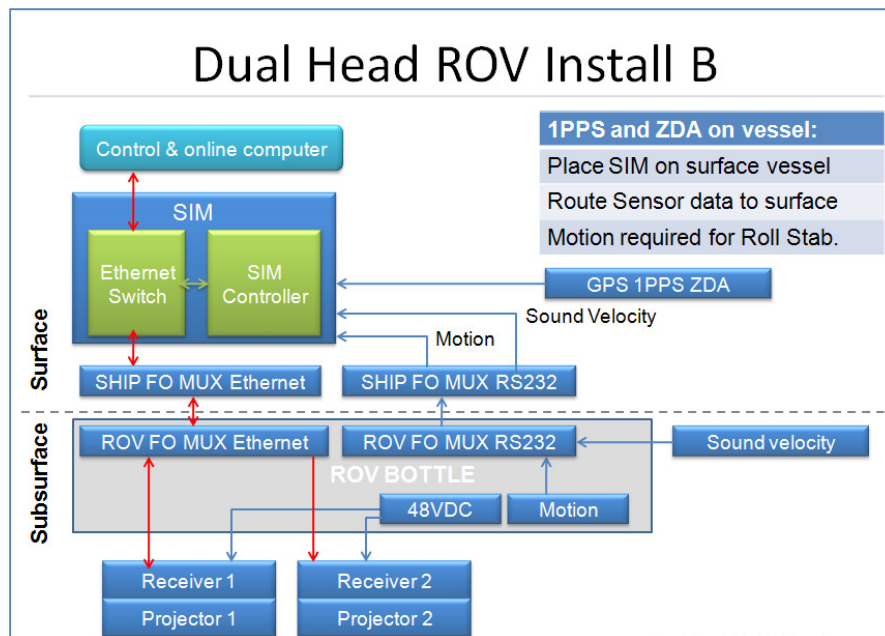

Figure 165: Dual Head ROV Installation scheme B (Preferred)

13.4 Power Requirements

The basic over the side installation of the Sonic 2020 systems consists of the sonar head, SIM box, sound velocity probe, and interconnecting cables. The sonar head, SIM, and computer(s) communicate via 100BASE-T or 1000BASE-T (Gigabit) full duplex Ethernet.

Installation in an ROV requires an Ethernet media converter to convert copper to fibre optic and back to copper media to accommodate long tethers. On shorter ROV tethers (less than 1000 metres), using impedance controlled twisted-pair copper wire and a DSL modem may be possible.

Remote or autonomous vehicles typically supply the 48 volt power to the sonar head, and if required, the SIM Controller board.

Device	Power	Conditions
2020 with SIM	95 to 260VAC, 48.5 W	2020 head connected to SIM, equivalent to over the side installation. Conditions: 400kHz, 30m range, Tx power = 207 dB, pulse width = 50us.
SIM	95 to 260VAC, 16.5 W	No connections to SIM
2020 head	at 48V 0.46 A average 0.60 A peak after transmit	30m range, Tx power = 207 dB, pulse width = 50us.
SIM control board	48V, 78mA (gigabit) 48V, 51mA (100BASE-T)	No connections except Ethernet.

Table 15: Systems Power Requirements

In an ROV or AUV installation, the sonar head and SIM Controller board require 48VDC which is supplied by the vehicle power system. The average power required is 20 watts for the 2020. Just after transmit, an additional 9 watts is required to charge the transmit capacitor bank for a brief period of time. See below figures for current waveforms. If a separate power supply for the sonar is required, it should be rated for 100 watts or higher.

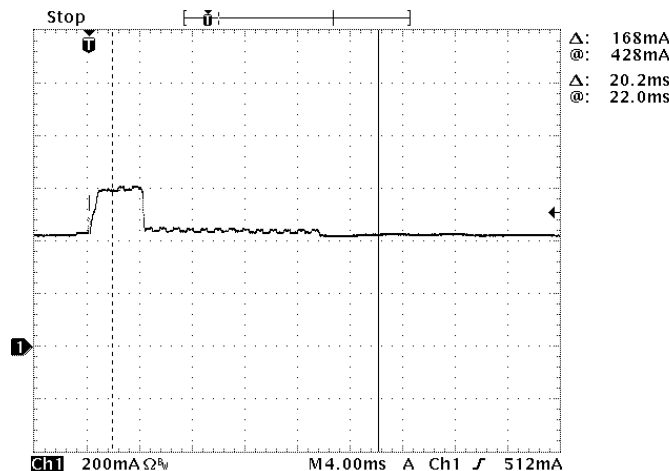

Figure 166: Sonic 2020 power supply current waveform. Peak current is 0.60A at 48V.

Sonar setting: 50µsec Pulse Width, 207dB TX Power and 400 kHz Operating Frequency

Version	3.3	Rev	r000
Date	13-04-2017		

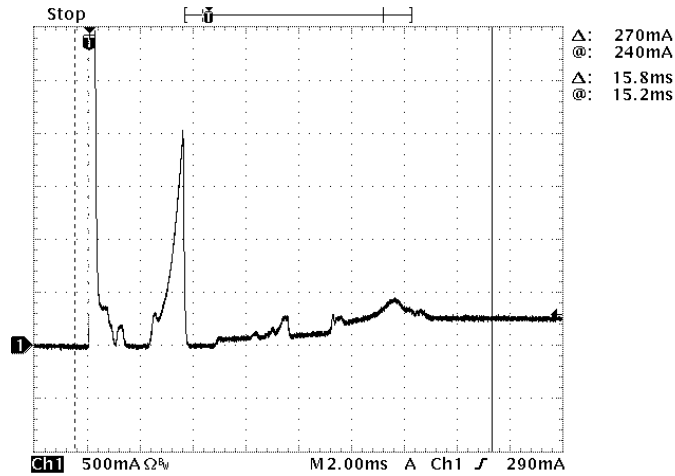

Figure 167: Inrush current to 2020 head during power up, 20 ms window.

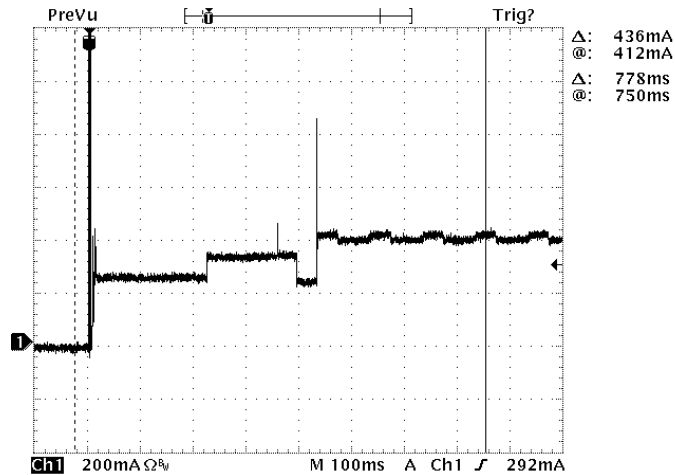

Figure 168: Inrush current to the 2020 head during power up, 1 second window.

13.4.1 Common mode noise rejection

Common mode noise on the 48VDC power line to the sonar head should be minimized. The SIM Controller board has a common mode choke on the power line to the sonar head. If sonar head power is not supplied by the SIM Controller board, install a common mode choke on the sonar head 48VDC power line. A suitable common mode choke is JW Miller (Bourns) 8102-RC. This is available from Digi-Key. See below figure for wiring details.

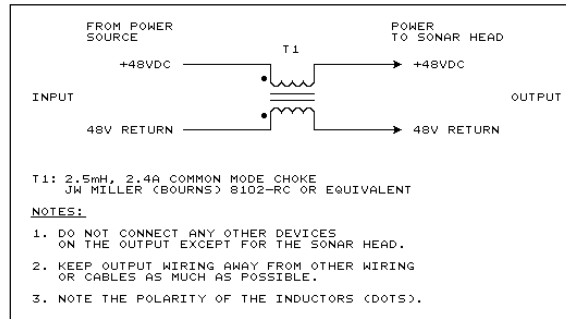

Figure 169: Power supply choke installation on 48VDC power

13.4.2 SIM Power connections

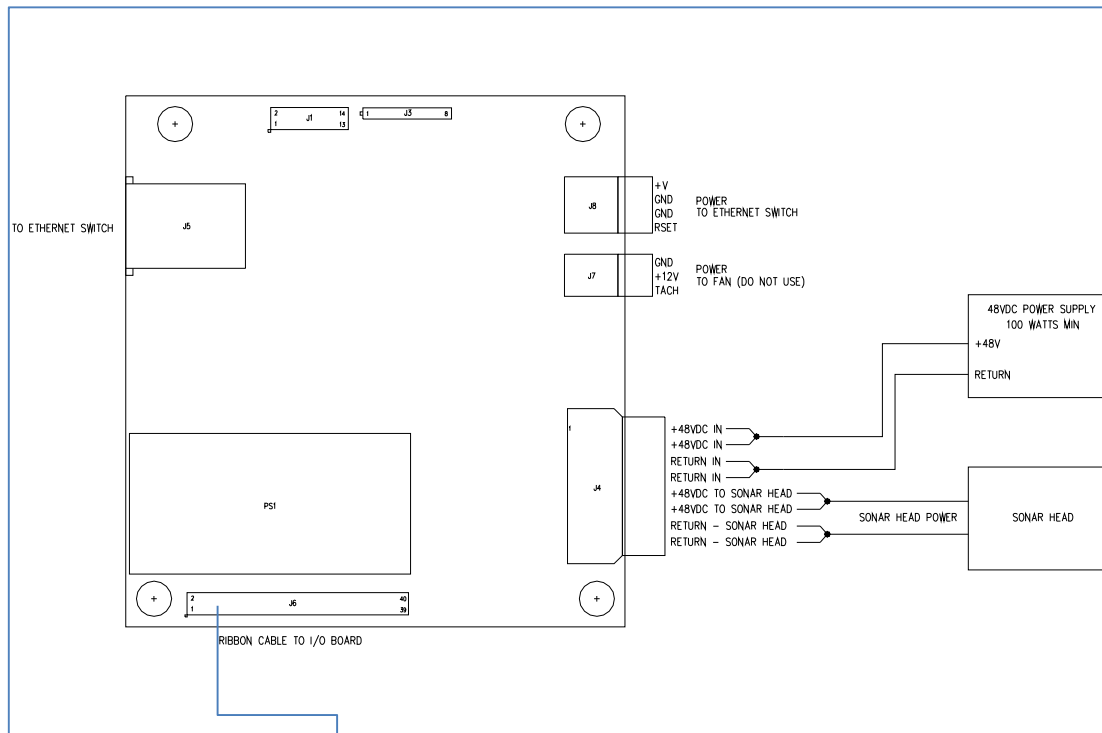

Figure 170: SIM Controller Power Connections

J6	
+3.3V OUT	1 2 +3.3V OUT
GND	3 4 SRDAT
GND	5 6 SRCLK
GND	7 8 SREN
GND	9 10 SRCHK
GND	11 12 BNC1 (PPS)
GND	13 14 BNC2 (SYNC IN)
GND	15 16 BNC3 (SYNC OUT)
GND	17 18 n/c
TxD1 (GPS)	19 20 RxD1 (GPS)
TxD1 (MOTION)	21 22 RxD1 (MOTION)
TxD2 (MOTION)	23 24 RxD2 (MOTION)
TxD2 (HEADING)	25 26 RxD2 (HEADING)
TxD3 (SVP)	27 28 RxD3 (SVP)
TxD3 (HEADING)	29 30 RxD3 (HEADING)
TxD4 (SVP)	31 32 RxD4 (SVP)
TxD4 (HEADING)	33 34 RxD4 (HEADING)
+12V OUT	35 36 +12V OUT (SVP PWR)
n/c	37 38 n/c
GND	39 40 GND (SVP PWR)

2x20 PIN, 2mm HEADER

The mating connector for J4:
Molex 43645-0800 (8-way Micro-FIT 3.0)
Molex 43030-0009 (socket contacts)
Molex 63819-0000 or 63811-2800 (crimping tool for socket contacts)

The mating connector for J6:
Amp 2-111623-4
Any 2mm 2x20 header connector may be used for this part.
1mm pitch ribbon cable is also required

Figure 171: J6 Connector on SIM Controller board

Version	3.3	Rev	r000
Date	13-04-2017		

13.5 SIM Installation – ROV

The SIM can be installed either top-side or in the vehicle. There are advantages to both methods which depend on the multiplexer capabilities. For SIM installation in the vehicle, the SIM Controller board may be removed from the SIM or supplied as an additional item. The SIM controller board uses a PC/104 size format, but does not use the PC/104 bus.

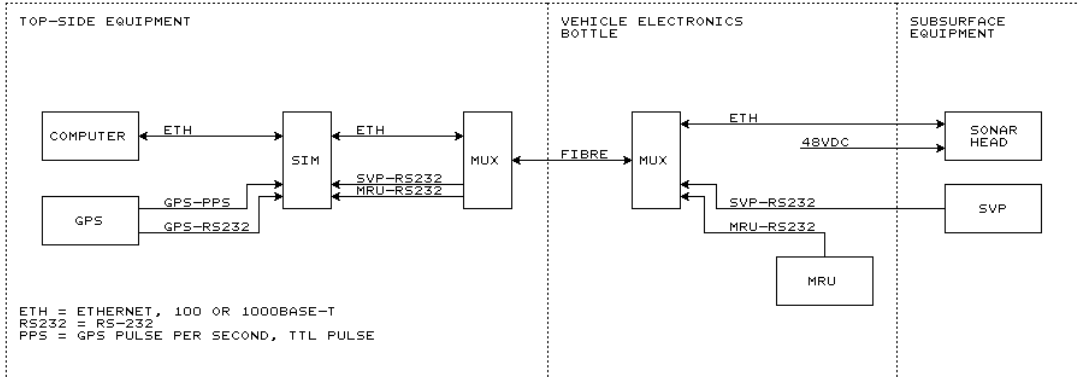

Figure 172: ROV installation block diagram with the SIM top-side

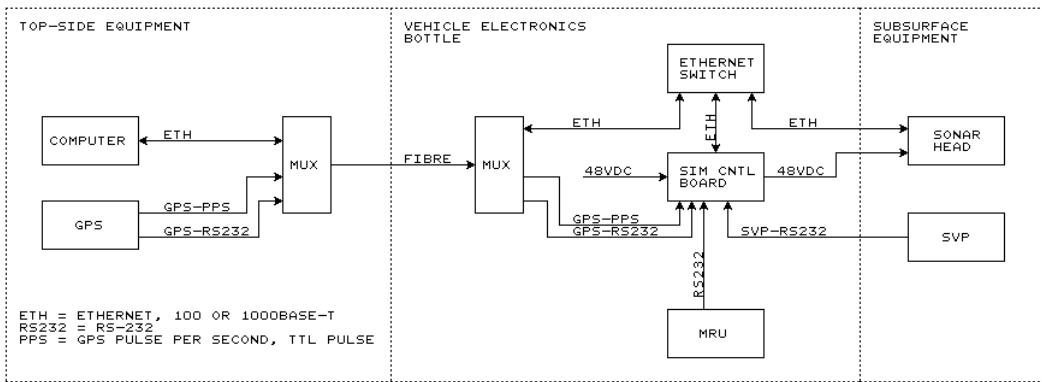

Figure 173: ROV installation block diagram with the SIM controller board mounted in the vehicle electronics bottle and GPS (ZDA or UTC formats) and PPS signals are supplied by top-side equipment

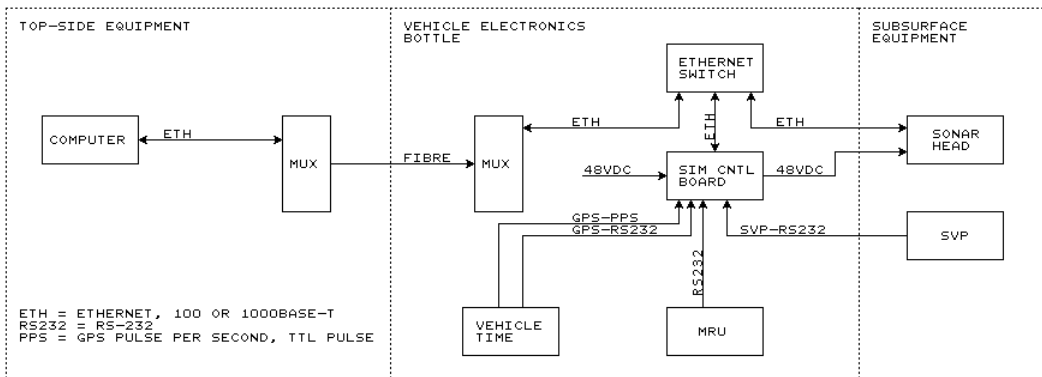

Figure 174: ROV installation block diagram with the SIM controller board mounted in the vehicle electronics bottle. GPS (ZDA or UTC formats) and PPS signals are supplied by the vehicle time system.

13.6 SIM Installation – AUV

The circuit boards, inside the SIM, can be supplied separately as shown in Fig 125. The three boards use a PC/104 size format, but do not use the PC/104 bus. The three boards are the I/O board where the customer connects time, motion and sound velocity sensors; SIM Controller board; and a gigabit Ethernet switch.

It's best that the SIM Controller board supply power to the sonar head as the controller board has a common mode choke for the 48 VDC power to the sonar head and the SIM Controller board can control power to sonar head. If the customer uses their own custom data acquisition software, a list of commands for the sonar head and SIM are in [Appendix VIII](#). The uplink data format is provided in [Appendix IX](#).

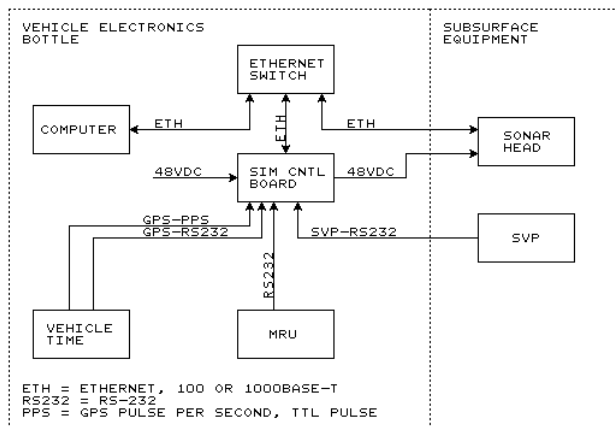

Figure 175: Typical wiring. GPS (ZDA or UTC formats) and PPS signals are supplied by the vehicle time system



Figure 176: SIM Board Stacks

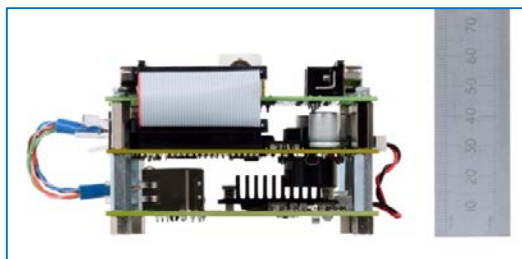

Figure 177: SIM Stack Height

SIM board stacks:
 Top board: I/O
 Middle board: SIM controller
 Bottom board: Gigabit, 5-Port, Ethernet switch

BNC connector: GPS PPS input
 SMB connectors: sync in and out

Version	3.3	Rev	r000
Date	13-04-2017		

13.7 SIM Board Physical Installation

1. Power requirements: 48VDC, 50 watts average, 100 watts peak.
2. **36VDC is absolute minimum working voltage; 52VDC is absolute maximum working voltage**
3. All boards are static sensitive. People handling the boards should be properly grounded.
4. User has the option to use the I/O board or not. The I/O board is connected to the SIM Controller Board via a ribbon connector (SIM Controller J6 and I/O board J14).
5. For an AUV setup, the Ethernet connections are not used on the I/O board. The Ethernet connections are made directly to the Ethernet Switch board.
6. If the I/O board is not used, direct connections to J6, on the SIM Controller, can be made. One level of static protection is removed if the I/O Board is not used; however, there is enough protection for small static events on J6.

13.8 SIM Stack LED Status Indicators

On the I/O board (top board) with nothing connected except for power:

- On power up, all the LEDs will first glow red for 0.5 second, then green for 0.5 second
- Then, they will indicate the activity level of each input.
- With no inputs, PPS, GPS, Motion, SVP LEDs will glow red.
- Trigger (sync) out will glow green.
- Heading and trigger (sync) in will be off.
- Power will be orange (red and green on) if no head is connected.

On the SIM Controller board (middle board):

- The first LED should be glowing red (not blinking). This indicates the 3.3V power supply is working.
- The fifth LED will blink a Morse code message. This indicates that the FPGA code is running.
- All other LEDs are off.

The Gigabit switch board Ethernet Speed (bottom board):

Left LED	Right LED	Status
OFF	OFF	No Link
ON	OFF	10Base-T
ON	ON	100Base-T
OFF	ON	1000Base-T

Table 16: SIM Gigabit switch speed indicators

13.8.1 SIM Board Dimensional Information

Dimensions are given in inches [millimetres]

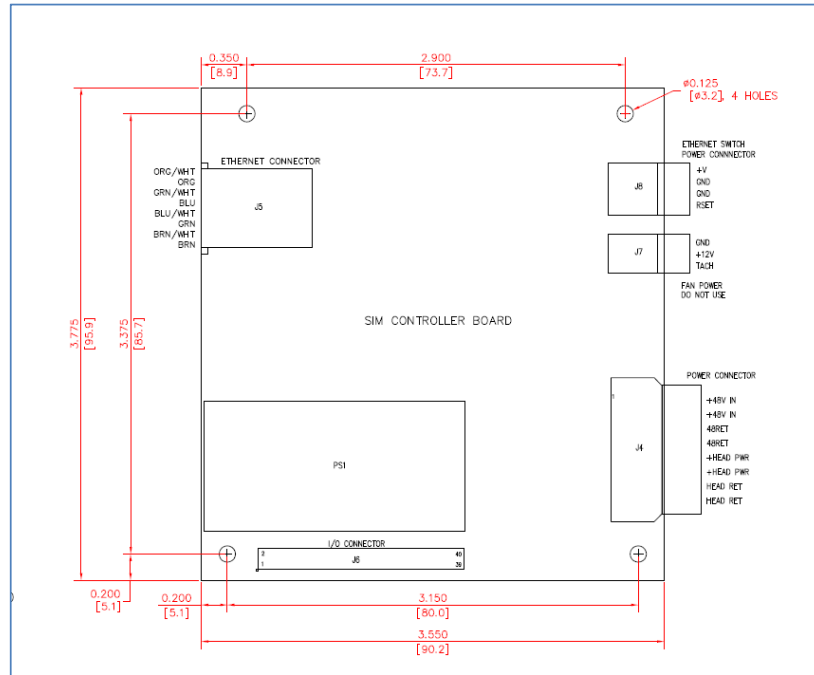

Figure 178: SIM Controller Board installation dimensions

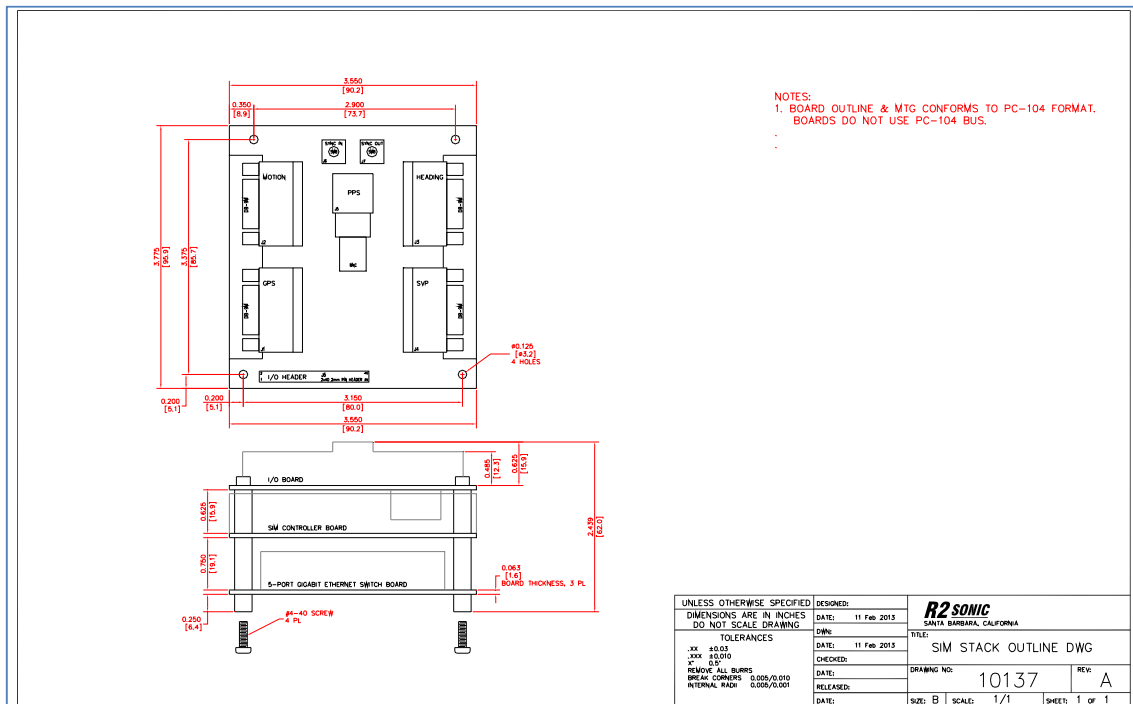

Figure 179: SIM Stack Outline

Version	3.3	Rev	r000
Date	13-04-2017		

13.8.2 SIM Board Images

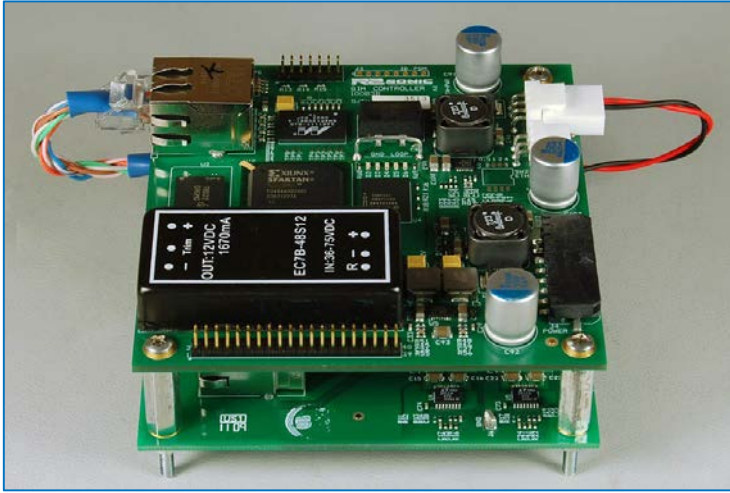
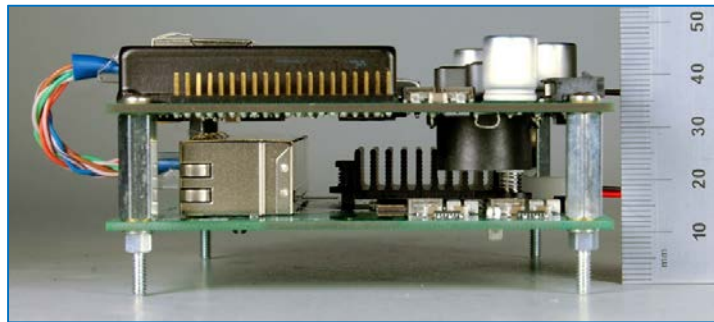

Figure 180: Assembled SIM Boards

Figure 181: SIM Boards height



Version	3.3	Rev	r000
Date	13-04-2017		
Part No. 96000005			

13.9 Dual Sonar Head

13.9.1 Dual Head Installation

The R2Sonic family of multibeams can be installed in a dual head configuration, either pointing inwards or directed outwardly, depending on the customer’s survey task. In dual head mode, the individual sonar heads can either ping simultaneously (with frequency offset) or alternate pings (same frequency). The dual head configuration is comprised of two sonar heads, either a single SIM or dual SIM boxes and one Sonic Control 2000. **The same exact head firmware must be installed on the sonar heads in order for Sonic Control to operate the sonar heads.**

13.9.2 Operation

13.9.2.1 Load Dual Head Factory Default Settings

The factory default settings, for dual head mode, will populate the default IP addresses and UDP ports for all systems. Go to File | Load Settings, there will be three .ini files; load the desired DefaultSettingsDualHead initialisation file (Dual SIM or Single SIM).

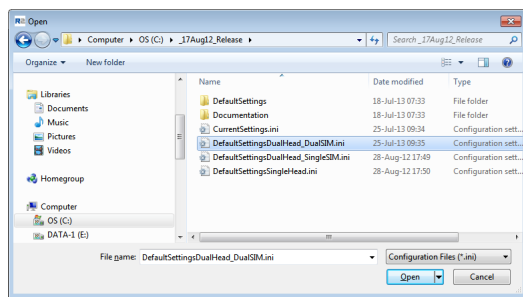
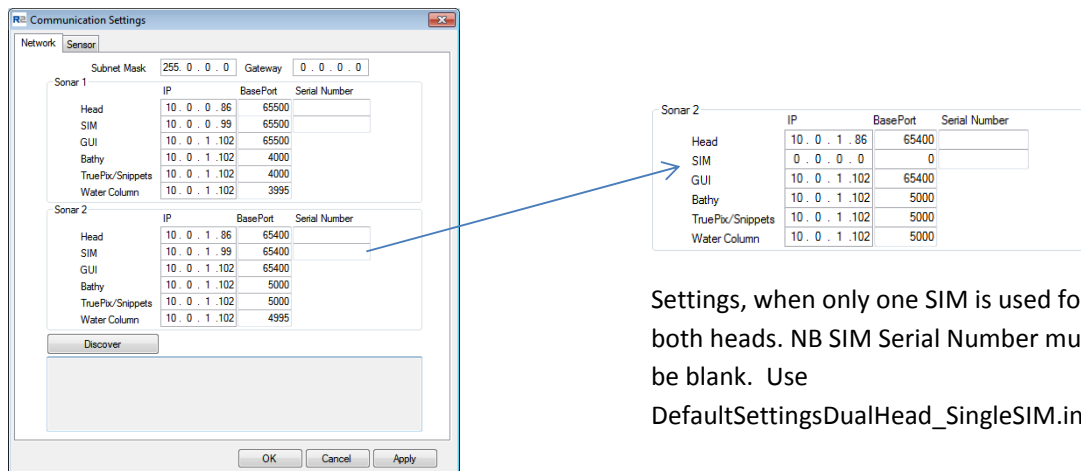

Figure 182: Default .ini settings file

Go to Settings | Network settings to enter the serial numbers for the dual head system. If only one SIM is used for both sonar heads, in Sonar 2 SIM network settings, set the IP and UDP BasePort to 0.



Settings, when only one SIM is used for both heads. NB SIM Serial Number must be blank. Use DefaultSettingsDualHead_SingleSIM.ini

Figure 183: Dual head IP and UDP defaults

Version	3.3	Rev	r000
Date	13-04-2017		

13.9.2.2 Dual Head – Same Frequency – Alternating ping

To operate the dual sonar heads on the same frequency it is necessary to coordinate the transmit and receive periods so there is no interference. Operating in the ‘Ping-Pong’ mode will halve the ping rate for each head, but the user gains identical acoustic resolution (such as backscatter) for both sonar heads. Please see [Section 5.5.10](#) for head synchronisation settings.

13.9.2.3 Dual Head – Dual Frequency – Simultaneous ping

Offsetting the operating frequencies, of both heads, allows the user to ping both heads simultaneously. The amount of frequency separation depends mostly on the manner in which the sonar heads have been installed and, to a lesser extent, environmental factors. Usually, the maximum separation required is 40 – 80 kHz and can be less.

Sonic 2024	Sonar 1	Sonar 2
Frequency (kHz)	400	400
Ping Rate Limit (Hz)	<input checked="" type="checkbox"/> 1	
Sector Coverage (Deg)	120	120
Sector Rotate (Deg)	0	0
Min Range Gate (m)	0	0
Bottom Sampling	Equiangular	
Mission Mode	Down, Bathy Normal	
Roll Stabilize	<input checked="" type="checkbox"/>	
Dual Head Mode	Single head	
TruePix Enable	Single head	
Snippets Enable	Simultaneous ping	
Water Column Enable	<input type="checkbox"/>	<input type="checkbox"/>
Intensity Enable	<input type="checkbox"/>	<input type="checkbox"/>

Figure 184: Dual-sonar head ping modes

13.9.2.4 Dual Head with Two SIM Boxes

If two SIM boxes are used, only one is the master or primary (SIM1). SIM1 will be the SIM to take in all of the serial data as well as the PPS; SIM2 only provides power to the second sonar head. SIM2 is connected to SIM1 via an Ethernet cable to one of the RJ45 ports on SIM1. In the figure, below, the bottom SIM is the primary SIM1, which takes in all of the serial data as well as timing data. The upper SIM is the secondary SIM2 that provides power to the sonar head and passes data to the primary SIM.

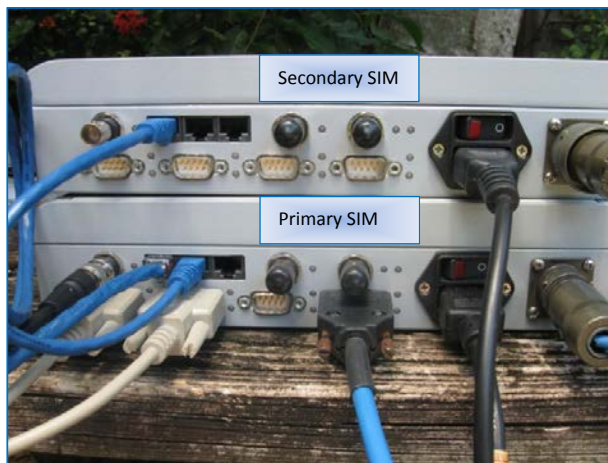

Figure 185: Dual Head - Dual SIM external interfacing

Appendix VIII Sonic Control Commands

14 APPENDIX VIII: R2Sonic Control Commands

14.1 Introduction

This describes the commands sent from the user interface to the sonar head and SIM.

Future versions of firmware will adhere to this format and may include additional commands.

Older versions of head and SIM firmware (prior to Head firmware version 14-Mar-2011 and SIM firmware version 08-Apr-2010) are **not** compatible with this format.

14.2 General Notes

1. These formats are designed for easy 4-byte alignment. Be sure your compiler/linker doesn't insert any extra padding between values. If necessary, use your compiler's "packed" directive.
2. All values have big-endian byte order. Your compiler may provide conversion functions such as htonl, htons, ntohl, ntohs, however those assume integers so you'll need to be very careful with floats.
3. u32 means unsigned integer, 32 bits.
f32 means IEEE-754 32-bit floating point.
4. All packets are UDP/IP datagrams.
5. It's recommended that all commands be sent periodically, at a 1 to 0.5 Hz rate. This ensures that the sonar head and SIM always have the proper settings should a power interruption occur.

14.2.1 Ethernet Port Numbers

```
Head & SIM status & command port = Baseport +2
GUI command port                 = 53810 (fixed port number)
GUI remote command input port    = gui baseport + 7
```

14.2.2 Type Definitions

```
typedef unsigned int  u32;
typedef float         f32;
```

14.2.3 Command Packet Format

Pseudo C format for commands:

```
// *** BEGIN PACKET: COMMAND FORMAT 0 ***
u32  PacketName;           // 'CMD0'

// Command (for network efficiency, the packet can contain multiple commands,
// but ensure the IP datagram reaches the sonar unfragmented).

u32  CommandName;         // example 'RNG0' to set range
x32  CommandValue;       // a 4-byte value such as u32 or f32

// *** END PACKET: COMMAND FORMAT 0 ***
```

Version	3.3	Rev	r000
Date	13-04-2017		

14.3 Head Commands, Binary Format

Cmd	Format	Units	Values	Description
ABS0 ABS1 ABS2 ABS3 ABS4	f32	dB/km	0 to 200	Absorption ABS1-ABS4 are used for MultiMode selections
AIB0	f32	dB	0 to 60	Acoustic image brightness
AIH0	u32	lines	0 = off wedge radius in pixels	Acoustic imagery height. Set to display wedge radius in pixels. Head will return requested lines or less, usually less. Larger values will increase Ethernet data rate.
AUT0	u32		Flag bits 0x00000001 = auto power on 0x00000100 = auto gain on 0x00010000 = auto range on	[7:0] auto power (not functional) [15:8] auto gain (not functional) [23:16] auto range [31:24] spare Auto power/gain work in tandem, thus both are enabled/disabled at same time.
BIE0	u32		0 = off 1 = on	Bathy intensity enable
BMAX	f32	metres	0 to 999	Max range filter Head default = 999 Deprecated 12 Dec 2011, see RGB0
BMIN	f32	metres	0 to 500	Min range filter Head default = 0 Deprecated 12 Dec 2011, see RGA0
BOS0	u32		0 = Equiangle 1 = Equidistant	Bottom sampling
DGA0	f32	metres	0 to 1200	depth gate min
DGB0	f32	metres	0 to 1200	depth gate max
DG00	u32		0x00000000 = gates off 0x00000001 = manual gates 0x0000ww02 = auto gates 0x0000ww03 = auto gate/slope where ww = gate width in ± percent of depth (5% to 90%)	Depth gates control. Manual gates mode require DGA0, DGB0, DGS0 to be set. In auto gates mode, a peak percentage value for gate width must be supplied in bits [15:8] in this command.
DGS0	f32	radians	-π/2 to +π/2	depth gate slope
DHM0	u32		0 = single head 1 = master simultaneous, dual 2 = master alternating, dual 3 = slave simultaneous, dual 4 = slave alternating, dual	Head sync mode (single and dual head modes)
DYNA	u32		0xaaabbbccc aa = spare bbb = slope control ccc = depth control ex: 0x003d0523 shows a bottom at 5m depth which wobbles.	Generates a moving simulated bottom for testing auto gate features. Three control bits: [0:0] = magnitude (0-f) [1:1] = Δ magnitude (0-f) [2:2] = rate of change (0-f) *DYNA is also supported as an ASCII command (enter hex digits without the '0x')
FILT	u32		0 = off 1 = range 2 = depth 3 = range & depth	FILT is deprecated. Do not use (10 Mar 2011). Use DG00, RGA0, RGB0.
FIL0	U32		0 = single 1 = double 2 = quad	Bottom fill enhancement (High Density Mode)

Cmd	Format	Units	Values	Description
FRQ0 FRQ1 FRQ2 FRQ3 FRQ4	f32	Hz	200000 to 400000 and 700000 for UHR	Frequency FRQ1 – FRQ4 are used for MultiMode selections.
GAN0 GAN1 GAN2 GAN3 GAN4	f32		1 to 45	Rcvr gain. gain in dB = setting * 2 GAN1 – GAN4 are used for MultiMode selections
IDC0	U32		1 = Bathy+FLS proj. (model 1004) 2 = UHR proj. (model 1006)	Projector ID override, use for emergency
PNG0	u32		1 = emit one ping only	Manual ping. Each time this command is sent, sonar will emit one ping.
PRL0	f32	Hz	0.1 to 60	Ping rate limit user-value
PRO0	u32		0 = projector forward 1 = projector aft	Projector orientation
PROJ	u32		0 = none 1 = narrow (1°) 2 = wide (20°) (only in FLS mode)	Projector type selector
PRU0	u32		0 = off 1 = on	Ping rate limit user-enable
PRZ0	f32	metres	-1.0 to +1.0	Projector mounting Z offset Default = 0.119
PTS0	U32		0 = off 1 = on	Pitch Stabilization
RET0	f32	radians	-45° to +45°	Receiver tilt
RGA0	f32	metres	0 to 500	Min range filter, was BMIN Head default = 0
RGB0	f32	metres	0 to 999	Min range filter, was BMAX Head default = 999
RG00	u32		0 = range gates off 1 = range gates on	Range gate enable
RNG0	f32	metres	2 to 1200	Range
ROS0	u32		0 = off 1 = on	Roll stabilization enable
SER0 SER1 SER2 SER3 SER4	f32	radians	-55° to +55°	Sector rotate. Wedge edges must not go beyond ±65°.SER1 to SER4 are used for MultiMode selections
SEW0 SEW1 SEW2 SEW3 SEW4	f32	radians	10° to 130°	Sector width SEW1 to SEW4 are used for MultiMode selections
SNIP	u32		0 = off 1 = on	Snippets enable
SPR0 SPR1 SPR2 SPR3 SPR4	f32		0 to 60 typically 20	Spreading loss SPR1 – SPR4 are used for MultiMode selections
STM0	U32		0 = off 1 = on	Status display
SVL0	f32	m/s	1250 to 1600	Sound velocity user-value

Version	3.3	Rev	r000
Date	13-04-2017		

Cmd	Format	Units	Values	Description
SVU0	u32		0 = use SVP 1 = user value	Sound velocity user-enable
TPG0	u32		0 = disable TruePix gates 1 = use bathy gate max 2 = use bathy gates min & max	TruePix gates
TPM0	u32		0 = off 1 = mag only 2 = mag & angle	TruePix mode.
TRG0	u32		0 = free running 1 = external trigger, SIM sync in 2 = standby, wait for PNG0 cmd.	Ping trigger source. Required, SIM command SY10.
TWIX	u32		0 = flat bottom 1 = vertical features	Bottom type
TXF0	f32	metres	0 = infinity (no focusing) -1 = set focus to nadir depth -2 = set focus to halfway between depth gates n =	Projector focus
TXL0	f32	seconds	0 to 1115µs	Pulse length
TXP0	f32	dB/1µPa	0, 177 to 207	Transmitter power
TXW0	u32		0 = rectangular weighting 1 = Kaiser weighting (≈ -2.3 dB SL) 0x/n0 = number of tx staves where n=number of staves (1 to f	Along-track apodizing and size of transmit array. 0xn0 command only works on the Sonic 2020
WCM0	u32		0 = off 1 = mag only 2 = mag & phase	Water column data. warning, high speed data, up to 70MB/s.

Changes:

12 Dec 2011

Added: AIB0, AIH0, SYNC, TRG0, PNG0, RGA0, RGB0, RGO0, STM0
 Deprecated: BMIN, BMAX
 Removed: FILT, MIM0

09 Mar 2012 added TPM0, TPG0

08 Aug 2012 corrected fixed port number in section 3, added IDC0 command

23 Dec 2012 added /instance=n command line switch to gui for multiple gui instances.

05 Feb 2013 added FIL0

25 Mar 2015 added PTS0, TXF0, TXW0

10 Jul 2015 added number of staves control to TXW0.

27 Oct 2015 added TXS0. FRQ0 range changed.

07 Apr 2017 added ABS1-4, FRQ1-4, GAN1-4, SER1-4, SEW1-4, SPR1-4

Version	3.3	Rev	r000
Date	13-04-2017		

Part No. 96000005

14.4 SIM Commands, Binary Format

Cmd	Format	Units	Values	Description
BDGØ	u32	bps	standard baud rates 300 to 115200	GPS baud
BDHØ	u32	bps	standard baud rates 300 to 115200	Heading baud
BDMØ	u32	bps	standard baud rates 300 to 115200	Motion baud
BDSØ	u32	bps	standard baud rates 300 to 115200	SVP baud
DBGØ	u32		7 or 8	GPS data bits
DBHØ	u32		7 or 8	Heading data bits
DBMØ	u32		7 or 8	Motion data bits
DBSØ	u32		7 or 8	SVP data bits
DRGØ	u32		0 = RS-232 1 = Ethernet 2 = off	GPS Interface
DRHØ	u32		0 = RS-232 1 = Ethernet 2 = off	Heading Interface(not implemented)
DRMØ	u32		0 = RS-232 1 = Ethernet 2 = off	Motion Interface
DRSØ	u32		0 = RS-232 1 = Ethernet 2 = off	SVP Interface
ENGØ	u32		0 = off 1 = on	GPS enable
ENHØ	u32		0 = off 1 = on	Heading enable Heading data not used
ENMØ	u32		0 = off 1 = on	Motion enable
ENSØ	u32		0 = off 1 = on	SVP enable
IPGØ	u32			GPS IP Address
IPMØ	u32			Motion sensor IP Address
PAGØ	u32		0 = none 1 = odd 2 = even	GPS parity
PAHØ	u32		0 = none 1 = odd 2 = even	Heading parity
PAMØ	u32		0 = none 1 = odd 2 = even	Motion parity
PASØ	u32		0 = none 1 = odd 2 = even	SVP parity
POGØ	u32		0 = rising 1 = falling 2 = sync on time message (no PPS)	PPS edge. Sync on time message will sync to the RS232 message; PPS pulse is not used.
PTGØ	u32		0 TO 65535	GPS Ethernet port number
PTMØ	u32		0 TO 65535	Motion sensor Ethernet port number.

Cmd	Format	Units	Values	Description
SBG0	u32		1,2	GPS stop bits
SBH0	u32		1,2	Heading stop bits
SBM0	u32		1.2	Motion stop bits
SBS0	u32		1,2	SVP stop bits
SPO0	u32		0 = head power off 1 = head power on	Sonar head power
STM0	u32		0 = off 1 = on, normal mode	Status data
SYI0	u32		0 = off 1 = rising edge trigger 2 = falling edge trigger	Trigger in mode. Middle of transmit pulse is offset by +10ms from trigger edge. Required, Head TRG) command
SYO0	u32		0 = rises at center of tx pulse, falls at end of rcv pulse, rises at end of rcv pulse, rises at end of rcv pulse, rises at end of rcv pulse 1 = falls at center of tx pulse, rises at end of rcv pulse, rises at end of rcv pulse, rises at end of rcv pulse 2 = off	Trigger out mode

Changes:

12 Dec 2011

Added: SYI0, SYO0, STM0

31 Oct 2013

Changed DRG0, DRH0, DRM0, DRS0, POM0 to PTM0

Added IPG0, IPS0, PTG0, PTS0

07 Apr 2014

Amended DRG0, DRH0, DRM0, DRS0 ('off' value was omitted)

Update DGA0, DGB0, RNG0 values changed from 2-500 to 2-1200

Version	3.3	Rev	r000
Date	13-04-2017		

Part No. 96000005

14.5 GUI Commands, Binary Format

These commands are provided to control various GUI functions remotely. Commands are sent to GUI Baseport + 7

Cmd	Format	Units	Values	Description
ABS0	f32	dB/km	0 to 200	Absorption
DGA0	f32	metres	0 to 1200	Depth gate minimum
DGB0	f32	metres	0 to 1200	Depth gate maximum
DGS0	f32	degrees	-90° to +90°	Depth gate slope
GAN0	f32		1 to 45	Rcvr gain. Gain in dB = setting * 2
PNG0	u32		1 = emit one ping only	Manual ping. Each time this command is sent, sonar emit one ping. See TRG0 command
RNG0	f32	metres	2 to 1200	Range
SER0	f32	degrees	-55° to +55°	Sector rotate. Wedge edges must not go beyond ±65° (for Sonic 2020)
SEW0	f32	radians	10° to 130°	Sector width (for Sonic 2020)
SPR0	f32		0 to 60 typically 20	Spreading loss
TXL0	f32	seconds	0 to 1115µs for 2020, 2022 and 2024 0,140µs to 2000µs for 2026	Transmitter pulse length
TXP0	f32	dB/1µPa	0, 177 to 207	Transmitter power (for Sonic 2020)
WCR0	u32		0 = off 1 = on	Water column enable, head 1. Equivalent to setting the water column check box in the GUI
WCR1	u32			Water column enable, head 2. Equivalent to setting the water column check box in the GUI

Note the commands which set angle values are in degrees. This is different from angular commands sent to the head which are in radians.

Changes:

09 March 2012: added GUI commands (this section)

31 Oct 2013: added ABS0 and SPR0

10 Jul 2015 added TXL0

14.5.1 GUI Command Line Switches

`/custffmpeg` Allows user to define video recording commands for ffmpeg. The command line options are in the CurrentSettings.ini file. Use at your own risk as ffmpeg is a difficult program to comprehend.

`/instance=n` Multiple gui instances, where **n** is the gui instance. **n** = 1 to 9. Need CurrentSettingsn.ini file.

`/sector160` Sector coverage override for 2020. Normally, 2020 sector coverage is 130°. This switch allows 2020 sector coverage to 160°.

NB. The commands which set angle values are in degrees. This is different from angular commands sent to the head, which are in radians.

Version	3.3	Rev	r000
Date	13-04-2017		

14.6 Command Examples Sent to the Sonar Head and SIM

Example of commands sent to the sonar head every two seconds. Columns after the command are hex, integer, and floating point representations of the data sent for each command

PacketName: CMD0			
Command: ABS0	0x42a00000	1117782016	80.000000
Command: SPR0	0x41f00000	1106247680	30.000000
Command: SVL0	0x44bb8000	1153138688	1500.000000
Command: SVU0	0x00000000	0	0.000000
Command: RGO0	0x00000000	0	0.000000
Command: AUT0	0x00000000	0	0.000000
Command: RNG0	0x41a00000	1101004800	20.000000
Command: GAN0	0x41500000	1095761920	13.000000
Command: FRQ0	0x48c35000	1220759552	400000.000000
Command: TXP0	0x433f0000	1128202240	191.000000
Command: TXL0	0x37a7c5ac	933741996	0.000020
Command: SEW0	0x40060a92	1074137746	2.094395
Command: DGA0	0x40a8f312	1084814098	5.279672
Command: DGB0	0x410cca8f	1091357327	8.799453
Command: DGS0	0x00000000	0	0.000000
Command: DGO0	0x00000001	1	0.000000
Command: PRL0	0x3f800000	1065353216	1.000000
Command: PRU0	0x00000000	0	0.000000
Command: RET0	0x00000000	0	0.000000
Command: PRO0	0x00000000	0	0.000000
Command: PRZ0	0x3df3b646	1039382086	0.119000
Command: SER0	0x00000000	0	0.000000
Command: B0S0	0x00000000	0	0.000000
Command: TWIX	0x00000000	0	0.000000
Command: PROJ	0x00000001	1	0.000000
Command: ROS0	0x00000001	1	0.000000
Command: DHM0	0x00000000	0	0.000000
Command: SNIP	0x00000000	0	0.000000
Command: BIE0	0x00000000	0	0.000000
Command: AIH0	0x00000000	0	0.000000
Command: AIB0	0x40c00000	1086324736	6.000000
Command: WCM0	0x00000000	0	0.000000
Command: TPM0	0x00000000	0	0.000000
Command: TPG0	0x00000000	0	0.000000
Command: TRG0	0x00000000	0	0.000000
Command: STM0	0x00000002	2	0.000000

Example of commands sent to the SIM every two seconds. Columns after the command are hex, integer, and floating point representations of the data sent for each command

PacketName: CMD0			
Command: ENG0	0x00000001	1	0.000000
Command: BDG0	0x00002580	9600	0.000000
Command: DBG0	0x00000008	8	0.000000
Command: DRG0	0x00000000	0	0.000000
Command: PAG0	0x00000000	0	0.000000
Command: SBG0	0x00000001	1	0.000000
Command: POG0	0x00000001	1	0.000000
Command: SYI0	0x00000000	0	0.000000
Command: SYO0	0x00000000	0	0.000000
Command: ENH0	0x00000001	1	0.000000
Command: BDH0	0x00002580	9600	0.000000
Command: DBH0	0x00000008	8	0.000000
Command: DRH0	0x00000000	0	0.000000
Command: PAH0	0x00000000	0	0.000000
Command: SBH0	0x00000001	1	0.000000
Command: ENM0	0x00000001	1	0.000000
Command: IPM0	0x0a00002f	167772207	0.000000
Command: POM0	0x00001388	5000	0.000000
Command: BDM0	0x00009600	38400	0.000000
Command: DBM0	0x00000008	8	0.000000
Command: DRM0	0x00000000	0	0.000000
Command: PAM0	0x00000000	0	0.000000
Command: SBM0	0x00000001	1	0.000000
Command: ENS0	0x00000001	1	0.000000
Command: BDS0	0x00002580	9600	0.000000
Command: DBS0	0x00000008	8	0.000000
Command: DRS0	0x00000000	0	0.000000
Command: PAS0	0x00000000	0	0.000000
Command: SBS0	0x00000001	1	0.000000
Command: SPO0	0x00000001	1	0.000000
Command: STM0	0x00000002	2	0.000000

Example of UDP/IP Ethernet packet of commands sent to the sonar head.

First 42 characters are Ethernet header information. Characters after 29h are commands

0000	00 50 c2 90 44 a3 00 1b 21 40 04 84 08 00 45 00	.P..D...!@....E.
0010	01 48 09 8b 40 00 80 11 00 00 0a 00 01 66 0a 00	.H..@.....f..
0020	00 56 f6 31 ff de 01 34 17 01 43 4d 44 30 41 42	.V.1...4..CMD0AB
0030	53 30 42 a0 00 00 53 50 52 30 41 a0 00 00 53 56	S0B...SPR0A...SV
0040	4c 30 44 bb 00 00 53 56 55 30 00 00 00 01 52 47	L0D...SVU0...RG
0050	4f 30 00 00 00 00 41 55 54 30 00 00 00 00 52 4e	00...AUT0...RN
0060	47 30 41 c8 00 00 47 41 4e 30 41 60 00 00 46 52	G0A...GAN0A`..FR
0070	51 30 48 43 50 00 54 58 50 30 43 3f 00 00 54 58	Q0HCP.TXP0C?..TX
0080	4c 30 37 d1 b7 17 53 45 57 30 40 06 0a 92 44 47	L07...SEW0@...DG
0090	41 30 40 d9 99 9a 44 47 42 30 41 26 66 66 44 47	A0@...DGB0A&fFDG
00a0	53 30 00 00 00 00 44 47 4f 30 00 00 00 01 50 52	S0...DGO0...PR
00b0	4c 30 3f 80 00 00 50 52 55 30 00 00 00 00 52 45	L0?...PRU0...RE
00c0	54 30 00 00 00 00 50 52 4f 30 00 00 00 00 50 52	T0...PRO0...PR
00d0	5a 30 3d f3 b6 46 53 45 52 30 00 00 00 00 42 4f	Z0=..FSER0...BO
00e0	53 30 00 00 00 00 46 49 4c 30 00 00 00 00 54 57	S0...FIL0...TW
00f0	49 58 00 00 00 00 50 52 4f 4a 00 00 00 01 52 4f	IX...PROJ...RO
0100	53 30 00 00 00 00 50 54 53 30 00 00 00 00 44 48	S0...PTS0...DH
0110	4d 30 00 00 00 00 53 4e 49 50 00 00 00 00 41 49	M0...SNIP...AI
0120	48 30 00 00 01 18 41 49 42 30 41 f0 00 00 57 43	H0...AIB0A...WC
0130	4d 30 00 00 00 00 42 49 45 30 00 00 00 01 54 50	M0...BIE0...TP
0140	4d 30 00 00 00 01 54 50 47 30 00 00 00 00 53 54	M0...TPG0...ST
0150	4d 30 00 00 00 02	M0....

Example of UDP/IP Ethernet packet of commands sent to the SIM.

First 42 characters are Ethernet header information. Characters after 29h are commands.

0000	00 50 c2 90 41 26 00 1b 21 40 04 84 08 00 45 00	.P..A&..!@....E.
0010	01 18 0c 0e 40 00 80 11 00 00 0a 00 01 66 0a 00	...@.....f..
0020	00 63 d6 ad ff de 01 04 16 de 43 4d 44 30 45 4e	.c.....CMD0EN
0030	47 30 00 00 00 01 44 52 47 30 00 00 00 01 49 50	G0...DRG0...IP
0040	47 30 00 00 00 00 50 54 47 30 00 00 15 e6 42 44	G0...PTG0...BD
0050	47 30 00 00 25 80 44 42 47 30 00 00 00 08 50 41	G0...%DBG0...PA
0060	47 30 00 00 00 00 53 42 47 30 00 00 00 01 50 4f	G0...SBG0...PO
0070	47 30 00 00 00 00 53 59 49 30 00 00 00 00 53 59	G0...SYI0...SY
0080	4f 30 00 00 00 00 45 4e 48 30 00 00 00 00 44 52	00...ENH0...DR
0090	48 30 00 00 00 02 45 4e 4d 30 00 00 00 01 44 52	H0...ENM0...DR
00a0	4d 30 00 00 00 01 49 50 4d 30 0a 00 00 2d 50 54	M0...IPM0...-PT
00b0	4d 30 00 00 15 e6 42 44 4d 30 00 00 4b 00 44 42	M0...BDM0...K.DB
00c0	4d 30 00 00 00 08 50 41 4d 30 00 00 00 00 53 42	M0...PAM0...SB
00d0	4d 30 00 00 00 01 45 4e 53 30 00 00 00 01 44 52	M0...ENS0...DR
00e0	53 30 00 00 00 00 49 50 53 30 00 00 00 00 50 54	S0...IPS0...PT
00f0	53 30 00 00 00 00 42 44 53 30 00 00 25 80 44 42	S0...BDS0...%.DB
0100	53 30 00 00 00 08 50 41 53 30 00 00 00 00 53 42	S0...PAS0...SB
0110	53 30 00 00 00 01 53 50 4f 30 00 00 00 01 53 54	S0...SPO0...ST
0120	4d 30 00 00 00 02	M0....

Appendix IX: R2Sonic Data Format

15 APPENDIX IX: R2Sonic Uplink Data Formats

15.1 Introduction

This describes the data formats sent from the sonar head and SIM. Unless noted, the data packets are sent from the sonar head. The formats are given in pseudo C.

Head firmware versions 13-Dec-2011, and newer, utilise the data formats in this document.

Previous head firmware versions back to 25-Mar-2010 only utilise data formats from sections 14.5 and 14.6 in this document. Future versions of firmware will adhere to this format and may include additional information.

The data format, in older versions of sonar head firmware, is different than the format described in this document and is unsupported.

15.2 General Notes

1. Each info or data section includes a name/size mini-header to allow the parser to easily skip unneeded or unrecognized sections. These formats are designed for easy 4-byte alignment. Be sure your compiler/linker doesn't insert any extra padding between values. If necessary, use your compiler's "packed" directive.
2. All values have big-endian byte order. Your compiler may provide conversion functions such as htonl, htons, ntohl, ntohs, however those assume integers so you'll need to be very careful with floats.
3. u8, u16, u32 means unsigned integers of 8, 16, 32 bits.
s8, s16, s32 means signed integers of 8, 16, 32 bits.
f32 means IEEE-754 32-bit floating point.
4. All packets are UDP/IP datagrams

15.3 Port Numbers

Bathymetry data port = gui.Baseport + 0
 TruePix data port = tpd.Baseport + 1
 Device status port = gui.Baseport + 2
 Acoustic Image data port = gui.Baseport + 3
 Water Column data port = wcd.Baseport + 5
 Snippets data port = tpd.Baseport + 6

15.4 Type Definitions

```
typedef unsigned char u8;
typedef unsigned short u16;
typedef unsigned int u32;
typedef signed char s8;
typedef signed short s16;
typedef signed int s32;
typedef float f32;
```

Version	3.3	Rev	r000
Date	13-04-2017		

15.5 Ethernet Data Rates

Bathymetry: ≈ 800 kb/s max (bathy data is sent twice, to GUI and data acquisition computer)

TruePix: ≈ 5.5 Mb/s (magnitude + angle) max

≈ 3.5 Mb/s (magnitude) max

Water Column: ≈ 560 Mb/s (magnitude + phase) max

≈ 280 Mb/s (magnitude) max

Snippets: ≈ 11 Mb/s max

Where Mb/s = megabits per second.

Version	3.3	Rev	r000
Date	13-04-2017		

15.6 Bathymetry Packet Format

```
// *** BEGIN PACKET: BATHY DATA FORMAT 0 ***

u32 PacketName;           // 'BTH0'
u32 PacketSize;          // [bytes] size of this entire packet
u32 DataStreamID;        // reserved for future use

// section H0: header

u16 H0_SectionName;      // 'H0'
u16 H0_SectionSize;      // [bytes] size of this entire section
u8 H0_ModelNumber[12];   // example "2024", unused chars are nulls
u8 H0_SerialNumber[12];  // example "100017", unused chars are nulls
u32 H0_TimeSeconds;      // [seconds] ping time relative to 0000 hours 1-Jan-1970, integer part
u32 H0_TimeNanoseconds;  // [nanoseconds] ping time relative to 0000 hours 1-Jan-1970, fraction part
u32 H0_PingNumber;       // pings since power-up or reboot
f32 H0_PingPeriod;       // [seconds] time between most recent two pings
f32 H0_SoundSpeed;      // [meters per second]
f32 H0_Frequency;       // [hertz] sonar center frequency
f32 H0_TxPower;          // [dB re 1 uPa at 1 meter]
f32 H0_TxPulseWidth;    // [seconds]
f32 H0_TxBeamwidthVert; // [radians]
f32 H0_TxBeamwidthHoriz; // [radians]
f32 H0_TxSteeringVert;  // [radians]
f32 H0_TxSteeringHoriz; // [radians]
u16 H0_2026ProjTemp;    // [hundredths of a degree Kelvin] 2026 projector temperature (divide value by 100, subtract 273.15 to get °C)
s16 H0_VTX+Offset;      // [hundredths of a dB] transmit voltage offset at time of ping (divide value by 100 to get dB)
f32 H0_RxBandwidth;     // [hertz]
f32 H0_RxSampleRate;    // [hertz] sample rate of data acquisition and signal processing
f32 H0_RxRange;         // [meters] sonar range setting
f32 H0_RxGain;          // [multiply by two for relative dB]
f32 H0_RxSpreading;     // [dB (times log range in meters)]
f32 H0_RxAbsorption;    // [dB per kilometer]
f32 H0_RxMountTilt;     // [radians]
u32 H0_RxMiscInfo;      // reserved for future use
u16 H0_reserved;        // reserved for future use
u16 H0_Points;          // number of bathy points
```

Version	3.3	REV	r000
Date	13-04-2017		

```

// section R0: 16-bit bathy point ranges

u16 R0_SectionName;           // 'R0'
u16 R0_SectionSize;          // [bytes] size of this entire section
f32 R0_ScalingFactor;
u16 R0_Range[H0_Points];     // [seconds two-way] = R0_Range * R0_ScalingFactor
u16 R0_unused[H0_Points & 1]; // ensure 32-bit section size

// section A0: bathy point angles, equally-spaced (present only during "equi-angle" spacing mode)

u16 A0_SectionName;           // 'A0'
u16 A0_SectionSize;          // [bytes] size of this entire section
f32 A0_AngleFirst;           // [radians] angle of first (port side) bathy point, relative to array centerline, AngleFirst < AngleLast
f32 A0_AngleLast;            // [radians] angle of last (starboard side) bathy point
f32 A0_MoreInfo[6];          // reserved for future use

// section A2: 16-bit bathy point angles, arbitrarily-spaced (present only during "equi-distant" spacing mode)

u16 A2_SectionName;           // 'A2'
u16 A2_SectionSize;          // [bytes] size of this entire section
f32 A2_AngleFirst;           // [radians] angle of first (port side) bathy point, relative to array centerline, AngleFirst < AngleLast
f32 A2_ScalingFactor;
f32 A2_MoreInfo[6];          // reserved for future use
u16 A2_AngleStep[H0_Points]; // [radians] angle[n] = A2_AngleFirst + (32-bit sum of A2_AngleStep[0] through A2_AngleStep[n]) * A2_ScalingFactor
u16 A2_unused[H0_Points & 1]; // ensure 32-bit section size

// section I1: 16-bit bathy intensity (present only if enabled)

u16 I1_SectionName;           // 'I1'
u16 I1_SectionSize;          // [bytes] size of this entire section
f32 I1_ScalingFactor;
u16 I1_Intensity[H0_Points]; // [micropascals] intensity[n] = I1_Intensity[n] * I1_ScalingFactor
u16 I1_unused[H0_Points & 1]; // ensure 32-bit section size

// section G0: simple straight-line depth gates

u16 G0_SectionName;           // 'G0'
u16 G0_SectionSize;          // [bytes] size of this entire section
f32 G0_DepthGateMin;         // [seconds two-way]
f32 G0_DepthGateMax;         // [seconds two-way]
f32 G0_DepthGateSlope;       // [radians]

```

Version	3.3	Rev	r000
Date	13-04-2017		

```
// section G1: 8-bit gate positions, arbitrary paths (present only during "verbose" gate description mode)

u16 G1_SectionName;          // 'G1'
u16 G1_SectionSize;          // [bytes] size of this entire section
f32 G1_ScalingFactor;
struct
{
    u8  RangeMin;              // [seconds two-way] = RangeMin * G1_ScalingFactor
    u8  RangeMax;              // [seconds two-way] = RangeMax * G1_ScalingFactor
} G1_Gate[H0_Points];
u16 G1_unused[H0_Points & 1]; // ensure 32-bit section size

// section Q0: 4-bit quality flags

u16 Q0_SectionName;          // 'Q0' quality, 4-bit
u16 Q0_SectionSize;          // [bytes] size of this entire section
u32 Q0_Quality[(H0_Points+7)/8]; // 8 groups of 4 flags bits (phase detect, magnitude detect, reserved, reserved), packed left-to-right

// *** END PACKET: BATHY FORMAT 0 ***
```

Version	3.3	Rev	r000
Date	13-04-2017		

15.7 Snippet Format

```
// *** BEGIN PACKET: SNIPPET DATA FORMAT 0 ***

u32 PacketName;           // 'SNI0'
u32 PacketSize;          // may be zero in UDP, otherwise: [bytes] size of this entire packet
u32 DataStreamID;        // reserved for future use

// section H0: header (present only in first snippet packet of each ping)

  u16 H0_SectionName;     // 'H0'
u16 H0_SectionSize;      // [bytes] size of this entire section
u8 H0_ModelNumber[12];   // example "2024", unused chars are nulls
u8 H0_SerialNumber[12];  // example "100017", unused chars are nulls
u32 H0_TimeSeconds;      // [seconds] ping time relative to 0000 hours 1-Jan-1970, integer part
u32 H0_TimeNanoseconds; // [nanoseconds] ping time relative to 0000 hours 1-Jan-1970, fraction part
u32 H0_PingNumber;       // pings since power-up or reboot
f32 H0_PingPeriod;       // [seconds] time between most recent two pings
f32 H0_SoundSpeed;       // [meters per second]
f32 H0_Frequency;        // [hertz] sonar center frequency
f32 H0_TxPower;          // [dB re 1 uPa at 1 meter]
f32 H0_TxPulseWidth;     // [seconds]
f32 H0_TxBeamwidthVert;  // [radians]
f32 H0_TxBeamwidthHoriz; // [radians]
f32 H0_TxSteeringVert;   // [radians]
f32 H0_TxSteeringHoriz;  // [radians]
u16 H0_2026ProjTemp;     // [hundredths of a degree Kelvin] 2026 projector temperature (divide value by 100, subtract 273.15 to get °C)
s16 H0_VTX+Offset;       // [hundredths of a dB] transmit voltage offset at time of ping (divide value by 100 to get dB)
f32 H0_RxBandwidth;      // [hertz]
f32 H0_RxSampleRate;     // [hertz] sample rate of data acquisition and signal processing
f32 H0_RxRange;          // [meters] sonar range setting
f32 H0_RxGain;           // [multiply by two for relative dB]
f32 H0_RxSpreading;      // [dB (times log range in meters)]
f32 H0_RxAbsorption;     // [dB per kilometer]
f32 H0_RxMountTilt;      // [radians]
u32 H0_RxMiscInfo;       // reserved for future use
u16 H0_reserved;         // reserved for future use
u16 H0_Snippets;         // number of snippets
f32 H0_MoreInfo[6];      // reserved for future use
```

Version	3.3	Rev	r000
Date	13-04-2017		

```

// section S1: 16-bit snippet data (for network efficiency packet may contain several of these sections) (supports snippets up to 32K samples
by fragmenting
// at the IP level rather than by the application like 81xx)

u16 S1_SectionName;           // 'S1'
u16 S1_SectionSize;          // [bytes] size of this entire section
u32 S1_PingNumber;           // pings since power-up or reboot
u16 S1_SnippetNumber;        // snippet number, 0 to H0_Snippets-1
u16 S1_Samples;              // number of samples in this snippet, sample rate is H0_RxSampleRate
u32 S1_FirstSample;          // first sample of this snippet relative to zero range, sample rate is H0_RxSampleRate
f32 S1_Angle;                // [radians] angle of this snippet, relative to array centerline
f32 S1_ScalingFactorFirst;   // scaling factor at start of snippet, 0=ignore, use linear interpolation to get other values
f32 S1_ScalingFactorLast;    // scaling factor at end of snippet, 0=ignore
u32 S1_reserved;             // reserved for future use
u16 S1_Magnitude[S1_Samples]; // [micropascals] = S1_Magnitude[n] * (linear interpolate between S1_ScalingFactorFirst and S1_ScalingFactorLast)
u16 S1_unused[S1_Samples & 1]; // ensure 32-bit section size

// *** END PACKET: SNIPPET DATA FORMAT 0 ***

```

Version	3.3	Rev	r000
Date	13-04-2017		

15.8 Water Column (WC) Data Format

```
// *** BEGIN PACKET: WATER COLUMN (WC) DATA FORMAT 0 ***

// The water column data contains real-time beamformer 16-bit magnitude data
// (beam amplitude) and optional 16-bit split-array phase data (intra-beam
// direction). Maximum data rate is about 70 megabytes per second (assuming
// 256 beams, 68.4 kHz sample rate, and phase data enabled). The sample rate
// (and signal bandwidth) varies with transmit pulse width and range setting.
// Maximum ping data size is about 32 megabytes (assuming 256 beams of 32768
// samples, and phase data enabled), but max size may change in the future.
// The number of beamformed data samples normally extends somewhat further
// than the user's range setting.
//
// When the operator enables water column mode, each sonar ping outputs
// numerous 'WCD0' packets containing: one H0 header section, one A1 beam
// angle section, and many M1 or M2 data sections. The section order may
// change in the future, so plan for that in your data acquisition.
//
// Each M1 or M2 section contains a subset of the ping data. Its header
// indicates its size position to help you assemble the full ping array.
//
// You may wish to detect missing M1 or M2 data sections (perhaps a lost
// UDP packet), and then fill the gap with zeros or perhaps data from the
// previous ping (to reduce visual disturbances), and then increment an
// error counter for network health monitoring purposes.
//
// The water column data is basically in polar coordinates, so you may
// wish to geometrically warp it into the familiar wedge shape for display.
// Consider using OpenGL or Direct3D texture mapping.

u32 PacketName;           // 'WCD0'
u32 PacketSize;          // [bytes] size of this entire packet
u32 DataStreamID;        // reserved for future use
```

Version	3.3	Rev	r000
Date	13-04-2017		

```
// section H0: header (only one per ping)

u16 H0_SectionName;           // 'H0'
u16 H0_SectionSize;          // [bytes] size of this entire section
u8  H0_ModelNumber[12];      // example "2024", unused chars are nulls
u8  H0_SerialNumber[12];     // example "100017", unused chars are nulls
u32 H0_TimeSeconds;          // [seconds] ping time relative to 0000 hours 1-Jan-1970, integer part
u32 H0_TimeNanoseconds;     // [nanoseconds] ping time relative to 0000 hours 1-Jan-1970, fraction part
u32 H0_PingNumber;           // pings since power-up or reboot
f32 H0_PingPeriod;           // [seconds] time between most recent two pings
f32 H0_SoundSpeed;           // [meters per second]
f32 H0_Frequency;            // [hertz] sonar center frequency
f32 H0_TxPower;              // [dB re 1 uPa at 1 meter]
f32 H0_TxPulseWidth;         // [seconds]
f32 H0_TxBeamwidthVert;      // [radians]
f32 H0_TxBeamwidthHoriz;     // [radians]
f32 H0_TxSteeringVert;       // [radians]
f32 H0_TxSteeringHoriz;     // [radians]
u16 H0_TxMiscInfo;           // reserved for future use
s16 H0_VTX+Offset;           // [hundredths of a dB] transmit voltage offset at time of ping (divide value by 100 to get dB)
f32 H0_RxBandwidth;          // [hertz]
f32 H0_RxSampleRate;         // [hertz] sample rate of data acquisition and signal processing
f32 H0_RxRange;              // [meters] sonar range setting
f32 H0_RxGain;               // [multiply by two for relative dB]
f32 H0_RxSpreading;          // [dB (times log range in meters)]
f32 H0_RxAbsorption;         // [dB per kilometer]
f32 H0_RxMountTilt;          // [radians]
u32 H0_RxMiscInfo;           // reserved for future use
u16 H0_reserved;             // reserved for future use
u16 H0_Beams;                 // number of beams

// section A1: float beam angles, arbitrarily-spaced (only one per ping)

u16 A1_SectionName;          // 'A1'
u16 A1_SectionSize;          // [bytes] size of this entire section
f32 A1_MoreInfo[6];          // reserved for future use
f32 A1_BeamAngle[H0_Beams];  // [radians] angle of beam relative to array centerline, ordered from port to starboard, first angle < last angle

// section M1: 16-bit magnitude data (present only during "magnitude-only" water column data mode, many per ping, you assemble them into
// complete ping data)

u16 M1_SectionName;          // 'M1'
u16 M1_SectionSize;          // [bytes] size of this entire section
u32 M1_PingNumber;           // pings since power-up or reboot
f32 M1_ScalingFactor;        // reserved for future use
u32 M1_TotalSamples;         // range samples in entire ping, sample rate is H0_RxSampleRate
u32 M1_FirstSample;          // first sample of this section
u16 M1_Samples;              // number of samples in this section
u16 M1_TotalBeams;           // beams (always a multiple of 2) (typically columns in your memory buffer)
u16 M1_FirstBeam;            // first beam of this section (always a multiple of 2)
u16 M1_Beams;                // number of beams in this section (always a multiple of 2)
```

Version	3.3	Rev	r000
Date	13-04-2017		

```

u32 M1_reserved0;           // reserved for future use
u32 M1_reserved1;         // reserved for future use
struct

{
    u16 magnitude;         // values 0 to 65535 map non-linearly (due to TVG scaling and possible gain compression) to signal amplitude
} M1_Data[M1_Beams][M1_Samples]; // magnitude data (typical example: 256 beams each containing 36 two-byte structs, 16 kilobytes)

// section M2: 16-bit magnitude and phase data (present only during "magnitude and phase" water column data mode, many per ping, you assemble
them into
// complete ping data)

u16 M2_SectionName;       // 'M2'
u16 M2_SectionSize;       // [bytes] size of this entire section
u32 M2_PingNumber;        // pings since power-up or reboot
f32 M2_ScalingFactor;     // reserved for future use
u32 M2_TotalSamples;     // range samples in entire ping, sample rate is H0_RxSampleRate
u32 M2_FirstSample;      // first sample of this section
u16 M2_Samples;          // number of samples in this section
u16 M2_TotalBeams;       // beams (always a multiple of 2) (typically columns in your memory buffer)
u16 M2_FirstBeam;        // first beam of this section (always a multiple of 2)
u16 M2_Beams;            // number of beams in this section (always a multiple of 2)
u32 M2_reserved0;       // reserved for future use
u32 M2_reserved1;       // reserved for future use
struct
{
    u16 magnitude;        // values 0 to 65535 map non-linearly (due to TVG scaling and possible gain compression) to signal amplitude
    s16 phase;            // values -32768 to +32767 map non-linearly (due to complex transfer function) to target angle within the beamwidth
} M2_Data[M2_Beams][M2_Samples]; // magnitude and phase data (typical example: 256 beams each containing 36 four-byte structs, 36 kilobytes)

// *** END PACKET: WATER COLUMN (WC) DATA FORMAT 0 ***

```

Version	3.3	Rev	r000
Date	13-04-2017		

15.9 Acoustic Image (AI) Data Format

```
// *** BEGIN PACKET: ACOUSTIC IMAGE (AI) DATA FORMAT 0 ***
// The acoustic image data contains real-time beamformer 8-bit magnitude data
// (beam amplitude) that has been scaled to 8-bits by a user-selected
// brightness value, and compressed in range by an adjustable amount to
// reduce network bandwidth and processing. The data is called "samples"
// before compression and "bins" after compression. For example, 7200 samples
// of beamformer data (M0_TotalSamples) may be compressed to 600 bins
// (M0_TotalBins). The number of beamformed data samples normally extends
// somewhat further than the user's range setting. The AIH0 sonar command
// sets an upper limit to the number of compressed output bins. It's not a
// precise compression factor, so the number of bins is usually somewhat less
// than the AIH0 value. The maximum data rate with no compression is about
// 17.5 megabytes per second (assuming 256 beams).
//
// When the operator enables acoustic image mode, each sonar ping outputs
// numerous 'AID0' packets containing: one H0 header section, one A1 beam
// angle section, and many M0 data sections. The section order may change in
// the future, so plan for that in your data acquisition.
//
// Each M0 section contains a subset of the ping data. Its header indicates
// its size position to help you assemble the full ping array.
//
// You may wish to detect missing M0 data sections (perhaps a lost UDP
// packet), and then fill the gap with zeros or perhaps data from the
// previous ping (to reduce visual disturbances), and then increment an error
// counter for network health monitoring purposes.
//
// The acoustic image data is basically in polar coordinates, so you may wish
// to geometrically warp it into the familiar wedge shape for display.
// Consider using OpenGL or Direct3D texture mapping.

u32 PacketName;           // 'AID0'
u32 PacketSize;          // [bytes] size of this entire packet
u32 DataStreamID;        // reserved for future use

// section H0: header (only one per ping)

u16 H0_SectionName;      // 'H0'
u16 H0_SectionSize;      // [bytes] size of this entire section
u8  H0_ModelNumber[12];  // example "2024", unused chars are nulls
u8  H0_SerialNumber[12]; // example "100017", unused chars are nulls
u32 H0_TimeSeconds;      // [seconds] ping time relative to 0000 hours 1-Jan-1970, integer part
u32 H0_TimeNanoseconds; // [nanoseconds] ping time relative to 0000 hours 1-Jan-1970, fraction part
u32 H0_PingNumber;       // pings since power-up or reboot
f32 H0_PingPeriod;       // [seconds] time between most recent two pings
f32 H0_SoundSpeed;       // [meters per second]
f32 H0_Frequency;        // [hertz] sonar center frequency
```

Version	3.3	Rev	r000
Date	13-04-2017		

```

f32 H0_TxPower;           // [dB re 1 uPa at 1 meter]
f32 H0_TxPulseWidth;     // [seconds]
f32 H0_TxBeamwidthVert;  // [radians]
f32 H0_TxBeamwidthHoriz; // [radians]
f32 H0_TxSteeringVert;   // [radians]
f32 H0_TxSteeringHoriz;  // [radians]
u16 H0_2026ProjTemp;     // [hundredths of a degree Kelvin] 2026 projector temperature (divide value by 100, subtract 273.15 to get °C)
u16 H0_TxMiscInfo;       // reserved for future use
s16 H0_VTX+Offset;      // [hundredths of a dB] transmit voltage offset at time of ping (divide value by 100 to get dB)
f32 H0_RxBandwidth;      // [hertz]
f32 H0_RxSampleRate;     // [hertz] sample rate of data acquisition and signal processing
f32 H0_RxRange;          // [meters]
f32 H0_RxGain;           // [multiply by two for relative dB]
f32 H0_RxSpreading;      // [dB (times log range in meters)]
f32 H0_RxAbsorption;     // [dB per kilometer]
f32 H0_RxMountTilt;      // [radians]
u32 H0_RxMiscInfo;       // reserved for future use
u16 H0_reserved;         // reserved for future use
u16 H0_Beams;            // number of beams

// section A1: float beam angles, arbitrarily-spaced (only one per ping)

u16 A1_SectionName;      // 'A1'
u16 A1_SectionSize;      // [bytes] size of this entire section
f32 A1_MoreInfo[6];      // reserved for future use
f32 A1_BeamAngle[H0_Beams]; // [radians] angle of beam relative to array centerline, ordered from port to starboard, first angle < last angle

// section M0: 8-bit magnitude data (many per ping, you assemble them into complete ping data)

u16 M0_SectionName;      // 'M0'
u16 M0_SectionSize;      // [bytes] size of this entire section
u32 M0_PingNumber;       // pings since power-up or reboot
f32 M0_ScalingFactor;    // reserved for future use
u32 M0_TotalSamples;     // range samples (before compression) in entire ping, sample rate is H0_RxSampleRate
u32 M0_TotalBins;        // range bins (after compression) in entire ping (M0_TotalBins <= M0_TotalSamples)
u32 M0_FirstBin;         // first bin of this section
u16 M0_Bins;             // number of bins in this section
u16 M0_TotalBeams;       // beams (always a multiple of 4) (typically columns in your memory buffer)
u16 M0_FirstBeam;        // first beam of this section (always a multiple of 4)
u16 M0_Beams;            // number of beams in this section (always a multiple of 4)
u32 M0_reserved;         // reserved for future use
struct
{
  u8 magnitude;          // values 0 to 255 map non-linearly (due to TVG scaling and possible gain compression) to signal amplitude
} M0_Data[M0_Beams][M0_Bins]; // magnitude data (typical example: 256 beams each containing 21 one-byte structs, 5376 bytes)

// *** END PACKET: ACOUSTIC IMAGE (AI) DATA FORMAT 0 ***

```

Version	3.3	Rev	r000
Date	13-04-2017		

15.10 TruePix™ Data Format

```
// *** BEGIN TRUEPIX DATA FORMAT 0 ***
// TruePix is like sidescan with 3D relief. Each sonar ping produces a port
// and starboard time-series of data samples at the sonar's sample rate. Each
// sample contains the signal's magnitude (like sidescan) and across-track
// target direction angle (like bathymetry). After collecting many pings of
// data along a survey line, you now have a large array of data points with
// range, direction, and brightness. Apply noise reduction, and render the
// data as a textured 3D surface.
//
// Two data formats are available: D0 provides magnitudes only, D1 provides
// magnitudes and direction angles. The GUI allows the user to choose the
// desired format.
//
// The sonar generates one TruePix data set per ping. Each data set is
// usually split into multiple UDP packets. The D0 or D1 header includes
// FirstSample and Samples values to help you reassemble the full data set.
//
// Someday you may be able to convert the 16-bit magnitude values to
// micropascals by applying a to-be-determined function involving the sample
// number and the MagnitudeScaling[] coefficients, but this conversion is not
// yet supported so these coefficients are zero. You can convert the
// direction angles from 16-bit values to radians by multiplying by
// AngleScalingFactor.

u32 PacketName;           // 'TPX0'
u32 PacketSize;          // may be zero in UDP, otherwise: [bytes] size of this entire packet
u32 DataStreamID;        // reserved for future use

// section H0: header (present only in first packet of each ping)
u16 H0_SectionName;      // 'H0'
u16 H0_SectionSize;      // [bytes] size of this entire section
u8 H0_ModelNumber[12];   // example "2024", unused chars are nulls
u8 H0_SerialNumber[12];  // example "100017", unused chars are nulls
u32 H0_TimeSeconds;      // [seconds] ping time relative to 0000 hours 1-Jan-1970, integer part
u32 H0_TimeNanoseconds;  // [nanoseconds] ping time relative to 0000 hours 1-Jan-1970, fraction part
u32 H0_PingNumber;       // pings since power-up or reboot
f32 H0_PingPeriod;       // [seconds] time between most recent two pings
f32 H0_SoundSpeed;       // [meters per second]
f32 H0_Frequency;        // [hertz] sonar center frequency
f32 H0_TxPower;          // [dB re 1 uPa at 1 meter]
f32 H0_TxPulseWidth;     // [seconds]
f32 H0_TxBeamwidthVert;  // [radians]
f32 H0_TxBeamwidthHoriz; // [radians]
f32 H0_TxSteeringVert;   // [radians]
f32 H0_TxSteeringHoriz;  // [radians]
u16 H0_2026ProjTemp;     // [hundredths of a degree Kelvin] 2026 projector temperature (divide value by 100, subtract 273.15 to get °C)
s16 H0_VTx+Offset;       // [hundredths of a dB] transmit voltage offset at time of ping (divide value by 100 to get dB)
f32 H0_RxBandwidth;      // [hertz]
```

Version	3.3	Rev	r000
Date	13-04-2017		

```

f32 H0_RxSampleRate;          // [hertz] sample rate of data acquisition and signal processing
f32 H0_RxRange;              // user setting [meters]
f32 H0_RxGain;               // user setting [multiply by 2 for dB]
f32 H0_RxSpreading;         // [dB (times log range in meters)]
f32 H0_RxAbsorption;        // [dB per kilometer]
f32 H0_RxMountTilt;         // [radians]
u32 H0_RxMiscInfo;          // reserved for future use
u32 H0_reserved;            // reserved for future use
f32 H0_MoreInfo[6];         // reserved for future use

// section D0: 16-bit magnitude data (present only during "magnitude only" mode)
u16 D0_SectionName;         // 'D0'
u16 D0_SectionSize;         // [bytes] size of this entire section
u32 D0_PingNumber;          // pings since power-up or reboot
u32 D0_TotalSamples;        // number of samples in entire time series (sample rate is H0_RxSampleRate)
u32 D0_FirstSample;        // first sample of this section relative to zero range
u16 D0_Samples;            // number of samples in this section
u16 D0_reserved;           // reserved for future use
f32 D0_MagnitudeScaling[8]; // to be determined, 0=ignore
struct
{
  u16 PortMagnitude;        // [micropascals] = PortMagnitude * (tbd function of sample number and D0_MagnitudeScaling[8])
  u16 StbdMagnitude;        // similar but starboard side
} D0_Data[D0_Samples];

// section D1: 16-bit magnitude and direction data (present only during "magnitude+direction" mode)

u16 D1_SectionName;        // 'D1'
u16 D1_SectionSize;        // [bytes] size of this entire section
u32 D1_PingNumber;         // pings since power-up or reboot
u32 D1_TotalSamples;       // number of samples in entire time series (sample rate is H0_RxSampleRate)
u32 D1_FirstSample;        // first sample of this section relative to zero range
u16 D1_Samples;           // number of samples in this section
u16 D1_reserved;          // reserved for future use
f32 D1_MagnitudeScaling[8]; // to be determined, 0=ignore
f32 D1_AngleScalingFactor;
struct
{
  u16 PortMagnitude;        // [micropascals] = PortMagnitude * (tbd function of sample number and D1_MagnitudeScaling[8])
  s16 PortAngle;           // [radians from array centerline (positive towards starboard)] = PortAngle * D1_AngleScalingFactor
  u16 StbdMagnitude;        // similar but starboard side
  s16 StbdAngle;           // similar but starboard side
} D1_Data[D1_Samples];

// *** END TRUEPIX DATA FORMAT 0 ***

```

Version	3.3	Rev	r000
Date	13-04-2017		

15.11 Head Status Format

```
// *** BEGIN PACKET: HEAD STATUS DATA FORMAT 0 ***
// Head Status data reports the status of the sonar head. This data is
// useful for troubleshooting. Data is sent to gui baseport + 2.
//
// Each section name consists of 4 characters. The fourth character
// indicates the number of 32-bit words following each section name.
// The fourth character can be 1-9, A-Z; allowing up to 35 32-bit words.
// The number of words in each section may change at a later date. Be
// sure your program can parse the number of words.
// The order of the sections is not fixed.

u32 PacketName;           // 'STH0'
u32 PacketSize;          // [bytes] size of this entire packet
u32 DataStreamID;        // reserved for future use

// section SER3: serial number

u32 SER3_SectionName;    // 'SER3'
u32 serial_number[3];    // example "100117", unused chars are nuls

// section PRT3: part number

u32 PRT3_SectionName;    // 'PRT3'
u32 part_number[3];      // example "15000001", unused chars are nuls

// section MDL3: model number

u32 MDL3_SectionName;    // 'MDL3'
u32 model_number[3];     // example "2024", unused chars are nuls

// section FWV6: main controller firmware version

u32 'FWV6';              // main ctrl firmware version string
u32 version.i[6];        // example "19-Dec-2011-17:19:29", unused chars are nuls

// section FWT6: internal transmitter firmware version

u32 FWT6_SectionName;    // 'FWT6'
u32 tinytx.i[6];         // example "16-Aug-2011-17:19:29", unused chars are nuls

// section PRJ9: projector

u32 PRJ9_SectionName;    // 'PRJ9'
u32 serial_number[3];    // example "800456", unused chars are nuls
u32 part_number[3];      // example "15000004", unused chars are nuls
u32 model_number[3];     // example "1004", unused chars are nuls
```

Version	3.3	Rev	r000
Date	13-04-2017		

```
// section OPT1: option settings

u32 OPT1_SectionName      // 'OPT1'
u32 options                //...truepix_snippets[0:0]      0=off, 1=on
                        //...depth_rating[1:1]      0=100m, 1=3km
                        //...forward_looking[2:2]    0=off, 1=on
                        //...water_column[3:3]      0=off, 1=on
                        //...ultra-high resolution[4:4] 0=off, 1=on
                        //...water column rx chan [5:5] 0=off, 1=on
                        //.. 2026 low freq option [6:6] 0=off, 1=90 & 100kHz enabled, 2026 only

// section CFG8: configuration parameters
u32 CFG8_SectionName;     // 'CFG8'
f32 pdepth_cutout;        // [meters] pressure cutout depth (no bathy detect below this depth)
f32 pdepth_export_depth;  // [meters] pressure trigger for export control (limits lowest freq and range)
f32 pdepth_export_bathyrange; // [meters] max bathy range when pressure trigger is exceeded
f32 pdepth_export_minfreq; // [Hz] min freq when pressure trigger is exceeded
f32 option_lowfreq;       // [Hz] low-frequency option
f32 pdepth_export_bathydepth; // [meters] max bathy depth allowed
f32 spare0;               // spare
f32 spare1;               // spare

// section OPR4: operational parameters so GUI can configure its menus
u32 OPR4_SectionName;     // 'OPR4'
f32 opr_minfreq;          // [Hz] current minimum selectable frequency (zero means ignore me and use GUI default)
f32 opr_maxfreq;          // [Hz] current maximum selectable frequency (zero means ignore me and use 400kHz default)
f32 spare0;               // spare
f32 spare1;               // spare

// section SENa: sensor data received from SIM

u32 SENa_SectionName;     // 'SENa'
u32 gps.time.sec;         // [seconds]unix time
u32 gps.time.nsec;        // [seconds = gps.time.nsec/(2^32)] unix time
f32 sensor.pitch;         // [radians] mru pitch
f32 sensor.roll;          // [radians] mru roll
f32 sensor.heave;         // [meters] mru heave
f32 sensor.heading;       // heading (not implemented)
f32 sensor.velocity;      // [m/s] sound velocity
f32 sensor.pdepth.uncal;  // [meters] depth uncalibrated
f32 sensor.pdepth.cal;    // [meters] depth calibrated
f32 sensor.fpgatemp;      // [°C] FPGA temperature

// section ADC3: a/d converter

u32 ADC3_SectionName;     // 'ADC3'
f32 adc.chan0;            // [volts] 48VDC power supply voltage
f32 adc.chan1;            // [amperes] 48V current
f32 adc.chan8;            // [volts] transmitter power supply voltage
```

Version	3.3	Rev	r000
Date	13-04-2017		



```
// section ETH6; ethernet registers

u32 ETH6_SectionName;      // 'ETH6'
u32 ethernet.speed;       // [megabits/sec] link connect speed
u32 erxpackets;           // [counts] ethernet receive packets
u32 etxpackets;           // [counts] ethernet transmit packets
u32 erxoverflows;         // [counts] ethernet receive buffer overflows
u8  mac.addr[8];          // mac address, use last 6 bytes, first 2 bytes are not used

// section TIM2; timers

u32 TIM2_SectionName      // 'TIM2'
f32 time.check;           // [seconds]head to SIM roundtrip time response (must be less than 3ms)
f32 time.spare;           // [seconds] spare

// *** END PACKET: HEAD STATUS DATA FORMAT 0 ***
```

Version	3.3	Rev	r000
Date	13-04-2017		

Part No. 96000005

15.12 SIM Status Data Format

```
// *** BEGIN PACKET: SIM STATUS DATA FORMAT 0 ***
// SIM Status data reports misc info from the SIM box. This data is
// useful for troubleshooting. Data is sent to gui baseport+2.
//
// Each section name consists of 4 characters. The fourth character
// indicates the number of 32-bit words following each section name.
// The fourth character can be 1-9, A-Z; allowing up to 35 32-bit words.
// The number of words in each section may change at a later date. Be
// sure your program can parse the number of words.
// The order of the sections is not fixed.

u32 PacketName;           // 'STS0'
u32 PacketSize;          // [bytes] size of this entire packet
u32 DataStreamID;        // reserved for future use

// section SER3: serial number

u32 SER3_SectionName;    // 'SER3'
u32 serial_number[3];    // example "100117", unused chars are nulls

// section PRT3: part number

u32 PRT3_SectionName;    // 'PRT3'
u32 part_number[3];      // example "15000002", unused chars are nulls

// section MDL3: model number

u32 MDL3_SectionName;    // 'MDL3'
u32 model_number[3];     // example "2024", unused chars are nulls

// section FWV6: firmware version

u32 FWV6_SectionName;    // 'FWV6'
u32 version;             // example "15-Dec-2011-14:00:42", unused chars are nulls
```

Version	3.3	Rev	r000
Date	13-04-2017		

```
// section LED1: SIM front panel LED status

u32 LED1_SectonName;      // 'LED1'
u32 led_status;          // [00=off 01=undef 10=bad 11=good] flags for status LEDs
                        // gps[1:0]
                        // motion[3:2]
                        // heading[5:4], not implemented
                        // svp[7:6]
                        // alt-gps[9:8], not implemented
                        // alt-motion[11:10], not implemented
                        // alt-heading[13:12], not implemented
                        // alt-svp[15:14], not implemented
                        // pps[17:16]
                        // sync in[19:18]
                        // sync out[21:20]
                        // head on[23:22]
                        // reserved[31:24]

// section SEN7: RS232 sensor values

u32 SEN7_SectonName;     // 'SEN7'
u32 gps.time.sec;       // [seconds] unix time
u32 gps.time.nsec;     // [seconds = gps.time.nsec/(2^32)] unix time
f32 mru.pitch;         // [radians] mru pitch value
f32 mru.roll;          // [radians] mru roll value
f32 mru.heave;         // [meters] mru heave
f32 0.0;               // heading (not implemented)
f32 svp.velocity;      // [m/s] sound velocity

// section ADC2: a/d converter

u32 ADC2_SectonName;    // 'ADC2'
f32 adc.chan0;         // [volts] 48VDC power supply voltage
f32 adc.chan1;         // [amperes] 48V current to head

// section ETH6: ethernet registers

u32 ETH6_SectonName;    // 'ETH6'
u32 ethernet.speed;    // [megabits/sec] link speed
u32 erxpackets;        // [counts] ethernet receive packets
u32 etxpackets;        // [counts] ethernet transmit packets
u32 erxoverflows;      // [counts] ethernet receive buffer overflows
u8 mac.addr[8];        // mac address, use last 6 bytes, first 2 bytes are not used

// *** END PACKET: SIM STATUS DATA FORMAT 0 ***
```

Version	3.3	Rev	r000
Date	13-04-2017		

15.13 Device Status Format

The device status packet contains the ConfigID number that was sent to the sonar head and SIM during IP configuration. This packet contains no survey information and is ignored for data collection purposes. The R2DS packet is sent from the sonar head and SIM once per second to the sonar control program IP address. The ConfigID received from the sonar head and SIM should be compared with the ConfigID number sent to the sonar head and SIM during IP configuration. If there is a mismatch, the control program should send IP configuration data to the sonar head and/or SIM to correct the issue.

```

struct R2DS                // R2Sonic Device Status
{
  u32  PacketName;         // 'R2DS'
  u32  SerialNumber[3];    // up to 12 ASCII chars, unused chars are zero
  u32  ConfigID;           // from most recent R2DC packet
  u32  spare;
} pkt;

```

C structure of Device Status packet

Device status Ethernet packet example received from the sonar head

```

0000  00 e0 81 2e be 88 00 50 c2 90 40 58 08 00 45 00  . . . . . P ..@ X..E.
0010  00 34 04 6c 00 00 32 11 6e 92 0a 00 00 56 0a 00  .4.l..2. n....V..
0020  01 66 ff 16 ff de 00 20 00 00 52 32 44 53 31 30  .f..... ..R2DS10
0030  30 31 30 31 00 00 00 00 00 00 46 35 bd 01 00 00  0101.... ..;~...
0040  00 00  ..

```

```

0000  00 e0 81 2e be 88 00 50 c2 90 40 49 08 00 45 00  . . . . . P ..@ I..E.
0010  00 34 02 75 00 00 32 11 70 7c 0a 00 00 63 0a 00  .4.u..2. p|...c..
0020  01 66 ff 7a ff de 00 20 00 00 52 32 44 53 31 30  .f.z... ..R2DS10
0030  30 30 34 34 00 00 00 00 00 00 46 35 bd 01 00 00  0044.... ..;~...
0040  00 00  ..

```

Device status Ethernet packet example received from the SIM

Version	3.3	Rev	r000
Date	13-04-2017		

15.14 Data Playback Using Bit-Twist

15.14.1 Introduction

Note, the topics covered in this document require knowledge of Ethernet communication.

To test a data collection system, you can either use the actual hardware (sonar head) or use data captured from the sonar head. Using Wireshark, uplink data from the sonar head can be captured, filtered, and saved. Bit Twist, a console application, allows you to playback data. R2Sonic can supply sample Ethernet captures of the sonar head uplink data. You may need to edit the destination MAC and IP addresses of the captured data with Bit-Twiste, a console application. Wireshark and Bit-Twist both require Winpcap which is included in the Wireshark installation.

In the examples, the following IP addresses are used:

Sonar head: 10.0.0.86
Data collection computer: 10.0.1.102

The following programs are required:

To capture, filter, and save Ethernet data:

Wireshark: <http://www.wireshark.org/>

To playback and edit captured Ethernet data:

Bit-Twist: <http://bittwist.sourceforge.net/>

Using a 32-bit version of Wireshark will allow you to use a packet decoder for the sonar data formats.

If you don't want or need to install Wireshark, get Winpcap at:

Winpcap: <http://www.winpcap.org/>

15.14.2 Capturing Data

To capture data from the sonar head, use Wireshark. Set the max ping rate of the sonar to 1 to 5 pings per second so you won't create huge capture files.

- Capture sonar data. For high data rate traffic, set the following Wireshark Capture Options. These options are found under the button (usually left most) "List the available capture interfaces...". These setting will remain for the session.
 - Buffer size: 50 megabytes
 - Uncheck "Update list of packets in real time"

Version	3.3	REV	r000
Date	13-04-2017		

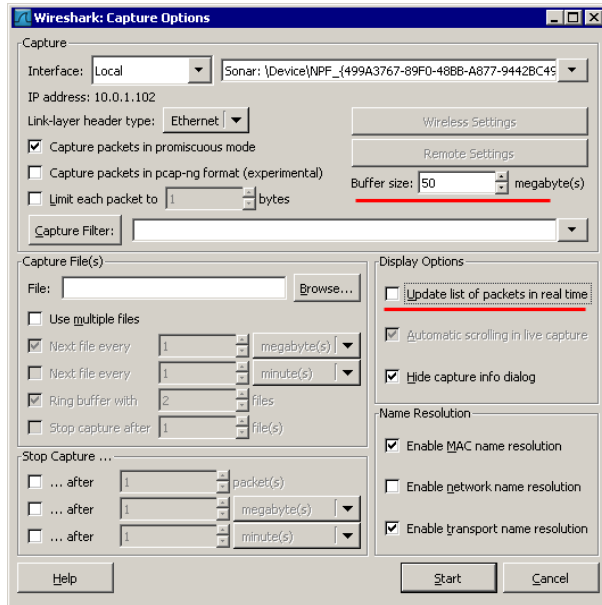

Figure 186: Wireshark Capture Options

This will reduce the processing load on Wireshark significantly.

- After capture, filter the data so only the desired sonar head data is displayed. A filter expression like

`"not(icmp.type == 3 or ip.src == 10.0.1.102)"`

can be used to filter data coming from the data acquisition computer.

- Save using Save As, data type as "Wireshark/tcpdump/...- libpcap (*.pcap,*.cap)" (Wireshark default). Select "Displayed" in Packet Range. You can select a data range in the Packet Range such that the data packets aren't truncated.

15.14.3 Editing Data

The MAC and IP addresses in the packets must match the data acquisition computer's MAC and IP addresses assigned to the network interface card (NIC). The data acquisition computer's MAC and IP addresses can be determined using `ipconfig /all` from the command line.

Editing the MAC and IP addresses must be done as separate operations using `bittwiste.exe`. The following examples show the syntax for editing the destination MAC and IP address in the .pcap files created by Wireshark.

Example to change destination MAC address using `bittwiste.exe`:
`bittwiste -I in.pcap -O out.pcap -T eth -d 00:E0:12:7F:D2:1A`

Example to change destination IP address using `bittwiste.exe`:
`bittwiste -I in.pcap -O out.pcap -T ip -d 10.0.1.102`

Where `in.pcap` is the input file and `out.pcap` is the output file.

Version	3.3	Rev	r000
Date	13-04-2017		

15.14.4 Data Playback

To playback data, use `bittwist.exe`. You can playback data on the same computer that the data collection program resides on by simply connecting the sonar Ethernet port to an Ethernet switch. The Ethernet switch is only to placate the NIC. You can also send data from a remote computer to the data acquisition computer.

You need to determine the Ethernet interface number. Choose the interface that is connected to the sonar system. To display Ethernet interfaces:

```
bittwist -d
```

To playback data:

```
bittwist -i 2 -l 0 out.pcap
```

This sends `out.pcap` to Ethernet interface 2 (`-i 2`) and loops continuously (`-l 0`). Use `Ctrl-C` to exit the program.

If you don't want to loop, use:

```
bittwist -i 2 out.pcap
```

Note:

Newer Ethernet playback utilities are better than `bittwist`. Ask support about a modified version of `Playcap.exe` (Open Source program modified for looping) and `Wireplay.exe` (R2Sonic program that can play back pcap files at full speed and you don't need to edit pcap files with `bittwiste`).

`Wireplay.exe` is the recommended playback utility. `Wireplay` is available from R2Sonic

Appendix X – Drawings

16 APPENDIX X: Drawings

Drawing Index

Figure 187: Sonic 2020.....	208
Figure 188: Sonic 2020 array face in mounting frame.....	209
Figure 189: Sonic 2020 front view, in mounting frame	210
Figure 190: Sonic 2020 mounting frame, top view, flange attachment	211
Figure 191: R2C 2020 Mounting Bracket	212
Figure 192: R2C Flange.....	213
Figure 193: SIM Box Drawing.....	214
Figure 194: SIM Stack Outline.....	215
Figure 195: R2Sonic Deck lead minimum connector passage dimensions	216
Figure 196: I2NS IMU Dimensions	217
Figure 197: I2NS SIM Dimensions	218

Version	3.3	REV	r000
Date	13-04-2017		

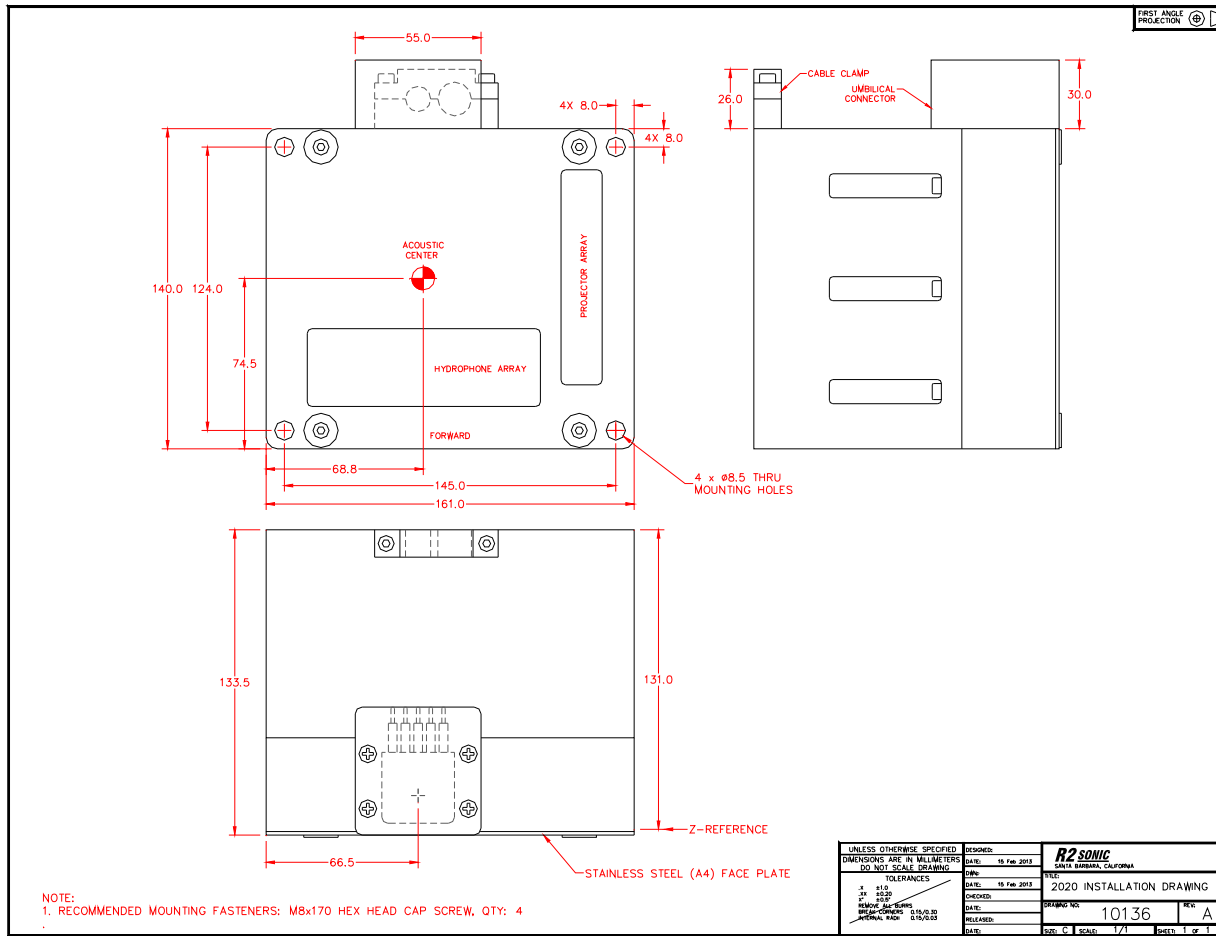

Figure 187: Sonic 2020

Version	3.3	Rev	r000
Date	13-04-2017		

Part No. 96000005

Forward

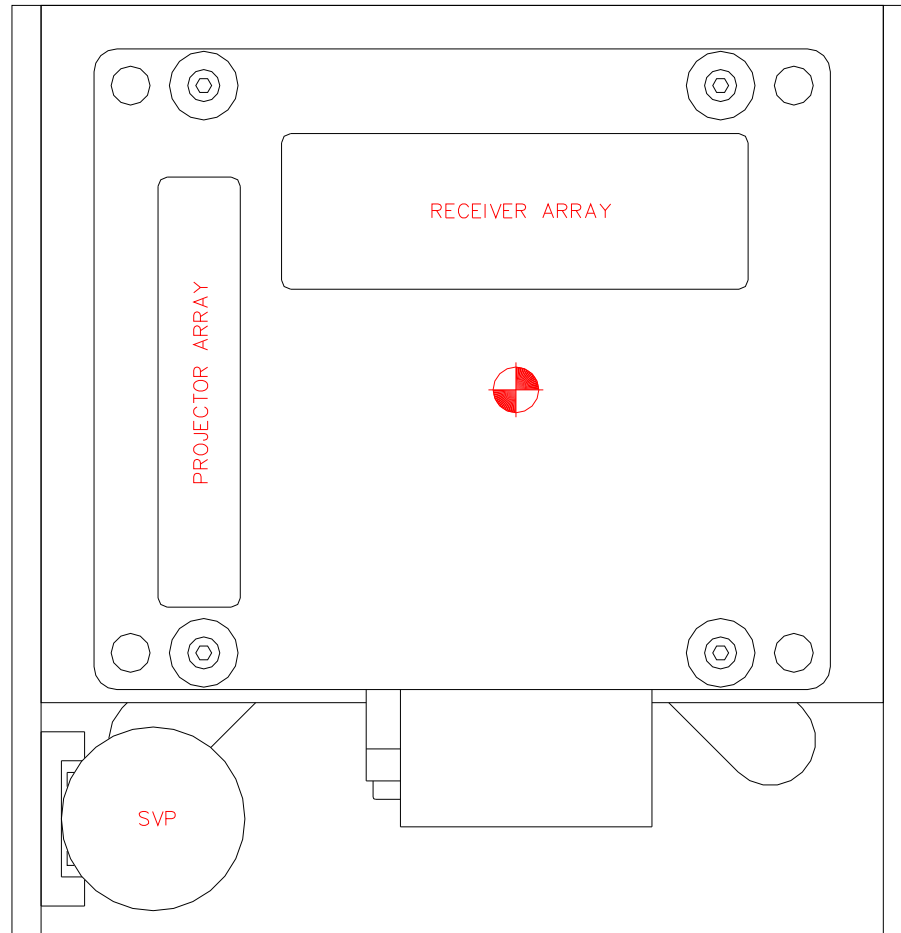

Figure 188: Sonic 2020 array face in mounting frame

Version	3.3	Rev	r000
Date	13-04-2017		

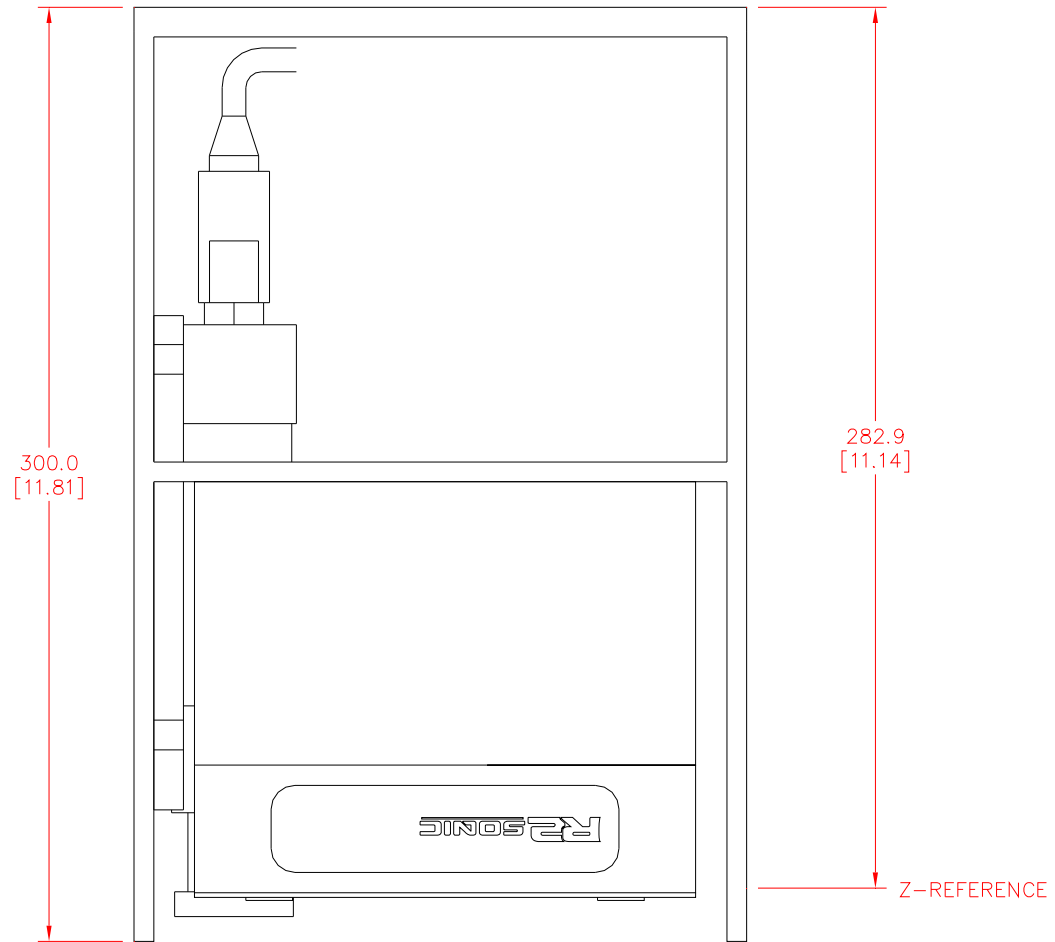

Figure 189: Sonic 2020 front view, in mounting frame

Version	3.3	Rev	r000
Date	13-04-2017		

Part No. 96000005

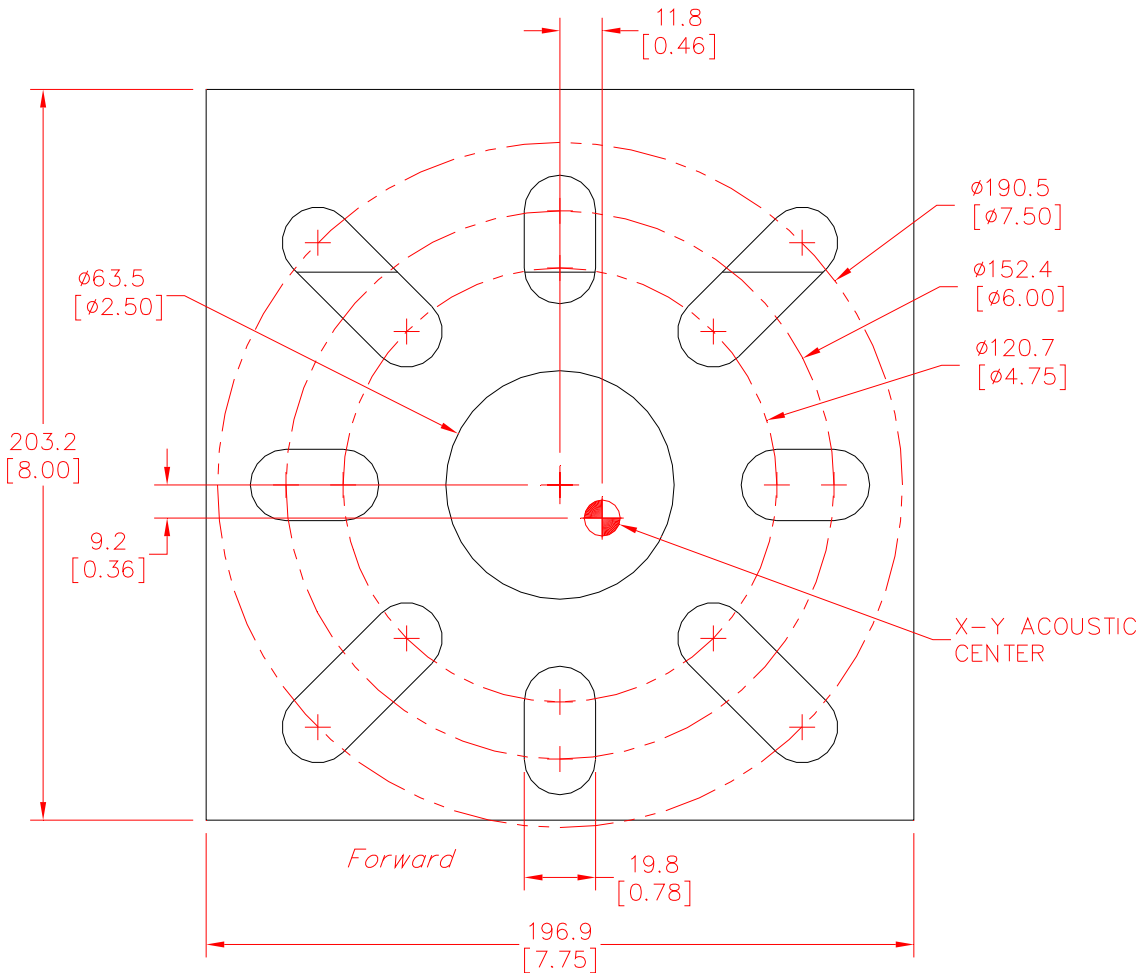

Figure 190: Sonic 2020 mounting frame, top view, flange attachment

Version	3.3	Rev	r000
Date	13-04-2017		

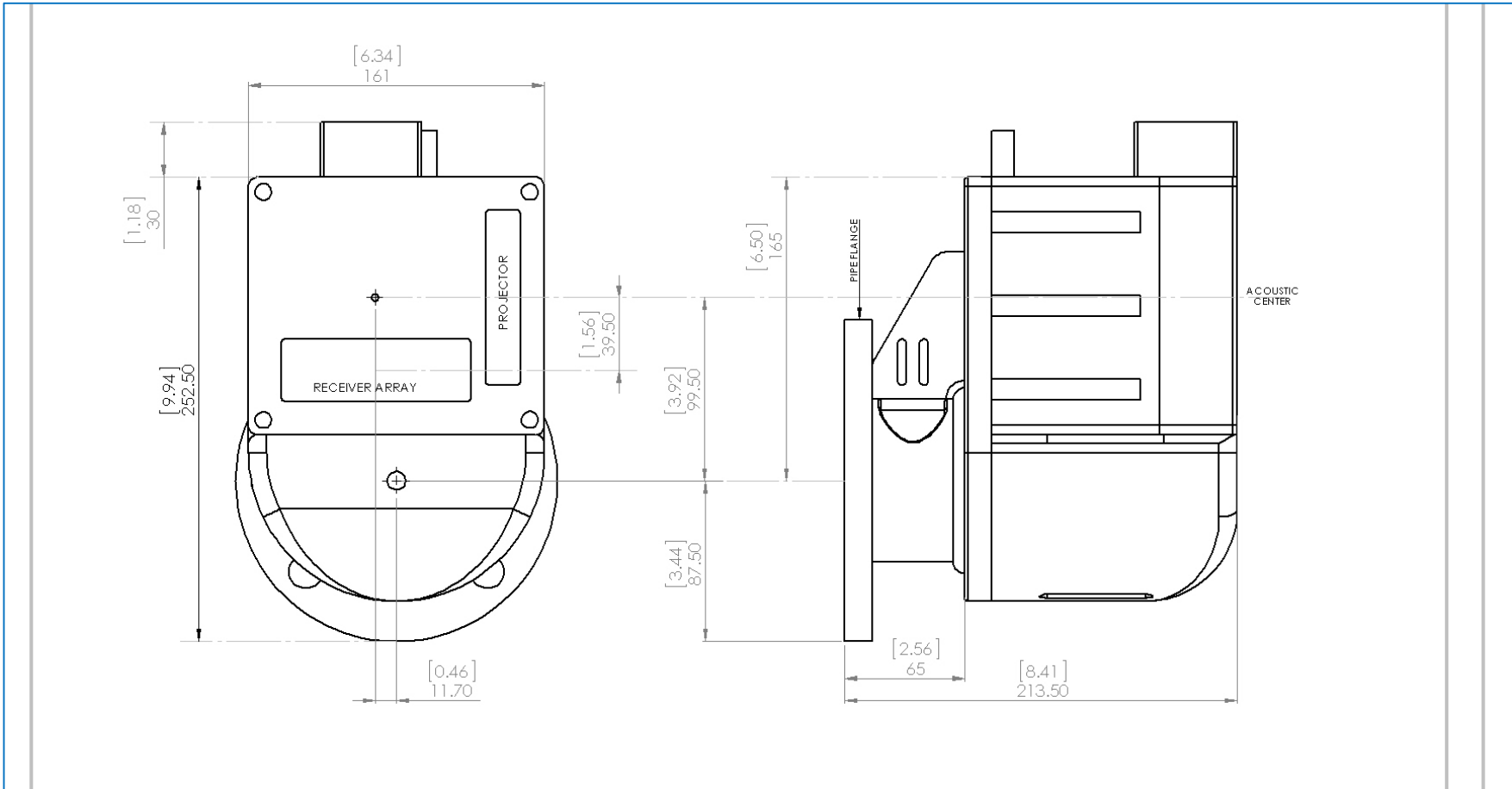

Figure 191: R2C 2020 Mounting Bracket

Version	3.3	Rev	r000
Date	13-04-2017		

Part No. 96000005

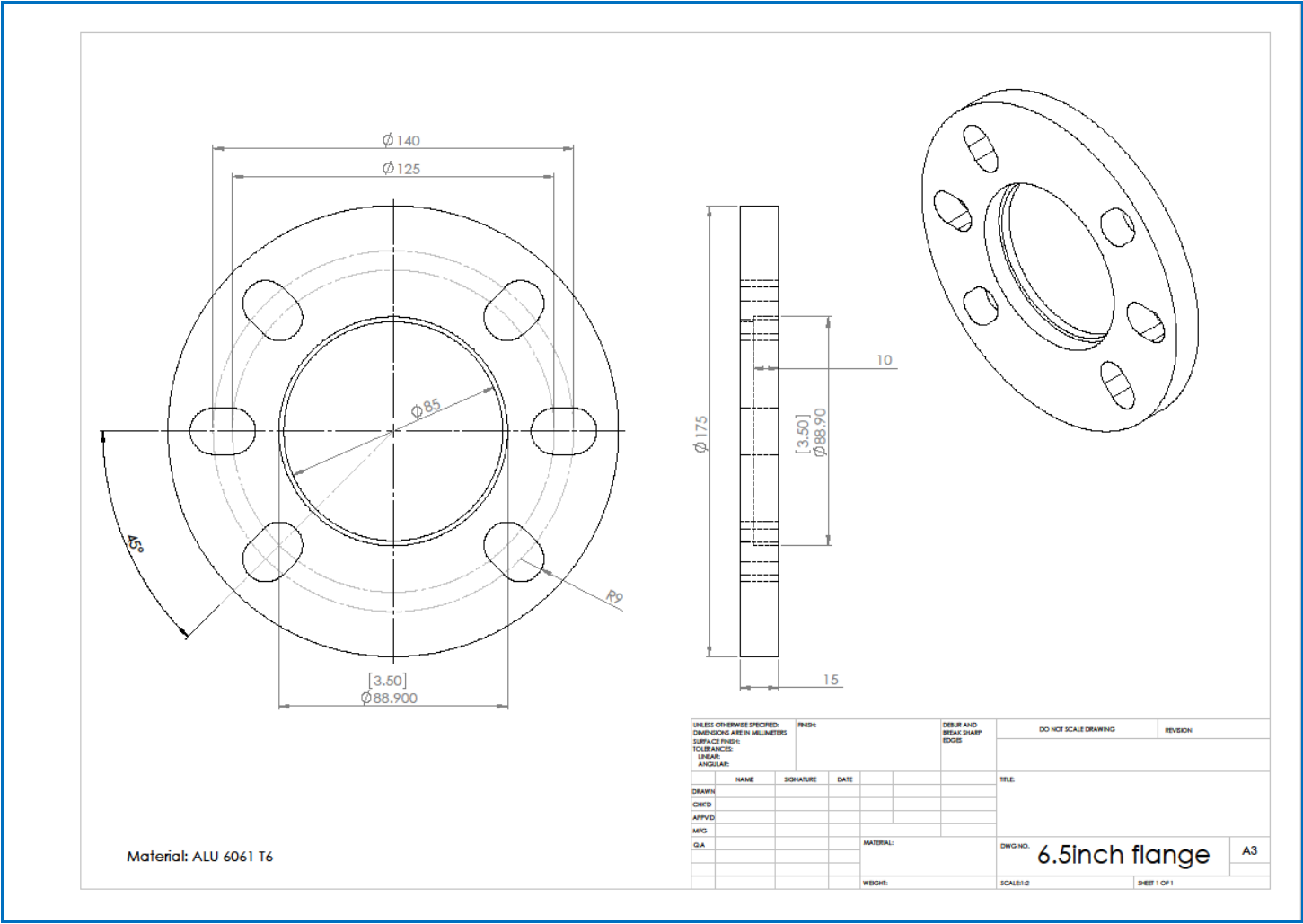

Figure 192: R2C Flange

Version	3.3	Rev	r000
Date	13-04-2017		

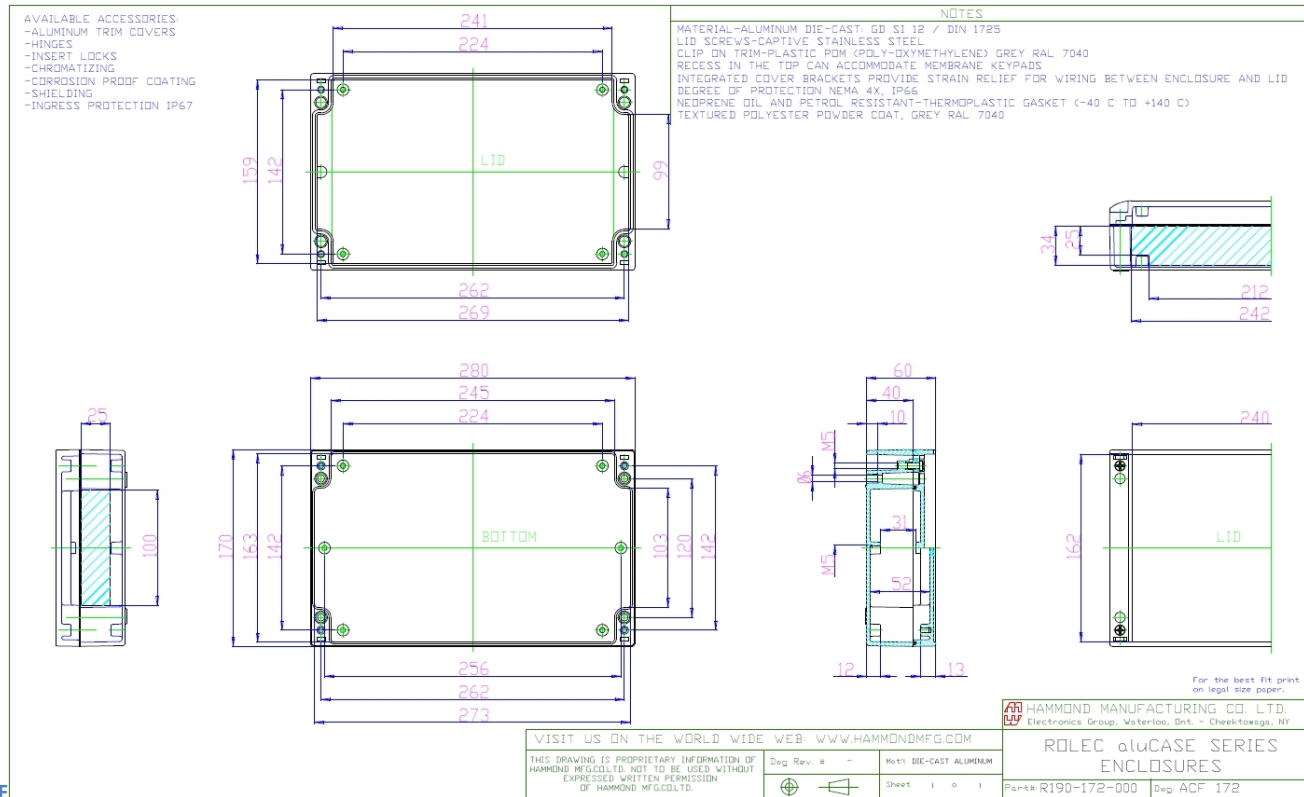

Figure 193: SIM Box Drawing

Version	3.3	Rev	r000
Date	13-04-2017		

Part No. 96000005

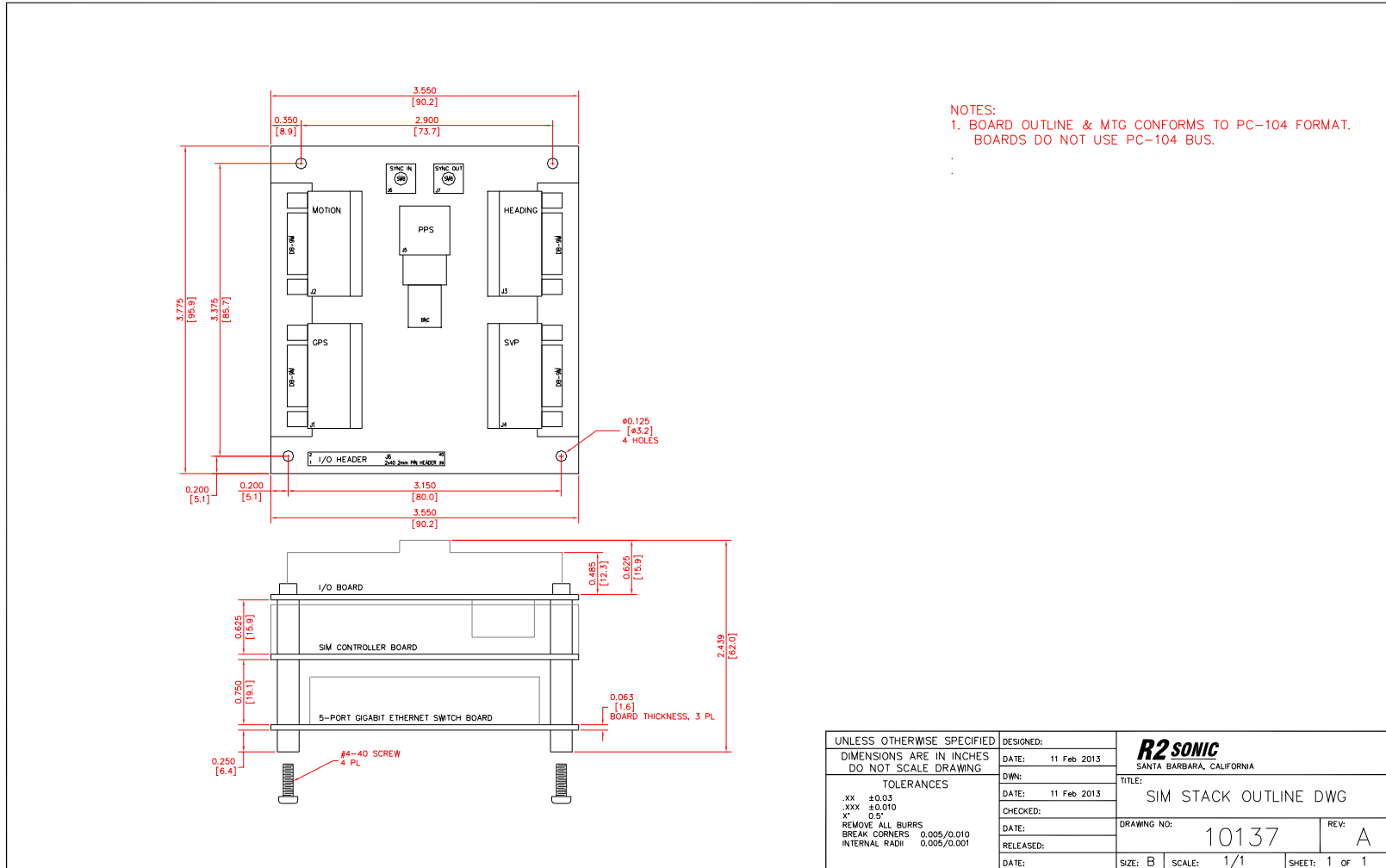

Figure 194: SIM Stack Outline

Version	3.3	Rev	r000
Date	13-04-2017		

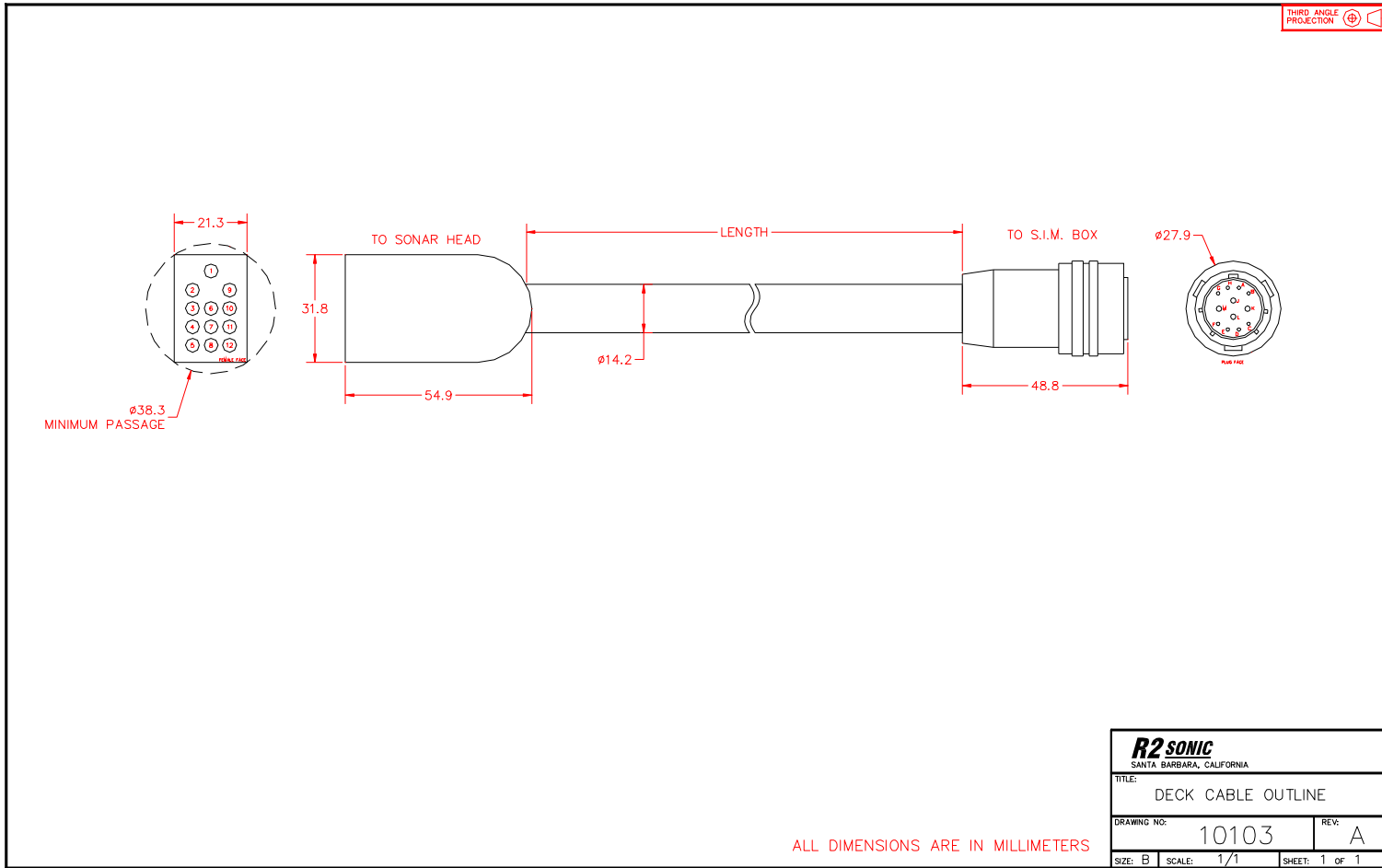

Figure 195: R2Sonic Deck lead minimum connector passage dimensions

Version	3.3	Rev	r000
Date	13-04-2017		

Part No. 96000005

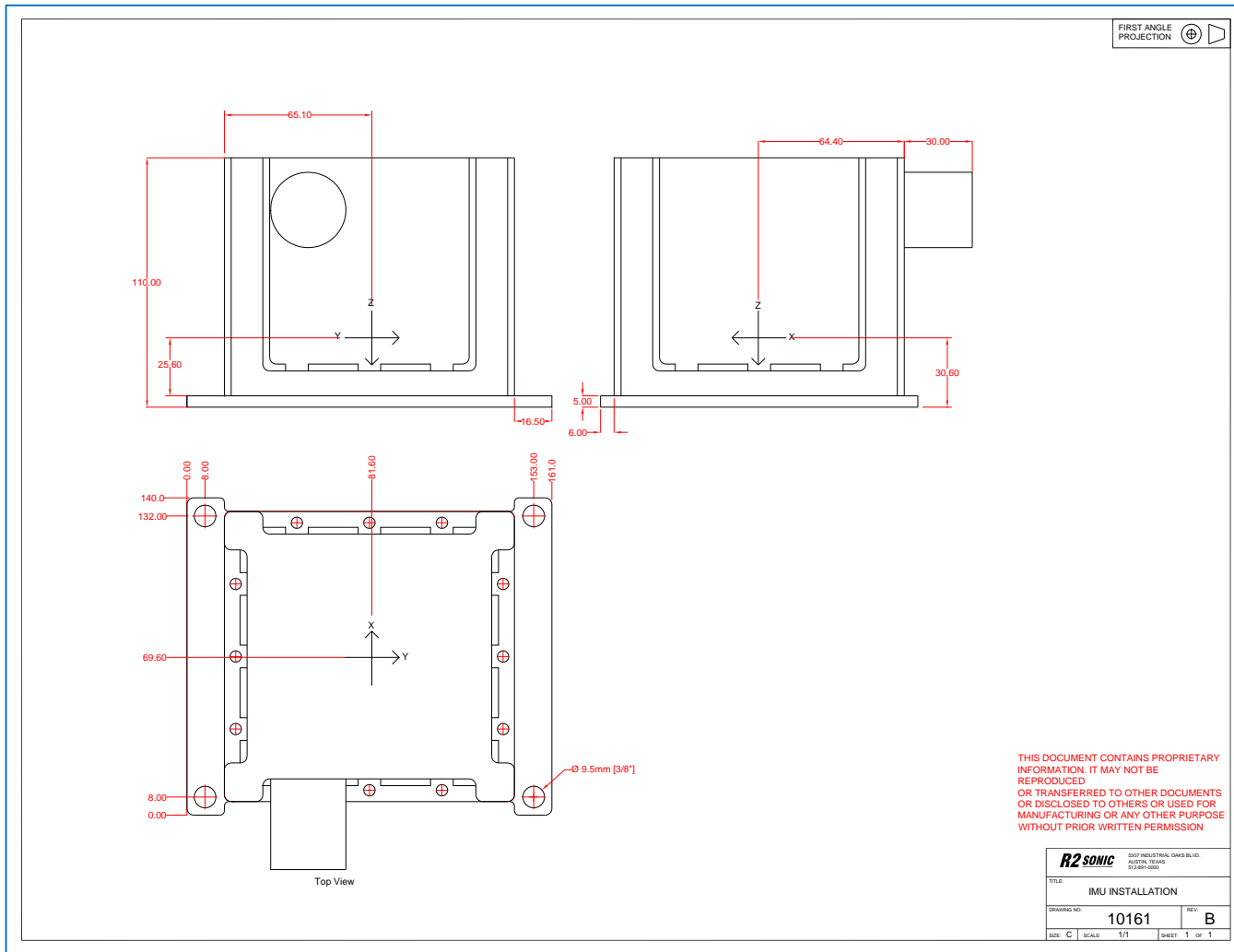

Figure 196: I2NS IMU Dimensions

Version	3.3	Rev	r000
Date	13-04-2017		

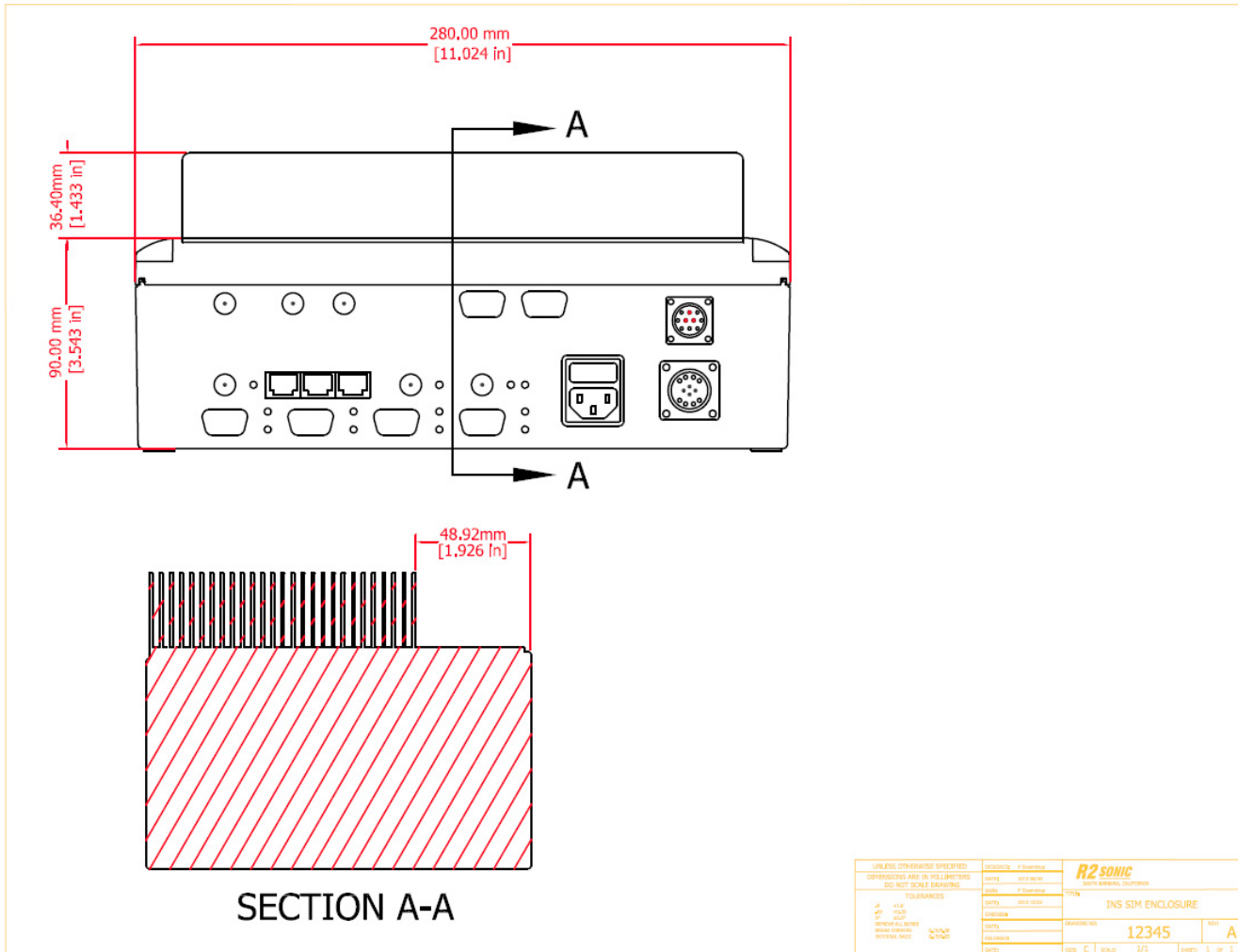

Figure 197: I2NS SIM Dimensions

Version	3.3	Rev	r000
Date	13-04-2017		

Part No. 96000005