



Vector VS330 GNSS Compass

User Guide

Part No. 875-0323-000 Rev. B1



This device complies with part 15 of the FCC Rules. Operation is subject to the following two conditions:

- (1) This device may not cause harmful interference, and
- (2) this device must accept any interference received, including interference that may cause undesired operation.

Copyright Notice

Copyright Hemisphere GNSS, Inc. (2013). All rights reserved.

No part of this manual may be reproduced, transmitted, transcribed, stored in a retrieval system or translated into any language or computer language, in any form or by any means, electronic, mechanical, magnetic, optical, chemical, manual or otherwise, without the prior written permission of Hemisphere GNSS.

Trademarks

Hemisphere GPS[®], the Hemisphere GPS logo, COAST[™], Crescent[®], Earthworks[®], Eclipse[™], e-Dif[®], L-Dif[™], miniEclipse[™], PocketMAX PC[™], PocketMAX[™], PocketMax3[™], S320[™], SBX-4[™], SureTrack[®], Vector[™], XF1[™], and XF2[™] are proprietary trademarks of Hemisphere GNSS, Inc. Other trademarks are the properties of their respective owners.

Patents

Hemisphere GNSS products may be covered by one or more of the following patents:

U.S. Patents				Australia Patents	
6111549	6876920	7400956	8000381	8214111	2002244539
6397147	7142956	7429952	8018376	8217833	2002325645
6469663	7162348	7437230	8085196	8265826	2004320401
6501346	7277792	7460942	8102325	8271194	
6539303	7292185	7689354	8138970	8307535	
6549091	7292186	7808428	8140223	8311696	
6711501	7373231	7835832	8174437	8334804	
6744404	7388539	7885745	8184050	RE41358	
6865465	7400294	7948769	8190337		

Other U.S. and foreign patents pending.

Notice to Customers

Contact your local dealer for technical assistance. To find the authorized dealer near you:

Hemisphere GNSS, Inc.
8444 N 90th St, Suite 120
Scottsdale, AZ 85258 USA
Phone: (480) 348-9919
Fax: (480) 348-6370
precision@hemispheregps.com
www.hemispheregps.com

Technical Support

If you need to contact Hemisphere GNSS Technical Support:

Hemisphere GNSS, Inc.
8444 N 90th St, Suite 120
Scottsdale, AZ 85258 USA
Phone: (480) 348-9919
Fax: (480) 348-6370
techsupport@hemispheregps.com

Documentation Feedback

Hemisphere GNSS is committed to the quality and continuous improvement of our products and services. We urge you to provide Hemisphere GNSS with any feedback regarding this guide by writing to the following email address: techsupport@hemispheregps.com.

Contents

Chapter 1	Introduction	1
	What's In This Guide?	2
	Product Overview and Features	2
	Key Features	3
	What's Included in Your Kit	3
	Using VectorPC to Communicate with the VS330	4
Chapter 2	Understanding the VS330	5
	GNSS Overview	6
	GNSS Operation	6
	Differential Operation	6
	VS330 Overview	8
	Fixed Baseline Moving Base Station RTK	8
	GLONASS	9
	L2 Advantages	9
	Supplemental Sensors	9
	Time Constants	10
Chapter 3	Installing the VS330	13
	Mounting the Antennas	14
	Antenna Options	14
	Mounting Orientation	14
	Planning the Optimal Antenna Placement	15
	Mounting Options	16
	Routing and Securing the Antenna Cable	19
	Mounting the Receiver	20
	Routing and Connecting the Cables	21
	Connecting the Receiver to External Devices	22
	Default Parameters	24
Chapter 4	Operating the VS330	25
	Powering the Receiver On/Off	26
	LED Indicators	27
	Startup	28
	Using the Menus	29
	Configuring the VS330	30
	Config Wizard Menu	30
	Using the Config Wizard	31
	Disabling the Aiding Features	33
	Disabling Tilt Aiding	33

Disabling Gyro Aiding	33
Adjusting the Time Constants	34
Connecting to Existing Navigation Systems	35
Viewing GNSS/DGPS Status	35
Do I Have a Signal?	35
How Good is the Quality of My Signal?	35
USB Data Logging	36
Selecting the Data File Type and Log Options	36
Logging Data to a File	38
Data Post-Processing	39
Appendix A Troubleshooting	41
Appendix B FAQ	45
Appendix C Menu Map	49
Vector Menu	50
GNSS Menu	51
Differential Menu	52
Config Wizard Menu	54
System Setup Menu	55
Data Logging Menu	56
Appendix D Technical Specifications	57
VS330 Receiver Specifications	58
A42 Antenna Specifications	61
A43 Antenna Specifications	62
A52 Antenna Specifications	64
Index	65
End User License Agreement	67
Warranty Notice	70



Chapter 1: Introduction

What's In This Guide?

Product Overview and Features

What's Included in Your Kit

Using VectorPC to Communicate with the VS330

What's In This Guide?

This user guide provides the following information to get you up and running quickly with your Vector™ VS330™ GNSS compass.

- This chapter briefly describes the VS330 and the parts in your VS330 kit.
- Chapter 2, “Understanding the VS330” discusses GPS and differential operation as well as sensors and time constants related to the VS330.
- Chapter 3, “Installing the VS330” describes how to mount the antennas and receiver, connect the cables, and power the system.
- Chapter 4, “Operating the VS330” provides instructions on configuring the receiver, disabling aiding features, adjusting the time constants, and operating the receiver.
- Appendix A, “Troubleshooting” provides possible solutions for issues.
- Appendix B, “FAQ” includes answer to common questions.
- Appendix C, “Menu Map” provides a full map of all system menus.
- Appendix D, “Technical Specifications” lists the technical specifications of the VS330 and the included antennas.

Note: Throughout the rest of this user guide the Vector VS330 GNSS Compass is referred to simply as the VS330.

Product Overview and Features

Based on Eclipse™ GNSS technology, the VS330 (Figure) is designed for precise marine and land applications that require precise heading and RTK position performance from the Vector VS330 GNSS compass. Featuring a Hemisphere GPS Eclipse Vector-based receiver and two separate antennas, VS330 achieves heading accuracy ranging from 0.01° to 0.17° rms (depending on the antenna separation) and offers robust positioning performance.

With more accurate code phase measurements, improved multipath mitigation, and fewer components than competing products, VS330 offers superior accuracy and stability.

The VS330 receiver, with its display and user interface, can be conveniently installed near the operator, while the two antennas are mounted separately with a user-determined separation (up to 10 m) to meet the desired accuracy.

VS330 uses L-band DGNSS(VBS/HP/XP/G2), SBAS (WAAS, EGNOS, MSAS, etc.), or beacon for differential GPS positioning—offering differential positioning performance of less than 0.5 m 95% of the time.

VS330 also features Hemisphere GPS' exclusive COAST™ technology that enables Hemisphere GPS receivers to utilize aging differential GPS correction data for 40 minutes or more without significantly affecting positioning quality. VS330 is less likely to be affected by differential signal outages due to signal blockages, weak signals, or interference when using COAST.



Key Features

Key features of the VS330 include:

- High-precision positioning in RTK, L1/L2, SBAS, beacon, and L-band (beacon and L-band require an unlock code)
- Heave of 30 cm rms (DGPS), 10 cm (RTK)
- Pitch and roll $< 1^\circ$ rms
- Simple menu operations
- Accurate heading up to 3 minutes during GPS outages
- Integrated gyro and tilt sensors deliver fast startup times and provide heading updates during temporary loss of GPS

What's Included in Your Kit

Your VS330 kit (Figure 1-1) includes the following parts:

- VS330 receiver and related mounting hardware
- Power and data cables

Note: The standard VS330 kit does not include antennas, antenna mounting hardware, and antenna cables since receiver options vary.

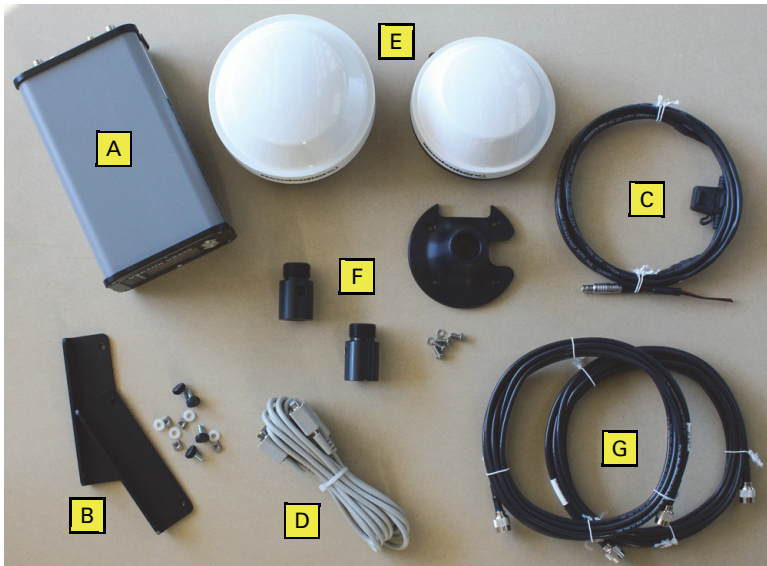

Figure 1-1: VS330 system parts diagram

Table 1-1 on page 4 provides the description and part number of each part in your kit.

Review the parts shipped with your kit. If any parts are damaged, contact your freight carrier. If any parts are missing, contact your dealer.

Table 1-1: Parts list

Item	Part Name	Qty	Part Number
A	VS330 receiver	1	803-3024-000#
B	Receiver mounting kit (two brackets and related hardware)	1	710-0056-000#
C	Power cable, circular	1	054-0146-000#
D	Data cable, DB-9 female to DB-9 male, 3 m	1	050-0011-022#
<i>The following are available for purchase separately from the standard VS330 kit.</i>			
E	Antenna (quantity of each based on your purchased configuration) A42 A43 A52		804-3045-000# 804-3046-000# 804-3038-000#
F	Antenna mounting kit (quantity of each based on your purchased configuration) A42 A43 A52 <i>Note: Your kit may not include a mag mount.</i>		710-0110-000# 710-0111-000# 710-0097-000#
G	Antenna cable, TNC male to TNC male, 5 m	2	052-0005-000#

Using VectorPC to Communicate with the VS330

Hemisphere GPS' VectorPC is a free utility program that runs on your Windows PC or Windows mobile device. Simply connect your Windows device to the VS330 via the COM port and open VectorPC. The screens within VectorPC allow you to easily interface with the VS330 to:

- Select the internal SBAS, beacon, or L-band correction source, if available, and monitor reception
- Configure GNSS message output and port settings
- Review heading, pitch, and roll visually
- Help calculate heading offset or heading bias

VectorPC is available for download from the OEM Software Downloads page on the Hemisphere GPS website (www.hemispheregps.com).



Chapter 2: Understanding the VS330

GNSS Overview

VS330 Overview

GNSS Overview

For your convenience, the GNSS operation of the VS330 features automatic operational algorithms. When powered for the first time, the VS330 performs a “cold start,” which involves acquiring the available GNSS satellites in view and the SBAS differential service.

If SBAS is not available in your area, an external source of RTCM SC-104 differential corrections may be used. If you use an external source of correction data, it must support an eight data bit, no parity, one stop bit configuration (8-N-1).

GNSS Operation

The GNSS receiver is always operating, regardless of the DGPS mode of operation. The following sections describe the general operation of the VS330’s internal GNSS receiver.

Note: Differential source and RTK status have no impact on heading, pitch, or roll. They only have an impact on positioning and heave.

Automatic Tracking

The VS330’s internal GPS receiver automatically searches for GNSS satellites, acquires the signals, and manages the navigation information required for positioning and tracking.

Receiver Performance

The VS330 works by finding four or more GNSS satellites in the visible sky. It uses information from the satellites to compute a position within 2.5 m. Since there is some error in the GNSS data calculations, the VS330 also tracks a differential correction. The VS330 uses these corrections to improve its position accuracy to better than 0.5 m.

There are two main aspects of GPS receiver performance:

- Satellite acquisition
- Positioning and heading calculation

When the VS330 is properly positioned, the satellites transmit coded information to the antennas on a specific frequency. This allows the receiver to calculate a range to each satellite from both antennas. GNSS is essentially a timing system. The ranges are calculated by timing how long it takes for the signal to reach the GNSS antenna. The GNSS receiver uses a complex algorithm incorporating satellite locations and ranges to each satellite to calculate the geographic location and heading. Reception of any four or more GNSS signals allows the receiver to compute three-dimensional coordinates and a valid heading.

Differential Operation

The purpose of differential GPS (DGPS) is to remove the effects of selective availability (SA), atmospheric errors, timing errors, and satellite orbit errors, while enhancing system integrity.

Autonomous positioning capabilities of the VS330 will result in positioning accuracies of 2.5 m 95% of the time. To improve positioning quality to sub-meter levels, the

VS330 is able to use differential corrections received through the internal SBAS demodulator or externally-supplied RTCM corrections.

In addition to these differential services the VS330 can also receive radiobeacon corrections. You can also purchase the VS330 with an RTK rover option, which enables 0.02 m positioning performance when paired with a suitable Hemisphere GPS RTK base receiver product.

For more information on the differential services and the associated commands refer to the Hemisphere GPS Technical Reference (go to www.hemispheregps.com and click the GPS Reference icon).

Automatic SBAS Tracking

The VS330 automatically scans and tracks SBAS signals without the need to tune the receiver. The VS330 features two-channel tracking that provides an enhanced ability to maintain a lock on an SBAS satellite when more than one satellite is in view. This redundant tracking approach results in more consistent tracking of an SBAS signal in areas where signal blockage of a satellite is possible.

Beacon Operation

Many marine authorities, such as coast guards, have installed networks of radiobeacons that broadcast DGPS corrections to users of this system. With the increasing utility of these networks for terrestrial applications, there is an increasing trend toward densification of these networks inland. The dual channel beacon receiver in the VS330 can operate in manual or automatic tuning mode, or, using database mode, will select the closest station in compliance with IEC 61108-4 standards.

RTK

Real time kinematic (RTK) technology is available on Eclipse-based GNSS receivers. RTK requires the use of two separate receivers: a stationary base station (primary receiver) that broadcasts corrections over a wireless link to the rover (secondary receiver). The localized corrections are processed on the rover to achieve superior accuracy and repeatability. Performance testing has shown positioning accuracy at the centimeter level.

L-Band

L-band DGNSS (VBS/HP/XP/G2) corrections are available worldwide through third-party providers. With this service, the positioning accuracy does not degrade as a function of distance to a base station, as the data content is not composed of a single base station's information, but an entire network's information.

VS330 Overview

The VS330 provides accurate and reliable heading and position information at high update rates. To accomplish this task, the VS330 uses a high performance GNSS receiver and two antennas for GNSS signal processing. One antenna is designated as the primary GNSS antenna and the other is the secondary GNSS antenna. Positions computed by the VS330 are referenced to the phase center of the primary GNSS antenna. Heading data references the vector formed from the primary GNSS antenna phase center to the secondary GNSS antenna phase center.

Fixed Baseline Moving Base Station RTK

The VS330's internal GNSS receiver uses both the L1/L2 GNSS C/A code and carrier phase data to compute the location of the secondary GNSS antenna in relation to the primary GNSS antenna with a very high sub-centimeter level of precision. The technique of computing the location of the secondary GNSS antenna with respect to the primary antenna, when the primary antenna is moving, is often referred to as moving base station real time kinematic (or moving base station RTK).

Generally, RTK technology is very sophisticated and requires a significant number of possible solutions to be analyzed where various combinations of integer numbers of L1/L2 wavelengths to each satellite intersect within a certain search volume. The integer number of wavelengths is often referred to as the "ambiguity" as they are initially ambiguous at the start of the RTK solution.

The VS330 restricts the RTK solution by knowing that the secondary GNSS antenna is a fixed distance from the primary GNSS antenna. The default value is 1.0 m, but you may install the antennas with a different separation distance, then enter that value into the VS330. This is called a fixed baseline and it defines the search volume of the secondary antenna as the surface of a sphere with radius 1.0 m centered on the location of the primary antenna (see Figure 2-1).

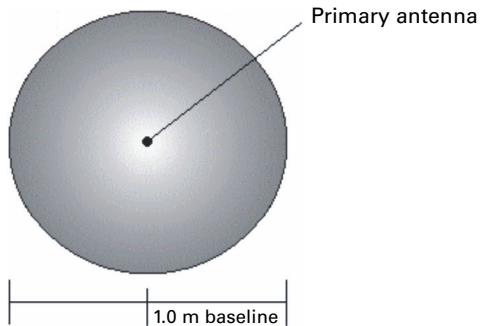

Figure 2-1: Secondary antenna's search volume

Note: The VS330 moving base station algorithm only uses GNSS to calculate heading. Differential and RTK corrections are not used in this calculation and will not affect heading accuracy.

GLONASS

The VS330 is available in its base form as L1/L2 GPS. By adding GLONASS the number of available satellites increases, thereby improving the ability to obtain and maintain a heading solution. For a heading calculation, GPS and GLONASS satellites are used interchangeably, as intersystem biases cancel inside the VS330—this translates into being able to work in more obstructed areas and maintain a GNSS heading solution.

L2 Advantages

Compared to Hemisphere GPS' Crescent Vector technology, Eclipse Vector's dual frequency technology allows for:

- Larger antenna separations
- Longer range RTK
- Faster and more robustly computed GNSS heading solution

Supplemental Sensors

The VS330 has an integrated gyro and two tilt sensors, which are enabled by default. Each supplemental sensor may be individually enabled or disabled. Both supplemental sensors are mounted on the printed circuit board inside the VS330.

The sensors act to reduce the RTK search volume, which improves heading startup and reacquisition times. This improves the reliability and accuracy of selecting the correct heading solution by eliminating other possible, erroneous solutions.

The Hemisphere GPS Technical Reference (go to www.hemispheregps.com and click the GPS Reference icon) describes the commands and methodology required to recalibrate, query, or change the sensors status.

Tilt Aiding

The VS330's accelerometers (internal tilt sensors) are factory calibrated and enabled by default. This constrains the RTK heading solution beyond the volume associated with just a fixed antenna separation. This is because the VS330 knows the approximate inclination of the secondary antenna with respect to the primary antenna. The search space defined by the tilt sensor will be reduced to a horizontal ring on the sphere's surface by reducing the search volume. This considerably decreases startup and reacquisition times (see Figure 2-2).

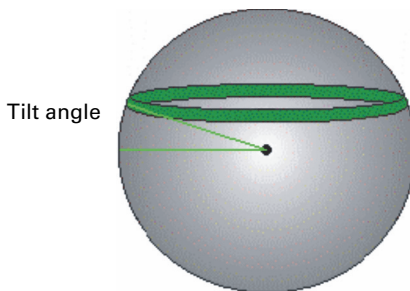

Figure 2-2: VS330's tilt aiding

Gyro Aiding

The VS330's internal gyro offers several benefits. It reduces the sensor volume for an RTK solution. This shortens reacquisition times when a GPS heading is lost because the satellite signals were blocked. The gyro provides a relative change in angle since the last computed heading, and, when used in conjunction with the tilt sensor, defines the search space as a wedge-shaped location (see Figure 2-3).

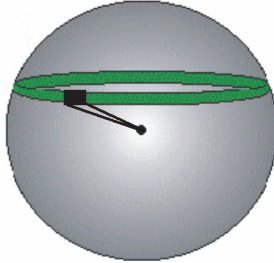

Figure 2-3: VS330's gyro aiding

The gyro aiding accurately smoothes the heading output and the rate of turn. It provides an accurate substitute heading for a short period depending on the roll and pitch of the vessel, ideally seeing the system through to reacquisition. The gyro provides an alternate source of heading, accurate to within 1° per minute for up to three minutes, in times of GPS loss for either antenna. If the outage lasts longer than three minutes, the gyro will have drifted too far and the VS330 begins outputting null fields in the heading output messages. There is no user control over the timeout period of the gyro.

The gyro initializes itself at powerup and during initialization, or you can calibrate it as outlined in the Hemisphere GPS Technical Reference (go to www.hemispheregps.com and click the GPS Reference icon). When the gyro is first initializing, it is important that the dynamics that the gyro experiences during this warmup period are similar to the regular operating dynamics. For example, if you use the VS330 on a high speed, maneuverable craft, it is essential that when gyro aiding in the VS330 is first turned on, use it in an environment that has high dynamics for the first five to ten minutes instead of sitting stationary.

With the gyro enabled, the gyro is also used to update the post HTAU smoothed heading output from the moving base station RTK GPS heading computation. This means that if the HTAU value is increased while gyro aiding is enabled, there will be little to no lag in heading output due to vehicle maneuvers. The Hemisphere GPS Technical Reference includes information on setting an appropriate HTAU value for the application.

Time Constants

The VS330 incorporates user-configurable time constants that can provide a degree of smoothing to the heading, pitch, rate of turn (ROT), course over ground (COG), and speed measurements. You can adjust these parameters depending on the expected dynamics of the vessel. For example, increasing the time is reasonable if the vessel is very large and is not able to turn quickly or would not pitch quickly. The resulting values would have reduced "noise," resulting in consistent values with time. However, if the vessel is quick and nimble, increasing this value can create a lag in measurements. Formulas for determining the level of smoothing are located in the

Hemisphere GPS Technical Reference (go to www.hemispheregps.com and click the GPS Reference icon). If you are unsure on how to set this value, it is best to be conservative and leave it at the default setting.

Heading Time Constant

Use the \$JATT,HTAU command to adjust the level of responsiveness of the true heading measurement provided in the \$GPHDT message. The default value of this constant is 0.1 seconds of smoothing when the gyro is enabled. The gyro is enabled by default, but can be turned off. By turning the gyro off, the equivalent default value of the heading time constant would be 0.5 seconds of smoothing. This is not automatically done and therefore you must manually enter it. Increasing the time constant increases the level of heading smoothing and increases lag.

Pitch Time Constant

Use the \$JATT,PTAU command to adjust the level of responsiveness of the pitch measurement provided in the \$PSAT,HPR message. The default value of this constant is 0.5 seconds of smoothing. Increasing the time constant increases the level of pitch smoothing and increases lag.

Rate of Turn (ROT) Time Constant

Use the \$JATT,HRTAU command to adjust the level of responsiveness of the ROT measurement provided in the \$GPROT message. The default value of this constant is 2.0 seconds of smoothing. Increasing the time constant increases the level of ROT smoothing.

Course Over Ground (COG) Time Constant

Use the \$JATT,COGTAU command to adjust the level of responsiveness of the COG measurement provided in the \$GPVTG message. The default value of this constant is 0.0 seconds of smoothing. Increasing the time constant increases the level of COG smoothing. COG is computed using only the primary GPS antenna and its accuracy depends upon the speed of the vessel (noise is proportional to 1/speed). This value is invalid when the vessel is stationary.

Speed Time Constant

Use the \$JATT,SPDTAU command to adjust the level of responsiveness of the speed measurement provided in the \$GPVTG message. The default value of this parameter is 0.0 seconds of smoothing. Increasing the time constant increases the level of speed measurement smoothing.



Chapter 3: Installing the VS330

Mounting the Antennas

Mounting the Receiver

Routing and Connecting the Cables

Connecting the Receiver to External Devices

Default Parameters

Mounting the Antennas

Hemisphere GPS recommends mounting the antennas first then the mounting the receiver. When mounting the antennas consider the following:

- Mounting orientation (parallel or perpendicular)
- Proper antenna placement
- Mounting options (magnetic, pole, or rail mounting)

Antenna Options

The standard VS330 kit does not include antennas. Your VS330 kit may contain a combination of the following antennas: A42, A43, and/or A52. For example:

- If you **will** be using beacon, your kit may include one A43 beacon antenna and one A42 antenna (or one A43 and one A52).
- If you **will not** be using beacon, your kit may include two A42 antennas or two A52 antennas.

Mounting Orientation

The VS330 outputs heading, pitch, and roll readings regardless of the orientation of the antennas. However, the relation of the antennas to the boat's axis determines whether you will need to enter a heading, pitch, or roll bias. The primary antenna is used for positioning and the primary and secondary antennas, working in conjunction, output heading, pitch, and roll values.

Regardless of which mounting orientation you use, the VS330 provides the ability to output the heave of the vessel. This output is available via the \$GPHEV message. For more information on this message refer to the Hemisphere GPS Technical Reference (go to www.hemispheregps.com and click the GPS Reference icon).

Parallel Orientation

The most common installation is to orient the antennas parallel to, and along the centerline of, the axis of the boat. This provides a true heading. In this orientation:

- If you use a gyrocompass, you can enter a heading bias in the VS330 to calibrate the physical heading to the true heading of the vessel.
- You may need to adjust the pitch/roll output to calibrate the measurement if the Vector is not installed in a horizontal plane.

Perpendicular Orientation

You can also install the antennas so they are oriented perpendicular to the centerline of the boat's axis. In this orientation:

- You will need to enter a heading bias of +90° if the primary antenna is on the starboard side of the boat and -90° if the primary antenna is on the port side of the boat.
- You will need to configure the receiver to specify the GPS antennas are measuring the roll axis using \$JATT,ROLL,YES.
- You will need to enter a roll bias to properly output the pitch and roll values.
- You may need to adjust the pitch/roll output to calibrate the measurement if the Vector is not installed in a horizontal plane.

Planning the Optimal Antenna Placement

Note: In the VS330 kit, install the A42 or A52 antenna as the primary antenna as it is used for positioning.

Proper antenna placement is critical to positioning accuracy. For the best results, orient the antennas so the antennas' connectors face the same direction. Also, place the antennas:

- With a clear view of the horizon
- Away from other electronics and antennas
- Along the vessel's centerline

⚠ WARNING: You must install the primary antenna along the vessel's centerline; you cannot adjust the position readings if the primary antenna is installed off the centerline. Positions are computed for the primary antenna.

- On a level plane
- With a 10.0 m maximum separation (default is 1.0 m)
- Away from radio frequencies
- As high as possible

Set the MSEP value to be accurate to within 1 to 2 cm. For more information on MSEP refer to the Hemisphere GPS Technical Reference (go to www.hemispheregps.com and click the GPS Reference icon).

See Figure 3-1 below through Figure 3-3 on page 16 for mounting orientation examples.

P = primary antenna (A42 or A52)

S = secondary antenna (A42, A52, or A43*)

*must be A43 if using beacon

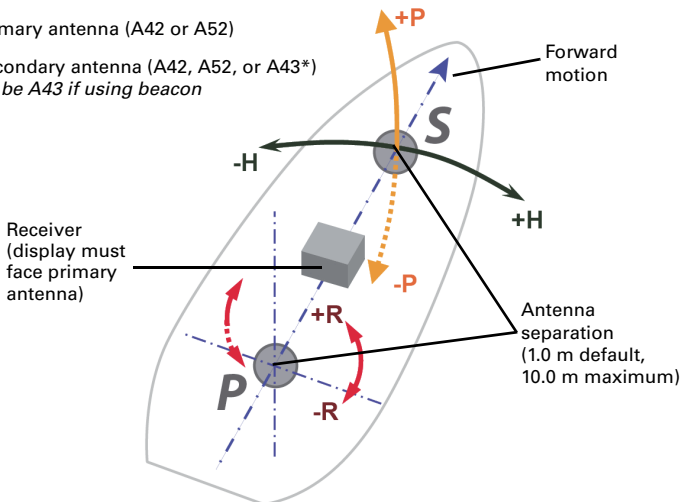

Figure 3-1: Recommended orientation and resulting signs of HPR values

P = primary antenna (A42 or A52)

S = secondary antenna (A42, A52, or A43*)

*must be A43 if using beacon

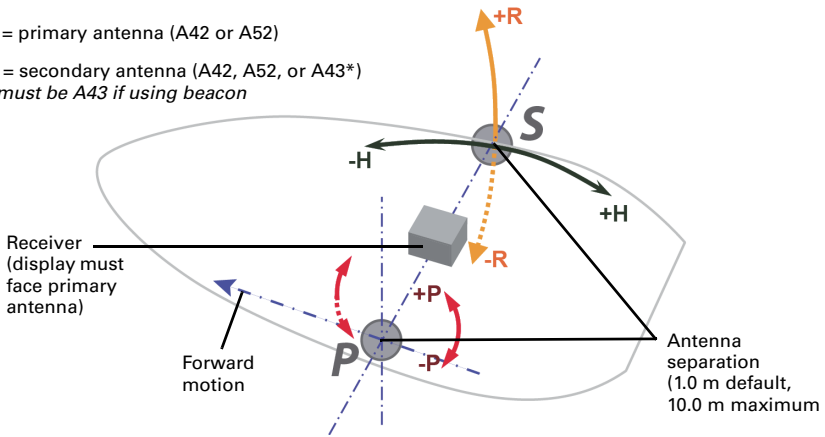

Figure 3-2: Alternate orientation and resulting signs of HPR values

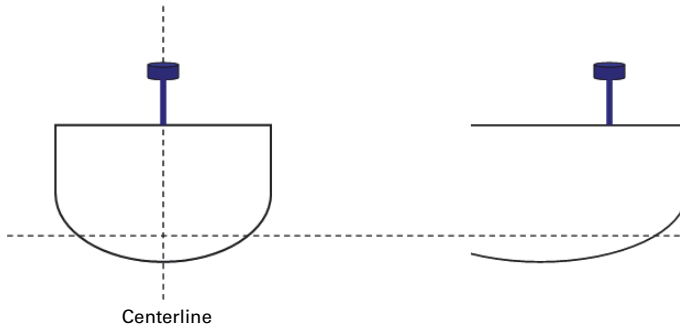

Figure 3-3: Antenna installation: Cross-section of boat

Mounting Options

You can mount the antennas with a magnetic mount, pole mount, or rail mount configuration. You can secure the antennas to a threaded pole or threaded mount using the included mounting adapters.

Depending on the antennas included in your kit, you may need to use the included antenna height adapters to bring the antennas level. If the adapter is not used, you will need to enter a non-level bias calculation into the system (see “Q: I could not install my antennas at the same height. How do I calibrate for the height offset?” on page 47 of Appendix B, “FAQ.”)

⚠ WARNING: The maximum allowable antenna separation is 10.0 m. Any greater distance may result in an incorrect heading.

Magnetic Mount

The following procedure assumes your kit contains one A43 beacon antenna and one A42 antenna. If your kit contains an A52 antenna instead of an A42, follow the same steps. If your kit does not contain an A43 beacon antenna, mount both antennas in the same manner as outlined in the steps for the A42.

Note: Your kit may not include a magnetic mount.

You can screw the magnetic mount into the bottom of the antenna and mount it to any metal surface. If there are no metal surfaces, use the zinc disc and foam adhesive included in your kit to mount the antenna.

To mount the antennas using the magnetic mount:

1. Select a location and orientation that meet the requirements outlined in “Mounting Orientation” on page 14 and “Planning the Optimal Antenna Placement” on page 15.
2. **A42 antenna only:** Unlike the A43, the A42 antenna does not include a threaded mounting hole. You must attach the mounting bracket (see at right) using the four screws in your kit.
3. Attach the magnetic mount extension to the magnetic base plate.



Note: Photos at right and in step 4 show the zinc disc attached to the magnetic base plate. You will only need the zinc disc if mounting the antenna to a non-metal surface (see steps 6 through 11).

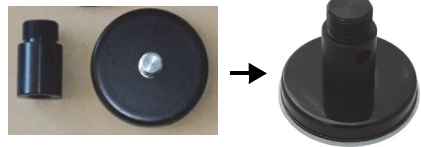

4. Thread the magnetic mount into the mounting bracket on the bottom of the A42 or A52 antenna or into the bottom of the A43 antenna.

⚠ WARNING: When threading the magnetic mounts, hand tighten only. Damage resulting from over-tightening may void your warranty.



A42

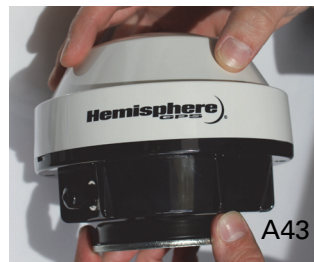

A43

If you are mounting the antenna on a metal surface, go to step 5.

If you are mounting the antenna on a non-metal surface and need to use the metal disc and foam adhesive, skip step 5 and complete steps 6 through 11.

5. Place the antenna in the desired location, ensuring the antenna is secure in its mounting position (end of metal surface mounting procedure).
6. Clean and dry the surface where you will attach the zinc disc.
7. Remove the backing from one side of the foam adhesive and press the adhesive onto the zinc plate (at right).
8. Remove the backing from the other side of the foam adhesive and press the zinc disc onto the mounting surface on the vessel, applying firm pressure to ensure good adhesion.
9. Place the antenna on top of the zinc disc, ensuring the antenna is secure in its mounting position.

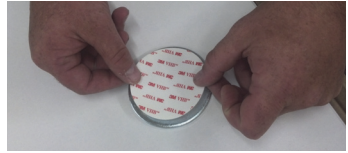

Pole Mount

The following procedure assumes your kit contains one A43 beacon antenna and one A42 antenna. If your kit contains an A52 antenna instead of an A42, follow the same steps. If your kit does not contain an A43 beacon antenna, mount both antennas in the same manner as outlined in the steps for the A42.

You can pole-mount the antennas using existing hardware on your vessel.

To mount the antennas using a pole mount:

1. Select a location and orientation that meet the requirements outlined in "Mounting Orientation" on page 14 and "Planning the Optimal Antenna Placement" on page 15.
2. **A42 antenna only:** Unlike the A43, the A42 antenna does not include a threaded mounting hole. You must attach the mounting base using the four screws included in your kit (see at right).
3. Thread the pole mount (not included) into the mounting bracket on the bottom of the A42 antenna or into the bottom of the A43 antenna.



A42

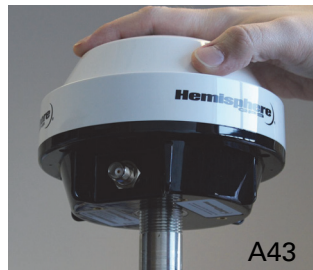

A43

⚠ WARNING: When threading the pole mounts, hand tighten only. Damage resulting from over-tightening may void your warranty.

4. Mark and drill any mounting holes necessary for the pole mounts.

Rail Mount

You can rail mount the antennas using existing hardware on your vessel.

To rail mount the antennas:

1. Select a location and orientation that meet the requirements listed in “Mounting Orientation” on page 14 and “Planning the Optimal Antenna Placement” on page 15.
2. Use appropriate hardware to securely attach the antenna to the railing.

Routing and Securing the Antenna Cable

▲WARNING: The VS330 receiver provides 5 VDC across the antenna ports. Connection to incompatible devices may damage equipment.

To route and secure the antenna cables, review the following guidelines. Each antenna in your kit requires a 50 Ω impedance antenna extension cable, such as RG-58U (up to a maximum of 15 m (49 ft.) in length), for proper operation.

- The GPS receiver inside the VS330 requires a minimum input gain of 10 dB (and maximum of 40 dB before saturation will occur). The antennas offer 28 dB of gain, so the loss budget to accommodate for cable losses is 18 dB.
- Regardless of the cable material and length you choose, ensure the cable losses are less than 18 dB of attenuation. Due to variances in the antenna gain and practical attenuation of cable materials and connectors, Hemisphere GPS recommends reducing this budget to 15 dB; this budget is present to overcome the resulting attenuation of an RF cable.
- When deciding on an antenna location, consider the amount of cable required: a longer cable of the same material will result in a higher loss than a shorter one. If the overall loss of the longer cable exceeds 15 dB, change the cable material (this normally means a more expensive material that has a larger diameter and less flexibility). The standard cables included with the VS330 are of the RG58 material family and their attenuation is ~ 0.8 dB/m. Including connector losses, the nominal loss of these RF cables is ~ 10 dB, which is within the tolerable loss budget. If a 15 m or 20 m cable run is required, a RG8 variety is available. If lengths longer than 20 m are required, more sophisticated materials are required.

For more information on cable length or low-loss cable, contact your dealer or Hemisphere GPS Technical Support. Table 3-1 provides a summary of readily available cable materials with 50 Ω impedance.

Table 3-1: Cable losses (not including connector losses)

Material	Loss at GPS L1 (1.575 GHz)
RG58	0.78 dB/m
RG8	0.36 dB/m
Times Microwave LMR400	0.15 dB/m

For additional cable guidelines see “Routing and Connecting the Cables” on page 21.

Mounting the Receiver

Hemisphere GPS recommends mounting the antennas first and then the mounting the receiver. Use the enclosed kit to mount the receiver. When mounting the VS330 receiver, adhere to the following guidelines:

- Install the receiver inside and away from the elements and in a location that minimizes vibration, shock, extreme temperatures, and moisture
- Position the receiver horizontally with its display facing the primary antenna
- Ensure the front panel (menu screen, LEDs, buttons) is visible and accessible
- Ensure the back panel (ports, connectors) is easily accessible to connect/switch out cables

Figure 3-4 shows the dimensions (including attached mounting brackets) of the VS330. Use Figure 3-4 when using the receiver mounting procedure that follows.

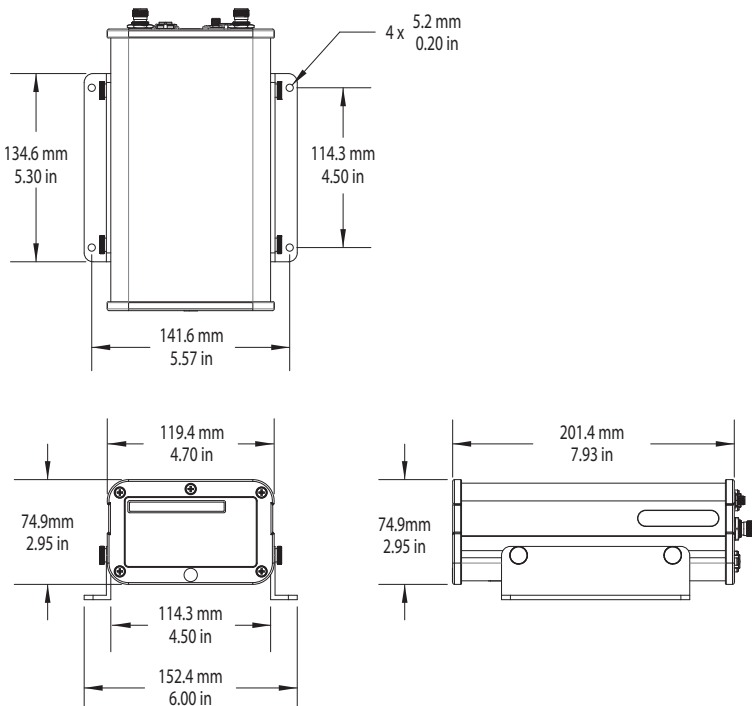

Figure 3-4: VS330 dimensions with mounting brackets

To mount the receiver:

1. Locate the thumbscrews, nuts, and brackets included in your kit.
2. Slide the nuts through the opening (circled at right) along both sides of the receiver.



3. Place the bracket alongside the receiver and insert the thumbscrews (two thumbscrews per bracket) so they screw into the nuts.

4. Using the remaining holes in the brackets (two holes per bracket) screw down the brackets in your preferred location.

Note: Hemisphere GPS does not provide the screws in this step.

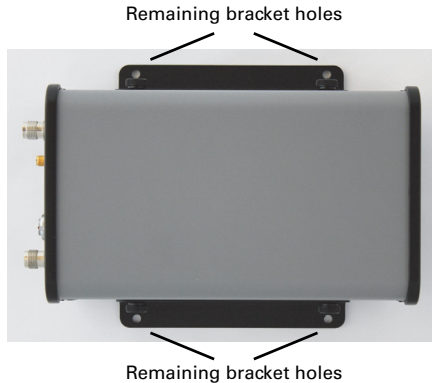

Routing and Connecting the Cables

Adhere to the following when routing and connecting cables:

- Power cable must reach an appropriate power source
- Antenna cables must reach from the antennas to the receiver
- Data cable may connect to a data storage device, computer, or other device that accepts GNSS data
- Do not run cable in areas of excessive heat
- Do not expose cable to corrosive chemicals
- Do not crimp or excessively bend cable
- Do not place tension on cable
- Coil up excess cable near unit
- Secure along the cable route using plastic tie wraps as necessary
- Do not run cable near high voltage or strong RF noise and transmitter sources
- When connecting the power cable to the power source, ensure the power source is between 8 V and 36 V

WARNING: Improperly installed cables near machinery can be dangerous.

Connecting the Receiver to External Devices

You can connect the VS330 to external devices via Port A and Port B on the back of the unit.

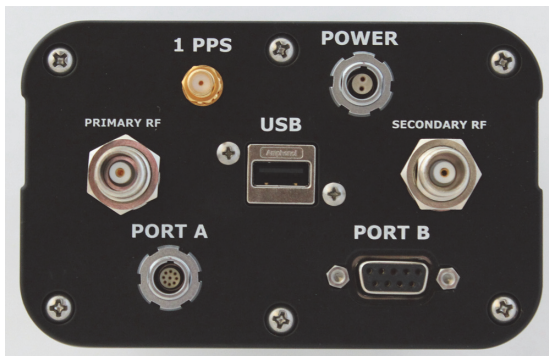

Figure 3-5: VS330 port connections

Figure 3-6 shows the pinout for Port A (ODU 9-pin) and Port B (DB9), and Table 3-2 provides descriptions of the pinouts for each port. Both ports communicate at the RS-232 interface level with external data loggers, navigation systems, and other devices, while Port A can also transmit at the RS-422 level.

The default baud rates, NMEA message types, and update rates for both ports are listed in “Default Parameters” on page 24. If the NMEA data messages you desire are different from the default values, you will need to select those also. Use the Config Wizard to select your NMEA message types and update rates per port (see “Using the Config Wizard” on page 31).

Table 3-2: Port A / Port B pinout descriptions

Pin	Port A	Port B
1	Port A Rx (RS-232)	Not connected
2	Signal ground	Port B Tx (RS-232)
3	Signal ground	Port B Rx (RS-232)
4	1 PPS timing output	Not connected
5	Port A Tx+ (RS-422)	Signal ground
6	Port A Tx- (RS-422)	Not connected
7	Event marker input	Not connected
8	Port A Tx (RS-232)	Not connected
9	Reserved	5V output, 350 mA max

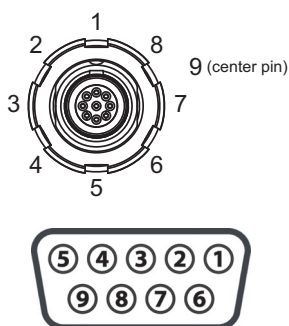

Figure 3-6: Port A (top) and Port B (bottom) pinouts

Figure 3-7 shows the I/O cable that connects to Port A.

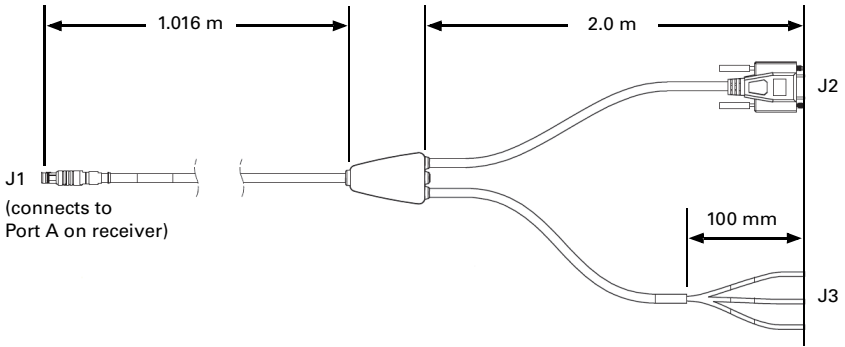

Figure 3-7: I/O cable

Default Parameters

The following represents the standard configuration for the VS330. For more information on these commands refer to the Hemisphere GPS Technical Reference (go to www.hemispheregps.com and click the GPS Reference icon).

Note: Use the \$JSAVE command to save changes you make to the VS330 configuration for the changes to be present in subsequent power cycles. Also, if you change any default values and then issue a \$JRESET command verify your settings to make sure you consistently get a correct heading. To reset the VS330 to its default parameters you can re-install the configuration file (shown below)—contact your dealer or Hemisphere GPS Technical Support for information on obtaining and re-installing the configuration file.

```

$JOFF, PORTA
$JOFF, PORTB
$JOFF, PORTD

$JAGE, 2700
$JLIMIT, 10
$JMASK, 5
$JNP, 5
$JWAASPRN, AUTO
$JDIFF, WAAS
$JPOS, 51.0, -114.0
$JSMOOTH, LONG
$JTAU, COG, 0.00
$JTAU, SPEED, 0.00
$JAIR, AUTO
$JALT, NEVER

$JATT, ACC180, YES
$JRELAY, PORTC, $MENUOPTIONS, ACC180, ON, TRUE
$JATT, HTAU, 0.1
$JATT, HRTAU, 2.0
$JATT, COGTAU, 0.0
$JATT, MSEP, 1.0
$JATT, GYROAID, YES
$JATT, TILTAID, YES
$JATT, LEVEL, NO
$JATT, EXACT, NO
$JATT, HIGHMP, YES
$JATT, FLIPBRD, YES
$JATT, HBIAS, 0.0
$JATT, NEGILT, NO
$JATT, NMEAHE, 0
$JATT, PBIAS, 0.0
$JATT, PTAU, 0.5
$JATT, ROLL, NO
$JATT, SPDTAU, 0.0
$JASC, ROX, 0, PORTD

$JBAUD, 19200, PORTA
$JASC, GPGGA, 1, PORTA
$JASC, GPHDT, 10, PORTA
$JASC, GPROT, 10, PORTA
$JASC, GPHPR, 1, PORTA

$JBAUD, 19200, PORTB
$JASC, GPGGA, 1, PORTB
$JASC, GPHDT, 10, PORTB
$JASC, GPROT, 10, PORTB
$JASC, GPHPR, 1, PORTB

$JSAVE

```



Chapter 4: Operating the VS330

Powering the Receiver On/Off

LED Indicators

Startup

Using the Menus

Configuring the VS330

Disabling the Aiding Features

Adjusting the Time Constants

Connecting to Existing Navigation Systems

Viewing GNSS/DGPS Status

USB Data Logging

Powering the Receiver On/Off

The power button on the VS330 is located on the front panel (circled below). When you first apply power to the unit it turns on.



Figure 4-1: VS330 front panel with power button

The VS330 accepts an input voltage of 8 to 36 VDC via the power cable. The supplied power should be continuous and clean for best performance. Table D-5 on page 59 provides the power specifications of the VS330.

WARNING: Do not apply a voltage higher than 36 VDC. This will damage the receiver and void the warranty. Also, do not attempt to operate the VS330 with the fuse bypassed as this will void the warranty.

The VS330 features reverse polarity protection to prevent damage if the power leads are accidentally reversed. Although the VS330 proceeds through an internal startup sequence when you apply power, it will be ready to communicate immediately.

Initial startup may take 5 to 15 minutes depending on the location. Subsequent startups will output a valid position within 1 to 5 minutes depending on the location and time since the last startup.

The VS330 may take up to 5 minutes to receive a full ionospheric map from SBAS. Optimum accuracy is obtained once the VS330 is processing corrected positions using complete ionospheric information.

To power on the VS330:

1. Connect the ends of the VS330 power cable to a clean power source providing 8 to 36 VDC.

Note: Hemisphere GPS recommends you use a weather-tight connection and connector if the connection is located outside.

2. Press and hold the soft power switch on the front panel until the splash screen appears.

To power off the VS330:

- Press and hold the soft power switch on the front panel until the screen goes blank.

LED Indicators

The VS330 includes five LEDs located to the left of the display on the front panel (shown at right).

Table 4-1 below describes each LED indicator.



Figure 4-2: VS330 LEDs

Table 4-1: LED indicators

Indicator	Description/Function
HEADING	Valid GNSS heading available Illuminates solid green when the receiver achieves a valid heading solution from the GNSS receiver. You must see PRIM GPS and SEC GPS illuminated before a heading solution is possible. If the GNSS solution is no longer available, the LED turns off.
DIFF	DGPS position indicator Illuminates solid green when the receiver achieves a differential position and a pseudorange residual of better than 10.0 m. If the residual value is worse than the current threshold, the LED blinks green indicating differential mode has been attained but the residual has not met the threshold.
SEC GPS	Secondary antenna is tracking 4 or more satellites Illuminates solid amber when the secondary antenna is tracking four or more satellites.
PRIM GPS	Primary antenna is tracking 4 or more satellites Illuminates solid amber when the primary antenna is tracking four or more satellites.
POWER	Power indicator Illuminates solid red when the receiver is powered on.

Startup

When you power on the VS330 the Hemisphere GPS splash screen appears followed by the main screen, or Top menu (see at top right). Press the Down Arrow button to display the remaining items on the Top menu (see at bottom right).

You use the menus to view and configure system data and settings for the following Top menu items:

- Vector
- GNSS
- Differential (menu item will be the selected differential source, such as SBAS or Autonomous)
- Config Wizard
- System Setup
- Data Logging

For a complete menu path of each Top menu item, see Appendix C, “Menu Map.”

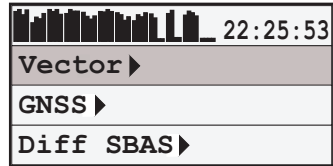

Using the Menus

The VS330 menu system is designed for easy setup and configuration of the unit in or out of the field and supports multiple languages. You can perform most configuration tasks entirely through the menu without having to connect to a computer.

The VS330 front panel contains the three soft buttons shown at right. The Enter button also functions as the power switch (see “Powering the Receiver On/Off” on page 26 for more information).

Table 4-2 describes the indicators to the right of specific menu items.



Up Arrow button - moves to the previous menu item or to the previous selection within a menu item





Enter button - displays a submenu or selects an option within a menu item



Down Arrow button - moves to the next menu item or to the next selection within a menu item

Table 4-2: Menu item indicators

Indicator	Purpose	Example
 Display indicator	<p>Goes to the indicated submenu.</p> <p>This indicator also appears to the right of the “Back” and “Top Menu” menu items.</p> <ul style="list-style-type: none"> Press Enter when “Back” is selected to return to the previous menu. Press Enter when “Top Menu” is selected to return to the Top menu. 	<ol style="list-style-type: none"> On the Top menu press the Down Arrow button to highlight System Setup. The Display indicator appears to the right of System Setup. Press Enter to display the System Setup menu. Press the Down Arrow button again to highlight the Display Format option and then press Enter. The items on the Display Format menu appear and the Select indicator appears to the right of Disp Update (the first item on the Display Format menu).
 Select indicator	<p>Scrolls within a menu to highlight an option to select.</p>	<ol style="list-style-type: none"> Press Enter on the Disp Update item. The Display indicator changes to the Select indicator. Press the Up Arrow or Down Arrow button to scroll through the available options (such as 1Hz and 5Hz). Press Enter on the highlighted option to select it. That option is now the setting for the menu item and the Select indicator changes back to the Display indicator.

To return the menu system to the factory default configuration:

- Press and hold the **Enter** and **Up Arrow** buttons until the splash screen disappears (Enter and Power share the same soft switch).

Configuring the VS330

The Config Wizard menu guides you through various configuration options, enabling you to save up to five different configurations that are useful when using the VS330 on different vessels or for different applications.

If you use a Windows PC or Windows mobile device, you can use Hemisphere GPS' VectorPC software to configure the VS330. See "Using VectorPC to Communicate with the VS330" on page 4 for more information.

Config Wizard Menu

This section describes the basic Config Wizard options you need to set to get up and running. Figure 4-3 outlines the menu structure of the Config Wizard menu.

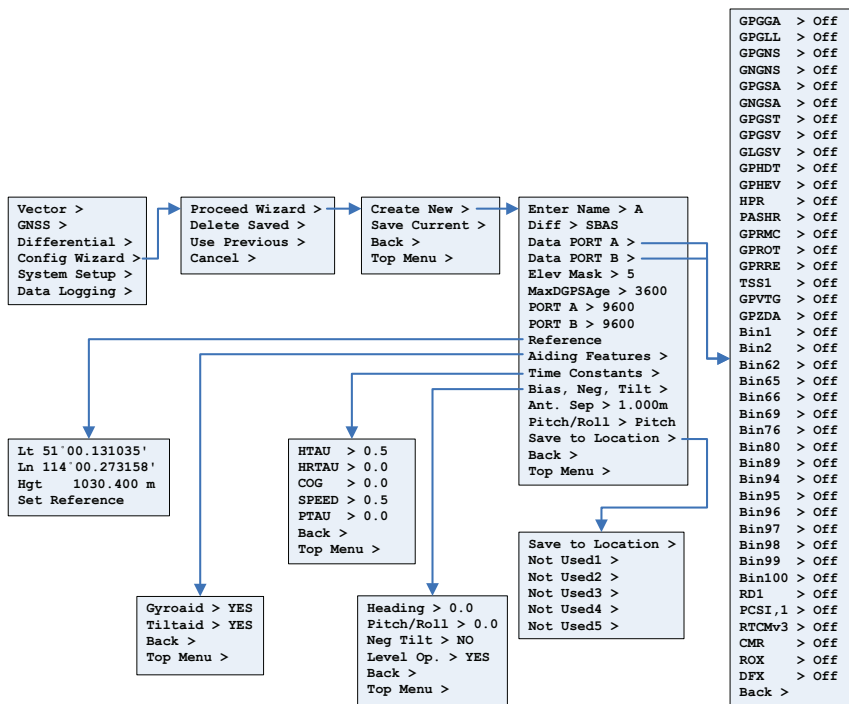

Figure 4-3: Config Wizard menu

Using the Config Wizard

The basic setup instructions outlined in this section assume the antennas are:

- Installed parallel to, and along the centerline of, the vessel's axis
- Separated by 1.0 m

If this is not the case, you will need to enter the actual antenna separation and bias in the Config Wizard.

1. Select **Config Wizard > Proceed Wizard**. The Proceed Wizard menu appears.
2. Select **Create New** to create a new configuration. You are prompted to enter a name for your configuration. In addition to the Name you can set the options shown at right (also shown in Figure 4-3 on the previous page).

```

Enter Name > A
Diff > SBAS
Data PORT A >
Data PORT B >
Elev Mask > 5
MaxDGPSAge > 3600
PORT A > 9600
PORT B > 9600
Reference
Aiding Features >
Time Constants >
Bias, Neg, Tilt >
Ant. Sep > 1.000m
Pitch/Roll > Pitch
Save to Location >
Back >
Top Menu >
  
```

Note: For help on using the menus to view and setting values see "Using the Menus" on page 29.

3. *Enter a name:*
 - a. Use the arrow buttons to select a character and then press the **Enter** button to save the character. The cursor moves to the right.
 - b. Repeat step a for each additional character in the name.
 - c. Scroll through the list of characters until you reach "┘" and press the **Enter** button to accept the name. You are returned to the previous menu and the name you entered appears next to "Enter Name."

If you are editing an existing name, for characters you want to replace simply select a different character. If the new name is shorter and you need to delete unneeded characters to the right:

- a. After you change the final character in the new name press the **Enter** button repeatedly until the last character is highlighted.
 - b. Scroll through the list of characters until you reach "◀" and press the **Enter** button to delete the character. The cursor moves to the left.
 - c. Repeat step b for each additional rightmost character you want to delete.
 - d. Scroll through the list of characters until you reach "┘" and press the **Enter** button to accept the name. You are returned to the previous menu and the name you entered appears next to "Enter Name."
4. *Set a DGPS source:* From the same menu, select **DIFF**. The options are:
 - SBAS (default)
 - Beacon
 - Autonomous
 - RTK
 - L-Band
 - Extern RTCM (External RTCM)

5. *Change the type of GPS data message sent to the data ports:* Select either **Data Port A** or **Data Port B** from the menu list.
6. *Set the elevation cutoff angle:* Select **Elev Mask** and set the angle between 0° and 45°. The default value is 5°.
7. *Set the maximum DGPS age:* The maximum DGPS age is 2700 seconds (45 minutes) by default.
8. *Configure baud rates:* If the default baud rate on the selected port does not match that of the external device you are connecting to, you will need to configure the Baud Rate, using the Port A or Port B entries. 4800, 9600, 19200, 38400, 57600, and 115200 are the available baud rates.
9. *Enable/disable aiding features:* The Aiding Features menu enables you to turn the gyroaid and tiltaid features on or off. For more information on disabling the aiding features, see “Disabling Tilt Aiding” on page 33 or “Disabling Gyro Aiding” on page 33.
10. *Adjust time constants:* While the default time constants settings will work for most users, if you have a large, slow turning vessel or a small, quick moving vessel you may want to adjust the time constants to reduce heading start up and re acquisition times.
For details on configuring the time constants, see “Adjusting the Time Constants” on page 34.
11. *Enter a heading bias:* If you did not install the antenna’s parallel to and along the vessel’s centerline, you will need to enter a heading bias in the Heading field of the Bias, Neg, Tilt menu. The heading bias (-180° to +180°) compensates for any offset from the centerline.

Note: If you installed the antennas for roll (perpendicular to the boat’s axis), rather than pitch, you must enter the heading bias (+/-90°). You must also enter the bias for roll (see below).

12. *Enter a pitch/roll bias:* Enter the bias for pitch or roll (-15° - +15°) to compensate for any offset from the boat’s centerline. Enter this bias in the Pitch/Roll field of the Bias, Neg, Tilt menu.
13. *Enter the antenna separation:* If you did not install the antennas 1.0 m apart, enter the actual antenna separation in the Ant. Sep field. The available range is 0 - 10.0 m.
14. *Configure antenna for roll:* Most users install the antennas for pitch; however, if you install the antennas for roll, you will need to configure the VS330 for roll. In the Create New menu set the Pitch/Roll setting to Roll.
15. *Save your configuration:* To save your new configuration, select the Save to Location field. You will be prompted for a location to save your configuration.

Select one of the empty slots, noted by the name Not Used or select a slot with an existing configuration to overwrite it.

After your configuration is saved, you must select it from the Config Wizard in order to activate it. You may then continue to enter different receiver configurations without upsetting the current operation of the receiver. Re-enter the Config Wizard and select the configuration to use.

Disabling the Aiding Features

While the default settings will work for most users, you can configure the tilt and gyro aiding features to further reduce heading startup and re-acquisition times.

Disabling Tilt Aiding

The VS330's tiltaid (accelerometer) is enabled by default and constrains the RTK heading solution to reduce startup and re acquisition times. The tiltaid is precalibrated at the factory; however, if you experience any tilt measurement offset, you can recalibrate the tilt sensor via the Calibrate Tilt option in the Vector menu. See "Vector menu" on page 50 for a menu map on how to access this feature.

Note: Make sure the receiver is perfectly level before recalibrating the tiltaid.

The only times you may need to disable the tiltaid feature are:

- If you were unable to install the VS330 on a level plane with the antennas. The tilt sensor is located inside the VS330, so it is important that you install the VS330 on a level horizontal plane.

⚠ WARNING: If you were unable to install the VS330 in a horizontal plane with the antennas, you must disable tiltaid. Failure to do so may cause erratic equipment behavior.

- If troubleshooting, to ensure the receiver is working properly.

You can turn tilt aiding off either through the Config Wizard or Vector menus.

Disabling Gyro Aiding

The VS330's internal gyro-aid is enabled by default. The gyro:

- Shortens re-acquisition times when satellites are obstructed and heading is lost, by reducing the search volume required for the RTK solution, and
- Provides accurate substitute headings for a short period (depending on the roll and pitch of the vessel) ideally seeing you through to re-acquisition.

The only time you might need to disable the gyro-aid is during troubleshooting, to ensure the receiver is working properly.

⚠ WARNING: Do not exceed turn rates of 90°/sec. The VS330 uses gyro measurements to obtain a heading rate measurement and the gyro cannot measure beyond this rate.

You can turn the gyroaid feature off either through the Config Wizard menu or the Vector menu.

Adjusting the Time Constants

The VS330's default settings are fine for most users; however, you can set the time constants to further smooth heading, course-over-ground (COG), and speed measurements. Table 4-3 provides an overview of the time constant values you can set in the Config Wizard, including the formulas for finding the optimal value of each time constant for your vessel.

Table 4-3: Time constants

Time Constant	Description
COGTAU (Course Over Ground)	<p>Adjust the responsiveness to the course over ground measurement. If vessel is small and dynamic, leave this value at 0.0 s to be conservative. If the vessel is large and resistant to motion, you may want to increase this value.</p> <p>Default value: 0.0 s Range: 0.0 to 60 s</p> <p>Formula: $\text{cogtau (s)} = 10 / \text{max rate of change of course (}^\circ/\text{sec)}$</p>
HRTAU (Rate of Turn)	<p>Adjust the responsiveness to the rate of heading change. If vessel is large and unable to turn quickly, you may want to increase this value.</p> <p>Default value: 2.0 s with gyro enabled Range: 0.0 to 60 s</p> <p>Formula: $\text{hrtau (s)} = 10 / \text{max rate of the rate of turn (}^\circ/\text{s}^2)$</p>
HTAU (Heading)	<p>Adjust the responsiveness to true heading. If vessel is large and unable to turn quickly, you may want to increase this value.</p> <p>For longer baselines (10 m) HTAU should be between 0.1 and 0.5, since the gyro introduces noise.</p> <p>Default value: 0.1 s with gyro enabled Range: 0.0 to 60 s</p> <p>Formula: $\text{htau (s)} = 40 / \text{max rate of turn (}^\circ/\text{s)}$ <i>with gyro ON</i> $\text{htau (s)} = 10 / \text{max rate of turn (}^\circ/\text{s)}$ <i>with gyro OFF</i></p>
PTAU (Pitch)	<p>Adjust the responsiveness to pitch. If vessel is large and unable to pitch quickly, may want to increase this value.</p> <p>Default value: 0.5 s Range: 0.0 to 60 s</p> <p>Formula: $\text{ptau (s)} = 10 / \text{max rate of pitch (}^\circ/\text{s)}$</p>
SPDTAU (Speed)	<p>Adjust the responsiveness to speed. If vessel is small and dynamic, leave this value at 0.0 s to be conservative. If the vessel is large and resistant to motion, you may want to increase this value.</p> <p>Default value: 0.0 s Range: 0.0 to 60 s</p> <p>Formula: $\text{spdtau (s)} = 10 / \text{max acceleration (m/s}^2)$</p>

Connecting to Existing Navigation Systems

Most users connect the VS330 to their existing navigation system during installation. These users will receive the VS330's position and heading updates through the interface of their existing system.

Viewing GNSS/DGPS Status

Most users will receive position and heading information through their on-board navigation system. If you have not connected the VS330 to an existing navigation system, or are troubleshooting your unit, you may need to view GNSS, DGPS, or beacon status on the VS330's display screen.

Do I Have a Signal?

Figure 4-2 on page 27 shows which LEDs on the VS330 will indicate GNSS, DGPS or Beacon signal lock when illuminated. If you lose the differential signal lock, Hemisphere GPS COAST technology allows the VS330 to perform well for 40 minutes or more with aging differential GNSS correction data. The amount of time you can "coast" depends on the degree of tolerable drift.

Note: To obtain a full set of SBAS corrections, the VS330 must receive the ionospheric map over a period of a few minutes. After this, the receiver can "coast" until the next set of corrections has been received.

How Good is the Quality of My Signal?

In addition to the LED indicators for signal lock, the VS330's display indicates signal quality. The bars along the top of the display represent the quality of the GNSS and DGPS (or if applicable, beacon) signal. The first group of bars shows the GPS signal; the second group shows the DGPS or beacon signal. Each bar represents a distinct channel and its associated signal quality. The higher the bar, the better the signal.

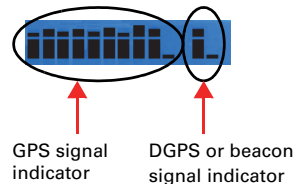

Note: If using autonomous or external correction mode, the DGPS signal indicator will not appear in the display.

DGPS (SBAS)

The differential correction (or SBAS) signal indicator reflects the quality of each satellite signal, or the bit error rate (BER). A full bar height reflects a signal lock and a BER of 0. A bar height only 2 pixels tall reflects a signal loss, or BER, of 500 or greater. Bar heights in between reflect intermediate degrees of signal quality. For example, when using WAAS two satellites are available, so two BERs are provided.

Beacon

The beacon indicator reflects the quality of the beacon signal, or the signal strength (SS) and the signal-to-noise ratio (SNR). A full bar height reflects a signal lock, $SS \geq 35$, and $SNR \geq 24$. A bar height only 2 pixels tall reflects a signal loss, or SS and SNR values of 0. Bar heights in between reflect intermediate degrees of signal quality. If using beacon, the first bar indicates SS signal quality; the second bar indicates SNR signal quality.

USB Data Logging

When you insert a USB flash drive into the VS330, the Data Logging menu indicates you can start recording (logging data) and displays the free space on the flash drive (see Figure 4-4). When you start logging data the “Start Recording” indicator changes to “End <filename>”.

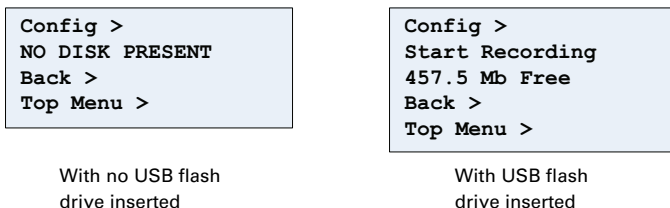

Figure 4-4: USB flash drive indicators on Data Logging menu

⚠ WARNING: Stop data logging before removing the USB flash drive from the VS330. Failure to do so may result in a loss of data.

Selecting the Data File Type and Log Options

You can log the following data types to a USB flash drive:

- RAW - binary, NMEA, and other data options (see Table 4-4)
- KML - Google Earth KML format with latitude, longitude and height
- CSV - comma-separated value (CSV) format with time, latitude, longitude, and height
- PostPro - VS330 automatically turns on the appropriate messages for post processing
- debug - VS330 logs high speed data for troubleshooting purposes (contact Hemisphere GPS Technical Support for more information)

Table 4-4: RAW data log options

Format	Description
Raw (binary)	For raw (binary) data logging, you may also want the receiver configuration to be inserted into the file. If you select this option the file will start with the receiver configuration comprised of the replies to the \$JI, \$JK, \$JT, and \$JSHOW queries.
NMEA	National Marine Electronics Association (NMEA 0183) - industry standard data transmission format
CMR	Proprietary data correction format
DFX	Hemisphere GPS-proprietary data correction format
ROX	Hemisphere GPS-proprietary data correction format
RTCM	Radio Technical Commission for Maritime Services - industry standard data correction format

To select a data logging type:

1. Select **Data Logging > Config > FileType**.
2. Press the **Up/Down Arrow** buttons until your preferred data type appears then press **Enter**.

When logging using the RAW data type (File Type > RAW as shown in Figure 4-5) you can select which data to log and at what rate by selecting Data Logs and then making the desired selections on the Data Logs menu.

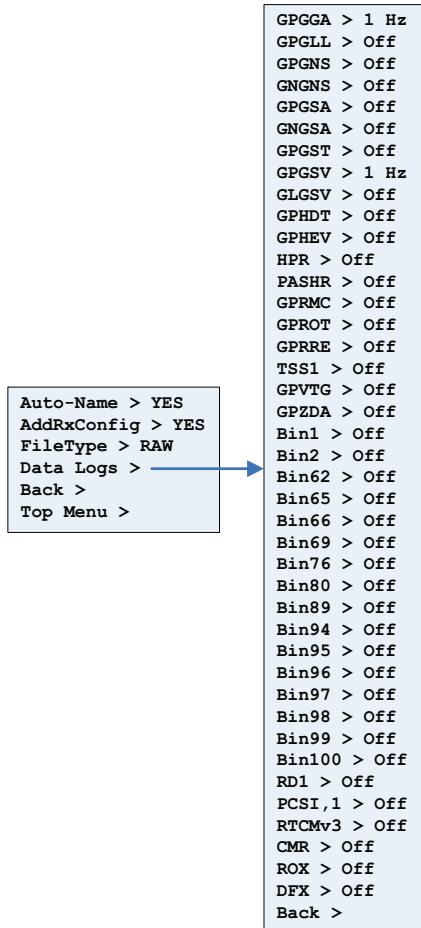

Figure 4-5: Data Logging > Config > Data Logs menu

*Note: Logged data options are limited by your receiver subscriptions (certain options may not appear on the Data Logs menu without a specific subscription). For example, GNGNS, GNGSA, GLGSV, Bin62, Bin65, Bin66, and Bin69 only appear on the Data Logs menu if you are authorized to receive GLONASS. To view your subscriptions press **System Setup > Software Disp > Authorizations**.*

Logging Data to a File

You can log data to a file that the VS330 auto-generates or you can manually enter a filename to which to log data. You can append data to or overwrite data on a manually-named file; however, you cannot append data to or overwrite data on an VS330-generated file.

To log data to an VS330 auto-generate filename:

1. Select **Data Logging > Config**.
2. If Auto-Name displays No select **Auto-Name** and then press **Enter**.
3. Select **Yes** and then press **Enter**.
4. Select **Back** to return to the Data Logging menu.
5. Select **Start Recording** to begin logging data. The Start Recording option changes to End <filename>.
6. Select **End <filename>**.

To log data to a manually-created filename:

1. Select **Data Logging > Config**.
2. If Auto-Name displays Yes select **Auto-Name** and then press **Enter**.
3. Select **No** and press **Enter**. The Enter Name and Mode menu items appear below Auto-Name.
4. Enter a filename:
 - a. Select **Enter Name** and press **Enter**.
 - b. Enter the desired characters for the filename and then scroll to the return character and press **Enter**.
5. Select the mode:
 - a. Select **Mode** and press **Enter**.
 - b. Select **Append** to log data to new file or to append data to an existing file (based on the filename in step 4) and press **Enter**.

or

Select **Overwrite** to overwrite an existing file (based on the filename in step 4) and press **Enter**.

▲WARNING: No warnings are given to confirm overwriting a previous file.

6. Select **Back** to return to the Data Logging menu.
7. Select **Start Recording** to begin logging data. The Start Recording option changes to End <filename>.
8. Select **End <filename>**.

Data Post-Processing

After you log data you can then process the data with a Receiver Independent Exchange (RINEX) format software utility. Hemisphere GPS Rinex conversion software is available from the Hemisphere GPS website at www.hemispheregps.com.

Make sure you select PostPro as the file type before logging the data you will use for post processing (see “Selecting the Data File Type and Log Options” on page 36).

To post-process raw data:

1. Log the raw data to the USB flash drive inserted in the VS330. Make sure you properly end your data logging before removing the flash drive in step 2 below.
2. Remove the flash drive from the VS330 then insert the drive in a PC with Hemisphere GPS' Rinex conversion software installed.
3. Run the Rinex conversion software.



Appendix A: Troubleshooting

Table A-1 provides troubleshooting for common problems.

Table A-1: Troubleshooting

Symptom	Possible Solution
Receiver fails to power	<ul style="list-style-type: none"> • Verify polarity of power leads • Check integrity of power cable connectors • Check power input voltage (8 to 36 VDC) • Check current restrictions imposed by power source (minimum available should be > 1.0 A)
No data from VS330	<ul style="list-style-type: none"> • Check receiver power status to ensure the receiver is powered (an ammeter can be used for this) • Verify desired messages are activated (using VectorPC or \$JSHOW in any terminal program) • Ensure the baud rate of the VS330 matches that of the receiving device • Check integrity and connectivity of power and data cable connections
Random data from VS330	<ul style="list-style-type: none"> • Verify the RTCM or binary messages are not being output accidentally (send a \$JSHOW command) • Ensure the baud rate of the VS330 matches that of the remote device • Potentially, the volume of data requested to be output by the VS330 could be higher than the current baud rate supports (try using 19200 as the baud rate for all devices or reduce the amount of data being output)
No GPS lock	<ul style="list-style-type: none"> • Verify the VS330 has a clear view of the sky • Verify the lock status of GPS satellites (this can be done with VectorPC)
No beacon lock	<ul style="list-style-type: none"> • Verify the receiver is tuned to the correct frequency and bit rate • Ensure beacon signal coverage is expected in your area • Ensure environmental noise is not masking the signal, reducing the SNR reading
No SBAS lock	<ul style="list-style-type: none"> • Verify the VS330 has a clear view of the sky • Verify the lock status of SBAS satellites (this can be done with VectorPC - monitor BER value) • Set SBAS mode to automatic with the \$JWAASPRN,AUTO command <p>SBAS lock is only possible if you are in an appropriate SBAS region; currently, there is limited SBAS availability in the southern hemisphere.</p>

Table A-1: Troubleshooting (continued)

Symptom	Possible Solution
No heading or incorrect heading value	<ul style="list-style-type: none"> • Check CSEP value is fairly constant without varying more than 1 cm (0.39 in)—larger variations may indicate a high multipath environment and require moving the receiver location <p>The standard antenna mounting configuration provides a 0.5° heading accuracy at 95% confidence. If you require more performance, you will need to increase the antenna separation (maximum recommended separation is 10.0 m). See Table D-1 on page 58 for antenna separation specifications.</p> <ul style="list-style-type: none"> • Recalibrate the tilt sensor with \$JATT,TILTCAL command if heading is calculated then lost at consistent time intervals • Heading is from primary GPS antenna to secondary GPS antenna • \$JATT,SEARCH command forces the VS330 to acquire a new heading solution (unless gyro is enabled) • Enable GYROAID to provide heading for up to three minutes during GPS signal loss • Enable TILTAID to reduce heading search times • Monitor the number of satellites and SNR values for both antennas within VectorPC—at least four satellites should have strong SNR values • Potentially, the volume of data requested to be output by the VS330 could be higher than the current baud rate supports (try using 19200 as the baud rate for all devices or reduce the amount of data being output)
No DGPS position in external RTCM mode	<ul style="list-style-type: none"> • Verify the baud rate of the RTCM input port matches the baud rate of the external source • Verify the pinout between the RTCM source and the RTCM input port (transmit from the source must go to receive of the RTCM input port and grounds must be connected) • Ensure corrections are being transmitted to the correct port—using the \$JDIF,PORTB command on Port A will cause the receiver to expect the corrections to be input through Port B



Appendix B: FAQ

This appendix covers power, communication and external RTCM questions. For GPS and Heading troubleshooting, see Chapter 4, "Operating the VS330."

Q: Can COAST technology work with corrections from an external source?

A: Yes, the VS330 will operate in a similar fashion with COAST technology as when using SBAS or Beacon corrections. However, SBAS corrections have the advantage that they are separated into separate error components, allowing the VS330 to anticipate how errors will change over the coasting period with more consistent accuracy and for a longer period than regular RTCM range corrections.

Q: My VS330 does not appear to be communicating. What do I do?

A: This could be one of the following issues:

- Examine the power cable and its connector for signs of damage.
- Ensure you are properly powering the system with the correct voltage (8 to 36 VDC) by measuring the voltage at the receiver end of the power cable when the cable is connected to the power source.
- Check current restrictions imposed by power source (minimum available should be > 1.0 A).
- Verify the display has turned on and that time is incrementing in the upper right corner of the display, and configure the COM port baud rates appropriately through the menu system.
- Verify polarity of power leads.
- Check the 1.0 A inline power cable fuse.
- Since you are required to terminate the power input with your choice of connector, ensure you have made a good connection to the power supply.
- Consult the troubleshooting section of the other device's reference manual to determine if there is an issue with that device.

Q: Am I able to configure the two serial ports with different baud rates?

A: Yes, the ports are independent. For example, you may have one port set to 4800 and the other to 19200 or vice versa.

Q: Am I able to have the VS330 output different NMEA messages through the two ports?

A: Yes, you may have different NMEA messages turned on for the two serial ports. Further, these NMEA messages may also be at different update rates.

Q: How do I determine the current configuration of the VS330?

A: You can view the current configuration from various screens of the menu, which show all configurable items of the receiver. Alternately, you can select **Config Wizard > Use Previous** to return the receiver to a previously saved (known) configuration.

Q: My VS330 does not appear to be using corrections from an external correction source. What could be the problem?

A: This could be due to a number of issues. Check the following items.

- Make sure the corrections are of an RTCM SC-104 protocol.
- Verify the baud rates of the port used by the VS330 match that of the external correction source.

- The external correction source should be using an 8 data bit, no parity, 1 stop bit (8-N-1) serial port configuration.
- Inspect the cable connection to ensure there are no signs of damage.
- Check the pinout information for the cables to ensure the transmit line of the external correction source is connected to the receive line of the VS330's serial port and that the signal grounds are connected.

Save the configuration as the profile named "RTCM" in the Config Wizard, cycle the power and load the RTCM profile.

Q: Why am I not getting data from the VS330?

A: There are several possible reasons for this. Check the following items.

- Check receiver power status LED to ensure the receiver is powered.
- Verify the VS330 is locked to a valid DGPS signal (this can often be done on the receiving device or with VectorPC).
- Verify the VS330 is locked to GPS satellites (this can often be done on the receiving device or with VectorPC).
- Check the integrity and connectivity of power and data cable connections.

Q: Why am I getting random data from VS330?

A: There are three possible reasons for this. Check the following items.

- Verify the RTCM or the Bin95 and Bin96 messages are not being output accidentally (send a \$JSHOW command).
- Verify the baud rate settings of VS330 and remote device match correctly.
- Potentially, the volume of data requested to be output by the VS330 could be higher than the current baud rate supports. Try increasing the baud rate to 38400 for all devices or reduce the amount of data being output.

Q: I could not install my antennas at the same height. How do I calibrate for the height offset?

A: You may enter a non-level bias calculation that adjusts the pitch/roll output to calibrate the measurement if the antenna array is not installed on a horizontal plane.

To calibrate the pitch/roll reading, send the following command:

```
$JATT,PBIAS,x<CR><LF>
```

where x is a bias (in degrees) that will be added to the pitch/roll measurement. The acceptable pitch bias range is -15.0° to 15.0° (default is 0.0°).

To determine the current pitch compensation angle, send the following command:

```
$JATT,PBIAS<CR><LF>
```

The pitch/roll bias is added after the negation of the pitch/roll measurement (if so invoked with the \$JATT,NEGILT command).



Appendix C: Menu Map

Vector Menu
GNSS Menu
Differential Menu
Config Wizard Menu
System Setup Menu
Data Logging Menu

This appendix shows the complete menu map for each menu (listed below) on the VS330 Top menu:

- Vector
- GNSS
- Differential (menu item will be the selected differential source, such as SBAS or Autonomous)
- Config Wizard
- System Setup
- Data Logging

Vector Menu

Use the Vector menu to view and adjust Vector settings. Options vary depending on whether you select Pitch or Roll and include such items as aiding features, time constants, heading bias, and antenna separation.

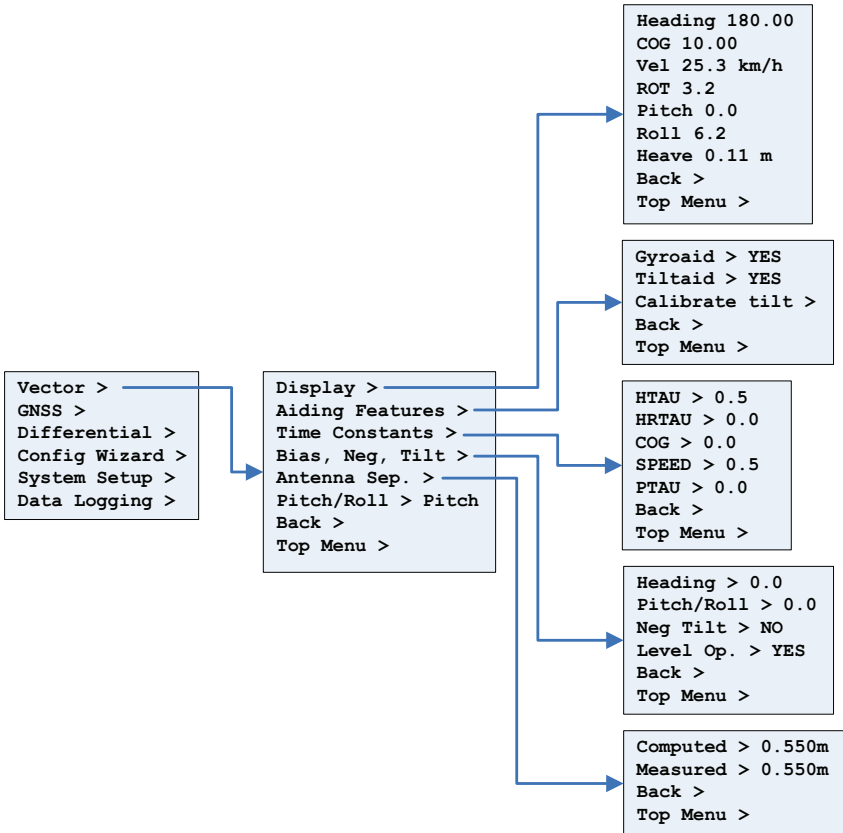

Figure C-1: Vector menu

GNSS Menu

Use the GNSS menu to view and edit your GNSS settings. Settings include the data port outputs, specific positioning parameters, UTC time offset, and satellite visibility and positioning information.

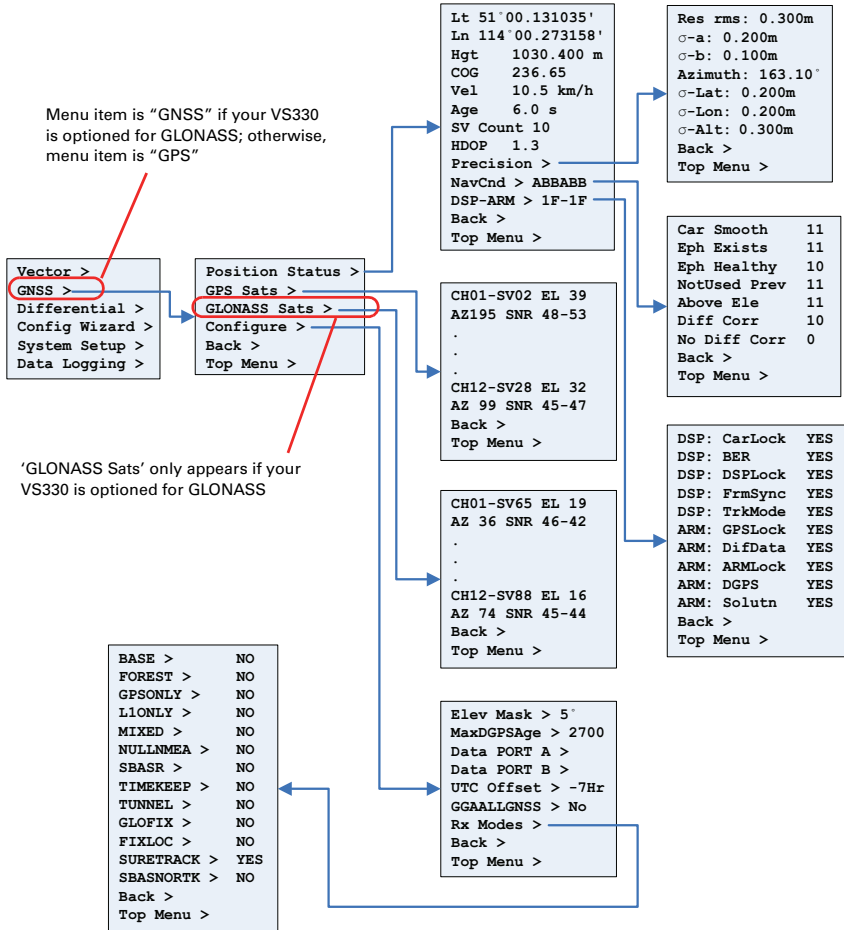

Figure C-2: GNSS menu

Differential Menu

Use the Differential menu to view or change your differential settings. The following available differential sources depend on the configuration you purchased.

- SBAS
- Beacon (RTCM2) - available with purchased unlock code
- RTK (CMR, ROX, RTCM3)
- L-band (OMNIVBS, OMNIHP) - available with purchased unlock code
- None (Autonomous)

To select the differential source:

1. Press **Differential > Include** then set each format you may use to **Yes**. For example, if you will be using Beacon, set RTCM2 to Yes.
2. Press **Back** to return to the previous menu level, press **InUse**, then select your preferred differential source. For example, if you will be using Beacon, select Beacon (RTCM2 will be displayed when finished).

Figure C-3 through Figure C-7 show the complete menu maps for the SBAS, Beacon, RTK, L-band, and Autonomous, respectively. The Include menu (at right) in each of these figures shows all available formats. If you have not purchased unlock codes for L-band and Beacon, the OMNIVBS/OMNIHP (L-band) and RTCM2 (Beacon) menu items will not appear on your menu.

SBAS >	YES
OMNIVBS >	YES
OMNIHP >	YES
RTCM2 >	YES
DFX >	NO
CMR >	NO
RTCM3 >	NO
ROX >	NO
Back >	
Top Menu >	

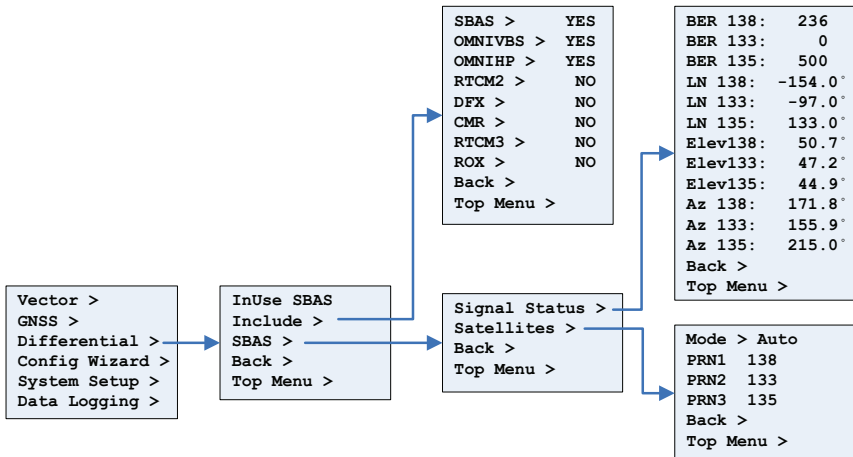

Figure C-3: SBAS menu

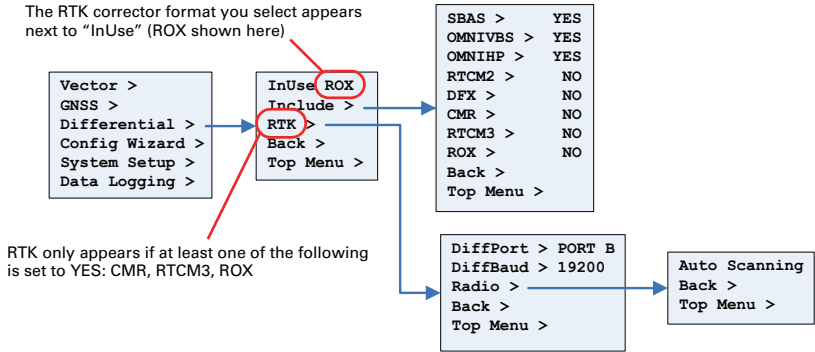

Figure C-4: RTK menu

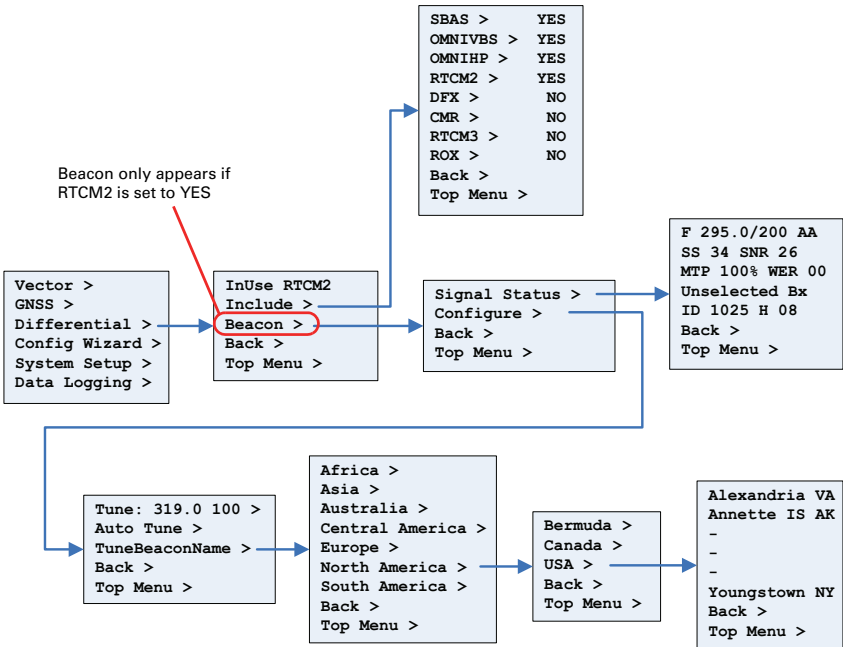

Figure C-5: Beacon menu

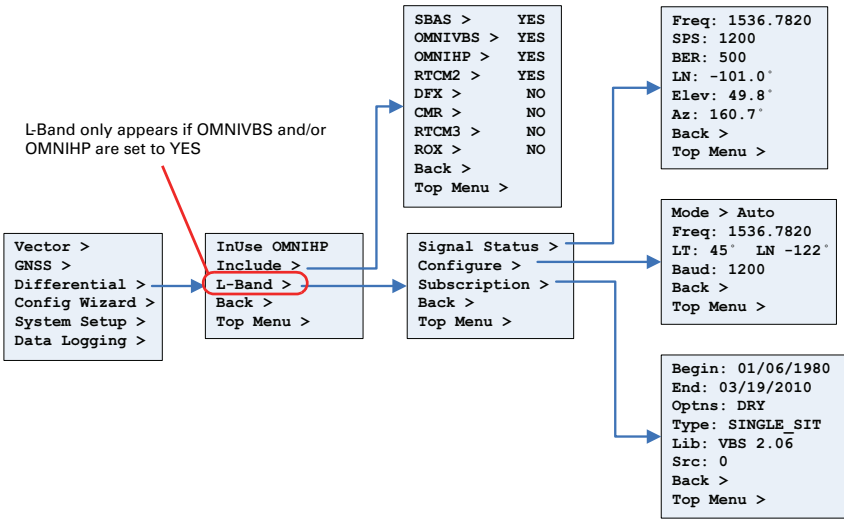

Figure C-6: L-band menu

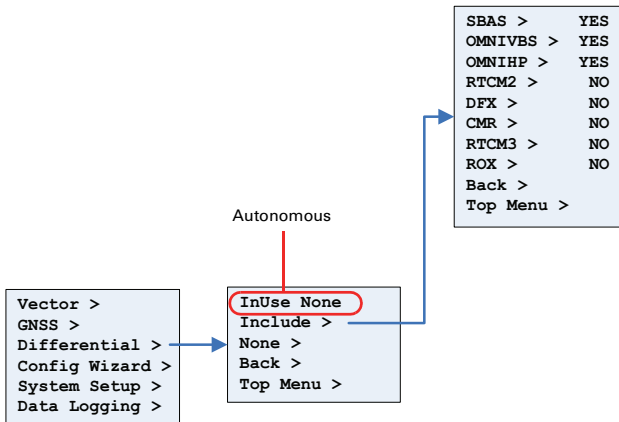

Figure C-7: Autonomous menu

Config Wizard Menu

The Config Wizard walks you through basic settings to get up and running. See “Configuration Wizard” on page 27 to view the Config Wizard menu map.

System Setup Menu

The System Setup menu allows you quickly view and edit current system settings. General settings include such items as current applications, units, baud rates, logs, LED contrast, subscription code, display orientation (you can flip the display 180° by selecting *YES* under *Flip Display*), and language.

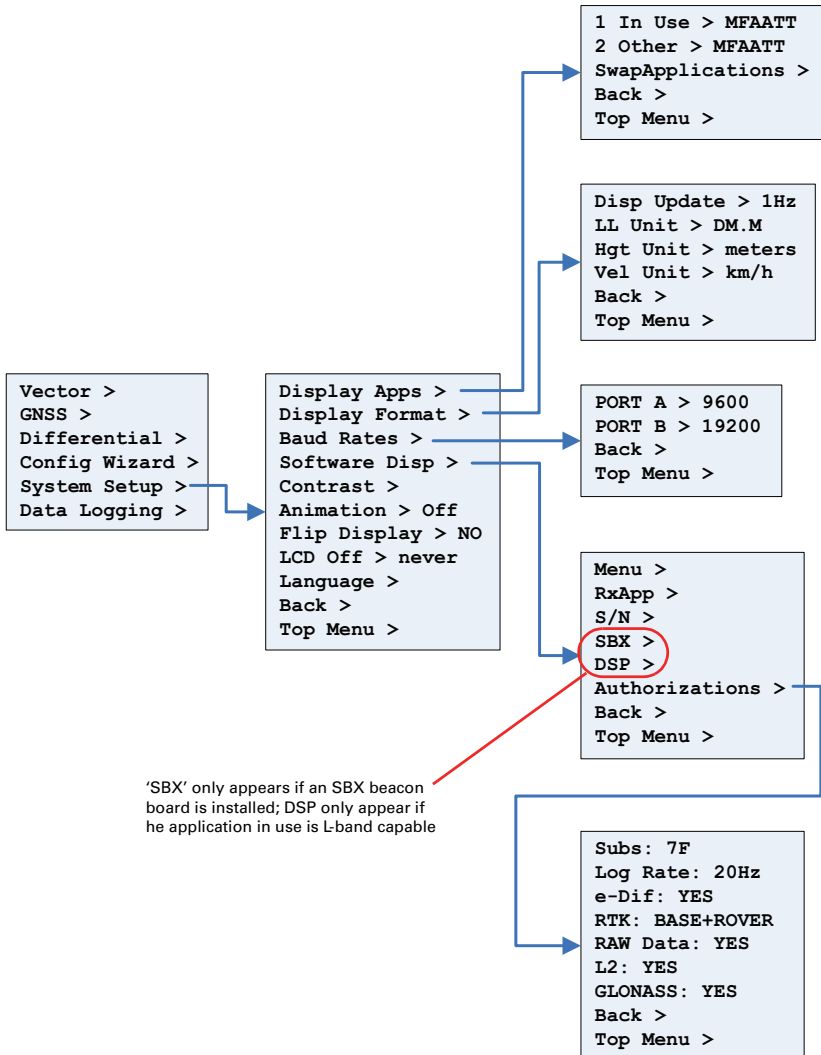

Figure C-8: System Setup menu

Data Logging Menu

The Data Logging menu allows you to log or output job data, view USB flash drive free storage space, set up file auto-naming, and view what type of data you are logging.

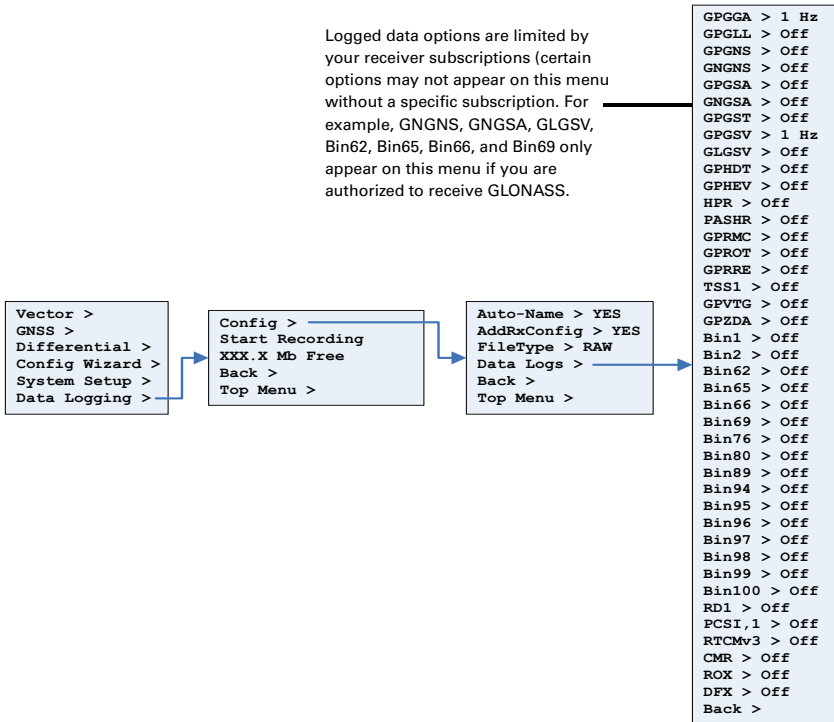

Figure C-9: Data Logging menu



Appendix D: Technical Specifications

VS330 Receiver Specifications

A42 Antenna Specifications

A43 Antenna Specifications

A52 Antenna Specifications

VS330 Receiver Specifications

Table D-1 through Table D-8 list the technical specifications of the VS330.

Table D-1: VS330 GNSS sensor specifications

Item	Specification																		
Receiver type	Vector GNSS L1/L2 RTK																		
Signals received	GPS, GLONASS, Galileo ¹																		
Channels	Two 270-channel																		
GPS sensitivity	-142 dBm																		
SBAS tracking	3-channel, parallel tracking																		
Update rate	10 Hz standard, 20 Hz available by subscription																		
Horizontal accuracy	<table border="0"> <tr> <td></td> <td>RMS (67%)</td> <td>2DRMS (95%)</td> </tr> <tr> <td>RTK²</td> <td>10 mm + 1 ppm</td> <td>20 mm + 2 ppm</td> </tr> <tr> <td>L-band DGNSS (VBS/HP/XP/G2)^{3,4}</td> <td>0.08 m</td> <td>0.16 m</td> </tr> <tr> <td>SBAS (WAAS)³</td> <td>0.25 m</td> <td>0.50 m</td> </tr> <tr> <td>Beacon³</td> <td>0.25 m</td> <td>0.50 m</td> </tr> <tr> <td>Autonomous, no SA³</td> <td>1.2 m</td> <td>2.5 m</td> </tr> </table>		RMS (67%)	2DRMS (95%)	RTK ²	10 mm + 1 ppm	20 mm + 2 ppm	L-band DGNSS (VBS/HP/XP/G2) ^{3,4}	0.08 m	0.16 m	SBAS (WAAS) ³	0.25 m	0.50 m	Beacon ³	0.25 m	0.50 m	Autonomous, no SA ³	1.2 m	2.5 m
	RMS (67%)	2DRMS (95%)																	
RTK ²	10 mm + 1 ppm	20 mm + 2 ppm																	
L-band DGNSS (VBS/HP/XP/G2) ^{3,4}	0.08 m	0.16 m																	
SBAS (WAAS) ³	0.25 m	0.50 m																	
Beacon ³	0.25 m	0.50 m																	
Autonomous, no SA ³	1.2 m	2.5 m																	
Heading accuracy	<p>< 0.17° rms @ 0.5 m antenna separation</p> <p>< 0.09° rms @ 1.0 m antenna separation</p> <p>< 0.04° rms @ 2.0 m antenna separation</p> <p>< 0.02° rms @ 5.0 m antenna separation</p> <p>< 0.01° rms @ 10.0 m antenna separation</p>																		
Pitch/roll accuracy	< 1° rms																		
Heave accuracy	30 cm (DGPS), 10 cm (RTK) ⁵																		
Timing (1PPS) accuracy	20 ns																		
Rate of turn	90°/s maximum																		
Cold start time	< 40 s typical (no almanac or RTC)																		
Warm start time	< 20 s typical (almanac and RTC)																		
Hot start time	< 5 s (almanac, RTC, and position)																		
Heading fix	< 10 s typical (valid position)																		
Maximum speed	1,850 kph (999 kts)																		
Maximum altitude	18,288 m (60,000 ft)																		

Table D-2: VS330 beacon sensor specifications

Item	Specification
Channels	2-channel, parallel tracking
Frequency range	283.5 to 325 kHz
Operating modes	Manual, automatic, and database
Compliance	IEC 61108-4 beacon standard

Table D-3: VS330 L-band sensor specifications

Item	Specification
Sensitivity	-130 dBm
Channel spacing	7.5 kHz
Satellite selection	Manual and automatic
Reacquisition time	15 seconds (typical)
Rejection	15 kHz spacing > 30 dB 300 kHz spacing > 60 dB
Processor	DSP for demodulation and protocol decoding module provides processing for differential algorithms
Command support	Reports L-band region and satellite information Allows input and status of L-band subscription, bit error rate (BER) output for reception quality indication, and manual frequency tuning

Table D-4: VS330 communication specifications

Item	Specification
Serial ports	2 full-duplex RS-232, 1 full-duplex RS-422
USB ports	1 USB-A
Baud rates	4800 - 115200
Data I/O protocol	NMEA 0183, Crescent binary ⁶
Correction I/O protocol	RTCM v2.3 (DGPS), RTCM v3 (RTK), CMR (RTK), CMR+ (RTK) ⁷
Timing output	1 PPS CMOS, active high, rising edge sync, 10 k Ω , 10 pF load

Table D-5: VS330 power specifications

Item	Specification
Power input voltage	8 to 36 VDC
Power consumption	< 6.2 W nominal (GNSS L1/L2 L-band) < 5.3 W nominal (GNSS L1/L2 RTK)
Current consumption	< 0.52 A nominal (GNSS L1/L2 L-band) < 0.44 A nominal (GNSS L1/L2 RTK)
Power isolation	500 V
Reverse polarity protection	Yes
Antenna short circuit protection	Yes
Antenna input impedance	50 Ω

Table D-6: VS330 environmental specifications

Item	Specification
Operating temperature	-30°C to +70°C (-22°F to +158°F)
Storage temperature	-40°C to +85°C (-40°F to +185°F)

Table D-6: VS330 environmental specifications (continued)

Item	Specification
Humidity	95%, non-condensing
Enclosure rating	IP66 (IEC 60529)
Shock and vibration	Mechanical Shock: EP455 Section 5.14.1 Vibration: EP455 Section 5.15.1 Random
EMC	CE (IEC 60945 Emissions and Immunity), FCC Part 15, Subpart B, CISPR 22
IMO wheelmarked certification	No

Table D-7: VS330 mechanical specifications

Item	Specification
Dimensions	20.2 L x 12.0 W x 7.5 H (cm) 8.0 L x 4.7 W x 3.0 H (in)
Weight	~1.1 kg (2.5 lb)
Status indications (LEDs)	Power, primary GPS lock, secondary GPS lock, differential lock, DGPS position, heading, RTK lock, L-band lock
Power switch	Front panel soft switch
Power connector	2-pin ODU metal circular
Data connectors	(1) DB9 sealed (1) 9-pin ODU metal circular
Antenna connectors	(2) TNC female

Table D-8: Aiding devices

Item	Specification
Gyro	Provides smooth heading, fast heading reacquisition and reliable < 1° per minute heading for periods up to 3 minutes when loss of GPS has occurred. ⁸
Tilt sensors	Provide pitch, roll data and assist in fast start-up and reacquisition of heading solution.

¹Upgrade required

²Depends on multipath environment, number of satellites in view, satellite geometry, baseline length (for local services), and ionospheric activity

³Depends on multipath environment, number of satellites in view, and satellite geometry

⁴Requires a subscription from L-band service provider

⁵Based on a 40 second time constant

⁶Hemisphere GPS proprietary

⁷Receive only, does not transmit this format

⁸Under static conditions

A42 Antenna Specifications

Table D-9 through Table D-12 list the technical specifications of the A42 antenna.

Table D-9: A42 GNSS sensor specifications

Specification	Description
GNSS reception	GPS L1/L2/L5, GLONASS L1/L2, Beidou, SBAS, L-band DGNSS (VBS/HP/XP/G2), and Galileo E1/E5a and b
GNSS frequency	1.165 to 1.253 GHz 1.525 to 1.613 GHz
LNA gain	30 dB
LNA noise	2.0 dB, typical

Table D-10: A42 power specifications

Specification	Description
Input voltage	3.3 to 12 VDC
Input current	35 mA, typical

Table D-11: A42 mechanical specifications

Specification	Description
Enclosure	Aluminum base with ASA plastic cap
Dimensions	7.0 H x 13.0 D (cm) 2.9 H x 5.1 D (in)
Weight	0.38 kg (0.84 lb)
Mount	5/8" female thread
RF connector	TNC straight

Table D-12: A42 environmental specifications

Specification	Description
Operating temperature	-40°C to +70°C (-40°F to +158°F)
Storage temperature	-40°C to +85°C (-40°F to +185°F)
Enclosure rating	IP69K
Shock and vibration	EP455

A43 Antenna Specifications

Table D-13 through Table D-18 list the technical specifications of the A43 antenna.

Table D-13: A43 GNSS sensor specifications

Specification	Description
GNSS reception	GPS L1/L2/L5, GLONASS L1/L2, BeiDou, SBAS, L-band DGNSS (VBS/HP/XP/G2), and Galileo E1/E5a and b
GNSS frequency	1.165 to 1.253 GHz 1.525 to 1.613 GHz
LNA gain	30 dB
LNA noise	2.0 dB, typical

Table D-14: A43 L-band sensor specifications

Specification	Description
L-Band frequency	1.525 - 1.585 GHz
L-Band LNA gain	30 dB

Table D-15: A43 beacon sensor specifications

Specification	Description
Beacon frequency	283.5 - 325 kHz
Beacon LNA gain	30 dB

Table D-16: A43 power specifications

Specification	Description
Input voltage	5 to 12 VDC
Input current	40 - 50 mA, typical

Table D-17: A43 mechanical specifications

Specification	Description
Enclosure	Lexan
Dimensions	10.4 H x 14.5 D (cm) 4.1 H x 5.7 D (in)
Weight	0.73 kg (1.6 lb)
Mount	1" coarse thread (5/8" adapter available)
Connector	TNC

Table D-18: A43 environmental specifications

Specification	Description
Storage temperature	-40°C to +85°C (-40°F to +185°F)
Operating temperature	-40°C to +70°C (-40°F to +158°F)
Enclosure rating	IP69K
Shock and vibration	EP 455

A52 Antenna Specifications

Table D-9 through Table D-12 list the technical specifications of the A52 antenna.

Table D-19: A42 GNSS sensor specifications

Specification	Description
GNSS reception	GPS L1/L2/L5, GLONASS L1/L2, BeiDou, SBAS, L-band DGNSS (VBS/HP/XP/G2), and Galileo E1/E5a and b
GNSS frequency	1.165 to 1.253 GHz 1.525 to 1.613 GHz
LNA gain	30 dB
LNA noise	2.0 dB, typical

Table D-20: A42 power specifications

Specification	Description
Input voltage	3.3 to 12 VDC
Input current	35 mA, typical

Table D-21: A42 mechanical specifications

Specification	Description
Enclosure	Aluminum base with ASA plastic cap
Dimensions	7.6 H x 18.5 D (cm) 3.0 H x 7.3 D (in)
Weight	0.78 kg (1.71 lb)
Mount	5/8" female thread
RF connector	TNC straight or right angle

Table D-22: A42 environmental specifications

Specification	Description
Operating temperature	-40°C to +70°C (-40°F to +158°F)
Storage temperature	-40°C to +85°C (-40°F to +185°F)
Enclosure rating	IP69K
Shock and vibration	EP455

Note: The phase center variation is less than 3 mm at GPS L1 and L2 for elevations above 15 degrees

Index

Numerics

1 PPS output 22

A

A43 antenna
 beacon sensor specifications 62
accelerometer *See* tilt aid
antenna
 cable, routing and securing 19
 mounting 16
 mounting, magnetic 17
 mounting, pole mount 18
 mounting, rail mount 19
 placement, optimal 15
 primary, search volume 8
 secondary 8

B

base station, moving, RTK 8
baud rate 46
beacon
 A43 sensor specifications 62
 description of 7
 sensor specifications 58
 status 35

C

cables
 antenna 19
 connecting 21
CMR (RAW data option) 36
COAST
 corrections from external source 46
communication specifications 59
configuration
 menu system 29
 of the system 30
 returning to factory defaults 29
 wizard 30, 54
 wizard, using 31
CSV data format 36

D

data logging
 overview 36
 post-processing 39
DFX (RAW data option) 36
DGPS
 status 35
DGPS position indicator LED 27

Diff (differential source)
 menu map 52
disabling
 gyro 33
 tilt aid 33

E

environmental
 A42 specifications 61
 A43 specifications 63
 A52 specifications 64
environmental specifications 59
event marker 22

G

GNSS sensor
 A42 specifications 61
 A43 specifications 62
 A52 specifications 64
GPS
 menu map 51
 operation 6
 receiver performance 6
 specifications 58
gyro 33
 aiding 10
 calibration, self or manual 10
 disabling 33

H

heading 14, 35
 bias 14
heading rate time constant 11
HRTAU 11

K

KML data format 36

L

L-Dif
 and RTK 7
LED
 DGPS position indicator 27
 indicators 27
 power indicator 27
logging data to a file (instructions) 38

M

mechanical
 A42 specifications 61

- A43 specifications 62
- A52 specifications 64
- menu map 28
 - Diff (differential source) 52
 - GPS 50, 51
 - SBAS 52
 - system setup 55
 - vector 50
- mounting *See* antenna mounting

N

- NMEA (RAW data option) 36
- NMEA messages 46

P

- position 35
- post-processing data 39
- power
 - A42 specifications 61
 - A43 specifications 62
 - A52 specifications 64
 - powering up the system 26
 - specifications 59
- power indicator LED 27
- powering off the receiver 26
- powering on the receiver 26

R

- RAW data format 36
- receiver
 - logging data 36
 - powering off 26
 - powering on 26
- receiver, mounting 20
- ROX (RAW data option) 36
- RTCM (RAW data option) 36
- RTK
 - and L-Dif 7
 - constrained heading solution 33
 - moving base station 8
 - use by VS330 8

S

- SBAS
 - coasting between corrections 35
 - not available 6
 - receiving corrections 35
 - tracking 7
 - use of 6
- setup, system, menu map 55
- signal
 - indicators 35
 - lock 35
 - lock, LED readout 35
 - quality 35

- specifications
 - A42 environmental 61
 - A42 GNSS sensor 61
 - A42 mechanical 61
 - A42 power 61
 - A43 beacon sensor 62
 - A43 environmental 63
 - A43 GNSS sensor 62
 - A43 mechanical 62
 - A43 power 62
 - A52 environmental 64
 - A52 GNSS sensor 64
 - A52 mechanical 64
 - A52 power 64
 - beacon sensor 58
 - communication 59
 - environmental 59
 - GPS 58
 - power 59
 - receiver 58

T

- tilt aid, disabling 33
- time constants 34
 - adjusting 34
 - course-over-ground 11
 - heading 11
 - HRTAU 11
 - speed 11
- tracking, automatic 6
- turn rate, limits 33

U

- updates, receiving 35
- USB data logging 36

V

- vector, menu map 50

W

- wizard
 - configuration 30, 54
 - configuration, using 31

End User License Agreement

IMPORTANT - This is an agreement (the "**Agreement**") between you, the end purchaser ("**Licensee**") and Hemisphere GNSS Inc. ("**Hemisphere**") which permits Licensee to use the Hemisphere software (the "**Software**") that accompanies this Agreement. This Software may be licensed on a standalone basis or may be embedded in a Product. Please read and ensure that you understand this Agreement before installing or using the Software Update or using a Product.

In this agreement any product that has Software embedded in it at the time of sale to the Licensee shall be referred to as a "**Product**". As well, in this Agreement, the use of a Product shall be deemed to be use of the Software which is embedded in the Product.

BY INSTALLING OR USING THE SOFTWARE UPDATE OR THE PRODUCT, LICENSEE THEREBY AGREES TO BE LEGALLY BOUND BY THE TERMS OF THIS AGREEMENT. IF YOU DO NOT AGREE TO THESE TERMS, (I) DO NOT INSTALL OR USE THE SOFTWARE, AND (II) IF YOU ARE INSTALLING AN UPDATE TO THE SOFTWARE, DO NOT INSTALL THE UPDATE AND PROMPTLY DESTROY IT.

HEMISPHERE PROVIDES LIMITED WARRANTIES IN RELATION TO THE SOFTWARE. AS WELL, THOSE WHO USE THE EMBEDDED SOFTWARE DO SO AT THEIR OWN RISK. YOU SHOULD UNDERSTAND THE IMPORTANCE OF THESE AND OTHER LIMITATIONS SET OUT IN THIS AGREEMENT BEFORE INSTALLING OR USING THE SOFTWARE OR THE PRODUCT.

1. **LICENSE.** Hemisphere hereby grants to Licensee a non-transferable and non-exclusive license to use the Software as embedded in a Product and all Updates (collectively the "**Software**"), solely in binary executable form.
2. **RESTRICTIONS ON USE.** Licensee agrees that Licensee and its employees will not directly or indirectly, in any manner whatsoever:
 - a. install or use more copies of the Software than the number of copies that have been licensed;
 - b. use or install the Software in connection with any product other than the Product the Software was intended to be used or installed on as set out in the documentation that accompanies the Software.
 - c. copy any of the Software or any written materials for any purpose except as part of Licensee's normal backup processes;
 - d. modify or create derivative works based on the Software;
 - e. sub-license, rent, lease, loan or distribute the Software;
 - f. permit any third party to use the Software;
 - g. use or operate Product for the benefit of any third party in any type of service outsourcing, application service, provider service or service bureau capacity;
 - h. reverse engineer, decompile or disassemble the Software or otherwise reduce it to a human perceivable form;
3. **UPDATES.** At Hemisphere's discretion Hemisphere may make Updates available to Licensee. An update ("**Update**") means any update to the Software that is made available to Licensee including error corrections, enhancements and other modifications. Licensee may access, download and install Updates during the Warranty Period only. All Updates that Licensee downloads, installs or uses shall be deemed to be Software and subject to this Agreement. Hemisphere reserves the right to modify the Product without any obligation to notify, supply or install any improvements or alterations to existing Software.
4. **SUPPORT.** Hemisphere may make available directly or through its authorized dealers telephone and email support for the Software. Contact Hemisphere to find the authorized dealer near you. As well, Hemisphere may make available user and technical documentation regarding the Software. Hemisphere reserves the right to reduce and limit access to such support at any time.
5. **BACKUPS AND RECOVERY.** Licensee shall back-up all data used, created or stored by the Software on a regular basis as necessary to enable proper recovery of the data and related systems and processes in the event of a malfunction in the Software or any loss or corruption of data caused by the Software. Licensee shall assume all risks of loss or damage for any failure to comply with the foregoing.
6. **OWNERSHIP.** Hemisphere and its suppliers own all rights, title and interest in and to the Software and related materials, including all intellectual property rights. The Software is licensed to Licensee, not sold.
7. **TRADEMARKS.** "Hemisphere", "Hemisphere GPS", "Hemisphere GNSS", "Crescent", "Eclipse" and the associated logos are trademarks of Hemisphere. Other trademarks are the property of their respective owners. Licensee may not use any of these trademarks without the consent of their respective owners.
8. **LIMITED WARRANTY.** Hemisphere warrants solely to the Licensee, subject to the exclusions and procedures set forth herein below, that for a period of one (1) year from the original date of purchase of the Product in which it is embedded (the "Warranty Period"), the Software, under normal use and maintenance, will conform in all material respects to the documentation provided with the Software and any media will be free of defects in materials and workmanship. For any Update, Hemisphere warrants, for 90 days from performance or delivery, or for the balance of the original Warranty Period, whichever is greater, that the Update, under normal use and maintenance, will conform in all material respects to the documentation provided with the Update and any media will be free of defects in materials and workmanship. Notwithstanding the foregoing, Hemisphere does not warrant that the Software will meet Licensee's requirements or that its operation will be error free.
9. **WARRANTY EXCLUSIONS.** The warranty set forth in Section (8) will not apply to any deficiencies caused by (a) the Product not being used as described in the documentation supplied to Licensee, (b) the Software having been altered, modified or converted in any way by anyone other than Hemisphere approved by Hemisphere, (c) any malfunction of Licensee's equipment or other software, or (d) damage occurring in transit or due to any accident, abuse, misuse, improper installation, lighting (or other electrical discharge) or neglect other than that caused by Hemisphere. Hemisphere does not warrant or guarantee the precision or accuracy of positions obtained when using the Software (whether standalone or embedded in a Product). The Product and the Software is not intended and should not be used as the primary means of navigation or for use in safety of life applications. The potential

positioning and navigation accuracy obtainable with the Software as stated in the Product or Software documentation serves to provide only an estimate of achievable accuracy based on specifications provided by the US Department of Defense for GPS positioning and DGPS service provider performance specifications, where applicable.

10. **WARRANTY DISCLAIMER.** EXCEPT AS EXPRESSLY SET OUT IN THIS AGREEMENT, HEMISPHERE MAKES NO REPRESENTATION, WARRANTY OR CONDITION OF ANY KIND TO LICENSEE, WHETHER VERBAL OR WRITTEN AND HEREBY DISCLAIMS ALL REPRESENTATIONS, WARRANTIES AND CONDITIONS OF ANY KIND INCLUDING FITNESS FOR A PARTICULAR PURPOSE, MERCHANTABILITY, ACCURACY, RELIABILITY OR THAT THE USE OF THE SOFTWARE WILL BE UNINTERRUPTED OR ERROR-FREE AND HEREBY DISCLAIMS ALL REPRESENTATIONS, WARRANTIES AND CONDITIONS ARISING AS A RESULT OF CUSTOM, USAGE OR TRADE AND THOSE ARISING UNDER STATUTE.
11. **LIMITS ON WARRANTY DISCLAIMER.** Some jurisdictions do not allow the exclusion of implied warranties or conditions, so some of the above exclusions may not apply to Licensee. In that case, any implied warranties or conditions which would then otherwise arise will be limited in duration to ninety (90) days from the date of the license of the Software or the purchase of the Product. The warranties given herein give Licensee specific legal rights and Licensee may have other rights which may vary from jurisdiction to jurisdiction.
12. **CHANGE TO WARRANTY.** No employee or agent of Hemisphere is authorized to change the warranty provided or the limitation or disclaimer of warranty provisions. All such changes will only be effective if pursuant to a separate agreement signed by senior officers of the respective parties.
13. **WARRANTY CLAIM.** In the event Licensee has a warranty claim Licensee must first check for and install all Updates that are made available. The warranty will not otherwise be honored. Proof of purchase may be required. Hemisphere does not honor claims asserted after the end of the Warranty Period.
14. **LICENSEE REMEDIES.** In all cases which involve a failure of the Software to conform in any material respect to the documentation during the Warranty Period or a breach of a warranty, Hemisphere's sole obligation and liability, and Licensee's sole and exclusive remedy, is for Hemisphere, at Hemisphere's option, to (a) repair the Software, (b) replace the Software with software conforming to the documentation, or (c) if Hemisphere is unable, on a reasonable commercial basis, to repair the Software or to replace the Software with conforming software within ninety (90) days, to terminate this Agreement and thereafter Licensee shall cease using the Software. Hemisphere will also issue a refund for the price paid by Licensee less an amount on account of amortization, calculated on a straight-line basis over a deemed useful life of three (3) years.
15. **LIMITATION OF LIABILITY.** IN NO EVENT WILL HEMISPHERE BE LIABLE TO LICENSEE FOR ANY INCIDENTAL, CONSEQUENTIAL, SPECIAL OR INDIRECT DAMAGES INCLUDING ARISING IN RELATION TO ANY LOSS OF DATA, INCOME, REVENUE, GOODWILL OR ANTICIPATED SAVINGS EVEN IF HEMISPHERE HAS BEEN INFORMED OF THE POSSIBILITY OF SUCH LOSS OR DAMAGE. FURTHER, IN NO EVENT WILL HEMISPHERE'S TOTAL CUMULATIVE LIABILITY HEREUNDER, FROM ALL CAUSES OF ACTION OF ANY KIND, EXCEED THE TOTAL AMOUNT PAID BY LICENSEE TO HEMISPHERE TO PURCHASE THE PRODUCT. THIS LIMITATION AND EXCLUSION APPLIES IRRESPECTIVE OF THE CAUSE OF ACTION, INCLUDING BUT NOT LIMITED TO BREACH OF CONTRACT, NEGLIGENCE, STRICT LIABILITY, TORT, BREACH OF WARRANTY, MISREPRESENTATION OR ANY OTHER LEGAL THEORY AND WILL SURVIVE A FUNDAMENTAL BREACH.
16. **LIMITS ON LIMITATION OF LIABILITY.** Some jurisdictions do not allow for the limitation or exclusion of liability for incidental or consequential damages, so the above limitation or exclusion may not apply to Licensee and Licensee may also have other legal rights which may vary from jurisdiction to jurisdiction.
17. **BASIS OF BARGAIN.** Licensee agrees and acknowledges that Hemisphere has set its prices and the parties have entered into this Agreement in reliance on the limited warranties, warranty disclaimers and limitations of liability set forth herein, that the same reflect an agreed-to allocation of risk between the parties (including the risk that a remedy may fail of its essential purpose and cause consequential loss), and that the same forms an essential basis of the bargain between the parties. Licensee agrees and acknowledges that Hemisphere would not have been able to sell the Product at the amount charged on an economic basis without such limitations.
18. **PROPRIETARY RIGHTS INDEMNITY.** Hemisphere shall indemnify, defend and hold harmless Licensee from and against any and all actions, claims, demands, proceedings, liabilities, direct damages, judgments, settlements, fines, penalties, costs and expenses, including royalties and attorneys' fees and related costs, in connection with or arising out of any actual infringement of any third party patent, copyright or other intellectual property right by the Software or by its use, in accordance with this Agreement and documentation, PROVIDED THAT: (a) Hemisphere has the right to assume full control over any action, claim, demand or proceeding, (b) Licensee shall promptly notify Hemisphere of any such action, claim, demand, or proceeding, and (c) Licensee shall give Hemisphere such reasonable assistance and tangible material as is reasonably available to Licensee for the defense of the action, claim, demand or proceeding. Licensee shall not settle or compromise any of same for which Hemisphere has agreed to assume responsibility without Hemisphere's prior written consent. Licensee may, at its sole cost and expense, retain separate counsel from the counsel utilized or retained by Hemisphere.
19. **INFRINGEMENT.** If use of the Software may be enjoined due to a claim of infringement by a third party then, at its sole discretion and expense, Hemisphere may do one of the following: (a) negotiate a license or other agreement so that the Product is no longer subject to such a potential claim, (b) modify the Product so that it becomes non-infringing, provided such modification can be accomplished without materially affecting the performance and functionality of the Product, (c) replace the Software, or the Product, with non-infringing software, or product, of equal or better performance and quality, or (d) if none of the foregoing can be done on a commercially reasonable basis, terminate this license and Licensee shall stop using the Product and Hemisphere shall refund the price paid by Licensee less an amount on account of amortization, calculated on a straight-line basis over a deemed useful life of three (3) years.
The foregoing sets out the entire liability of Hemisphere and the sole obligations of Hemisphere to Licensee in respect of any claim that the Software or its use infringes any third party rights.
20. **INDEMNIFICATION.** Except in relation to an infringement action, Licensee shall indemnify and hold Hemisphere harmless from any and all claims, damages, losses, liabilities, costs and expenses (including reasonable fees of lawyers and other professionals) arising out of or in connection with Licensee's use of the Product, whether direct or indirect, including without limiting the foregoing, loss of data, loss of profit or business interruption.

21. **TERMINATION.** Licensee may terminate this Agreement at any time without cause. Hemisphere may terminate this Agreement on 30 days notice to Licensee if Licensee fails to materially comply with each provision of this Agreement unless such default is cured within the 30 days. Any such termination by a party shall be in addition to and without prejudice to such rights and remedies as may be available, including injunction and other equitable remedies. Upon receipt by Licensee of written notice of termination from Hemisphere or termination by Licensee, Licensee shall at the end of any notice period (a) cease using the Software; and (b) return to Hemisphere (or destroy and provide a certificate of a Senior Officer attesting to such destruction) the Software and all related material and any magnetic or optical media provided to Licensee. The provisions of Sections 6), 7), 8), 9), 10), 15), 21), 26) and 27) herein shall survive the expiration or termination of this Agreement for any reason.
22. **EXPORT RESTRICTIONS.** Licensee agrees that Licensee will comply with all export control legislation of Canada, the United States, Australia and any other applicable country's laws and regulations, whether under the Arms Export Control Act, the International Traffic in Arms Regulations, the Export Administration Regulations, the regulations of the United States Departments of Commerce, State, and Treasury, or otherwise as well as the export control legislation of all other countries.
23. **PRODUCT COMPONENTS.** The Product may contain third party components. Those third party components may be subject to additional terms and conditions. Licensee is required to agree to those terms and conditions in order to use the Product.
24. **FORCE MAJEURE EVENT.** Neither party will have the right to claim damages as a result of the other's inability to perform or any delay in performance due to unforeseeable circumstances beyond its reasonable control, such as labor disputes, strikes, lockouts, war, riot, insurrection, epidemic, Internet virus attack, Internet failure, supplier failure, act of God, or governmental action not the fault of the non-performing party.
25. **FORUM FOR DISPUTES.** The parties agree that the courts located in the State of Arizona and the courts of appeal there from will have exclusive jurisdiction to resolve any disputes between Licensee and Hemisphere concerning this Agreement or Licensee's use or inability to use the Software and the parties hereby irrevocably agree to attorn to the jurisdiction of those courts. Notwithstanding the foregoing, either party may apply to any court of competent jurisdiction for injunctive relief.
26. **APPLICABLE LAW.** This Agreement shall be governed by the laws of the State of Arizona, exclusive of any of its choice of law and conflicts of law jurisprudence.
27. **CISG.** The United Nations Convention on Contracts for the International Sale of Goods will not apply to this Agreement or any transaction hereunder.
28. **GENERAL.** This is the entire agreement between Licensee and Hemisphere relating to the Product and Licensee's use of the same, and supersedes all prior, collateral or contemporaneous oral or written representations, warranties or agreements regarding the same. No amendment to or modification of this Agreement will be binding unless in writing and signed by duly authorized representatives of the parties. Any and all terms and conditions set out in any correspondence between the parties or set out in a purchase order which are different from or in addition to the terms and conditions set forth herein, shall have no application and no written notice of same shall be required. In the event that one or more of the provisions of this Agreement is found to be illegal or unenforceable, this Agreement shall not be rendered inoperative but the remaining provisions shall continue in full force and effect.

Warranty Notice

COVERED PRODUCTS: This warranty covers all products manufactured by Hemisphere GNSS and purchased by the end purchaser (the "Products"), unless otherwise specifically and expressly agreed in writing by Hemisphere GNSS.

LIMITED WARRANTY: Hemisphere GNSS warrants solely to the end purchaser of the Products, subject to the exclusions and procedures set forth below, that the Products sold to such end purchaser and its internal components shall be free, under normal use and maintenance, from defects in materials, and workmanship and will substantially conform to Hemisphere GNSS' applicable specifications for the Product, for a period of 12 months from delivery of such Product to such end purchaser (the "Warranty Period"). Repairs and replacement components for the Products are warranted, subject to the exclusions and procedures set forth below, to be free, under normal use and maintenance, from defects in material and workmanship, and will substantially conform to Hemisphere GNSS' applicable specifications for the Product, for 90 days from performance or delivery, or for the balance of the original Warranty Period, whichever is greater.

EXCLUSION OF ALL OTHER WARRANTIES. The LIMITED WARRANTY shall apply only if the Product is properly and correctly installed, configured, interfaced, maintained, stored, and operated in accordance with Hemisphere GNSS' relevant User's Manual and Specifications, AND the Product is not modified or misused. The Product is provided "AS IS" and the implied warranties of MERCHANTABILITY and FITNESS FOR A PARTICULAR PURPOSE and ALL OTHER WARRANTIES, express, implied or arising by statute, by course of dealing or by trade usage, in connection with the design, sale, installation, service or use of any products or any component thereof, are EXCLUDED from this transaction and shall not apply to the Product. The LIMITED WARRANTY is IN LIEU OF any other warranty, express or implied, including but not limited to, any warranty of MERCHANTABILITY or FITNESS FOR A PARTICULAR PURPOSE, title, and non-infringement.

LIMITATION OF REMEDIES. The purchaser's EXCLUSIVE REMEDY against Hemisphere GNSS shall be, at Hemisphere GNSS' option, the repair or replacement of any defective Product or components thereof. The purchaser shall notify Hemisphere GNSS or a Hemisphere GNSS' approved service center immediately of any defect. Repairs shall be made through a Hemisphere GNSS approved service center only. Repair, modification or service of Hemisphere GNSS products by any party other than a Hemisphere GNSS approved service center shall render this warranty null and void. The remedy in this paragraph shall only be applied in the event that the Product is properly and correctly installed, configured, interfaced, maintained, stored, and operated in accordance with Hemisphere GNSS' relevant User's Manual and Specifications, AND the Product is not modified or misused. NO OTHER REMEDY (INCLUDING, BUT NOT LIMITED TO, SPECIAL, INDIRECT, INCIDENTAL, CONSEQUENTIAL OR CONTINGENT DAMAGES FOR LOST PROFITS, LOST SALES, INJURY TO PERSON OR PROPERTY, OR ANY OTHER INCIDENTAL OR CONSEQUENTIAL LOSS) SHALL BE AVAILABLE TO PURCHASER, even if Hemisphere GNSS has been advised of the possibility of such damages. Without limiting the foregoing, Hemisphere GNSS shall not be liable for any damages of any kind resulting from installation, use, quality, performance or accuracy of any Product.

HEMISPHERE IS NOT RESPONSIBLE FOR PURCHASER'S NEGLIGENCE OR UNAUTHORIZED USES OF THE PRODUCT. IN NO EVENT SHALL HEMISPHERE GNSS BE IN ANY WAY RESPONSIBLE FOR ANY DAMAGES RESULTING FROM PURCHASER'S OWN NEGLIGENCE, OR FROM OPERATION OF THE PRODUCT IN ANY WAY OTHER THAN AS SPECIFIED IN HEMISPHERE GNSS' RELEVANT USER'S MANUAL AND SPECIFICATIONS. Hemisphere GNSS is NOT RESPONSIBLE for defects or performance problems resulting from (1) misuse, abuse, improper installation, neglect of Product; (2) the utilization of the Product with hardware or software products, information, data, systems, interfaces or devices not made, supplied or specified by Hemisphere GNSS; (3) the operation of the Product under any specification other than, or in addition to, the specifications set forth in Hemisphere GNSS' relevant User's Manual and Specifications; (4) damage caused by accident or natural events, such as lightning (or other electrical discharge) or fresh/salt water immersion of Product; (5) damage occurring in transit; (6) normal wear and tear; or (7) the operation or failure of operation of any satellite-based positioning system or differential correction service; or the availability or performance of any satellite-based positioning signal or differential correction signal.

THE PURCHASER IS RESPONSIBLE FOR OPERATING THE VEHICLE SAFELY. The purchaser is solely responsible for the safe operation of the vehicle used in connection with the Product, and for maintaining proper system control settings. UNSAFE DRIVING OR SYSTEM CONTROL SETTINGS CAN RESULT IN PROPERTY DAMAGE, INJURY, OR DEATH. The purchaser is solely responsible for his/her safety and for the safety of others. The purchaser is solely responsible for maintaining control of the automated steering system at all times. THE PURCHASER IS SOLELY RESPONSIBLE FOR ENSURING THE PRODUCT IS PROPERLY AND CORRECTLY INSTALLED, CONFIGURED, INTERFACED, MAINTAINED, STORED, AND OPERATED IN ACCORDANCE WITH HEMISPHERE GNSS' RELEVANT USER'S MANUAL AND SPECIFICATIONS. Hemisphere GNSS does not warrant or guarantee the positioning and navigation precision or accuracy obtained when using Products. Products are not intended for primary navigation or for use in safety of life applications. The potential accuracy of Products as stated in Hemisphere GNSS literature and/or Product specifications serves to provide only an estimate of achievable accuracy based on performance specifications provided by the satellite service operator (i.e. US Department of Defense in the case of GNSS) and differential correction service provider. Hemisphere GNSS reserves the right to modify Products without any obligation to notify, supply or install any improvements or alterations to existing Products.

GOVERNING LAW. This agreement and any disputes relating to, concerning or based upon the Product shall be governed by and interpreted in accordance with the laws of the State of Arizona.

OBTAINING WARRANTY SERVICE. In order to obtain warranty service, the end purchaser must bring the Product to a Hemisphere GNSS approved service center along with the end purchaser's proof of purchase. Hemisphere GNSS does not warrant claims asserted after the end of the warranty period. For any questions regarding warranty service or to obtain information regarding the location of any of Hemisphere GNSS approved service center, contact Hemisphere GNSS at the following address:

Hemisphere GNSS

8444 N. 90th Street, Suite 120

Scottsdale, AZ 85258

Phone: 480-348-9919 Fax: 480-348-6370

techsupport@hemispheregps.com



www.hemispheregps.com